



GENERAL SERVICES ADMINISTRATION
Federal Supply Service
FSC Group: 71 Part 1, Office Furniture

Inscape System

Authorized Federal Supply Schedule Price List

Updated for Mod # TBA, Dated TBA

Inscape System encompasses Systems / Bench / Tables / Veil

GSA Contract # **GS-03F-038DA**

Contract Period: December 22, 2015 - December 21, 2020

Current to supplement number: 4

Business size: Small

For more information on ordering from Federal Supply Schedules, click on the FSS Schedules button at fss.gsa.gov.

On-line access to contract ordering information, terms and conditions, up-to-date pricing, and the option to create an electronic delivery order are available through GSA Advantage!, a menu-driven database system.

The INTERNET address for GSA Advantage! is www.GSAAvantage.gov.

GS-03F-038DA

Inscape Inc
U.S. Headquarters
221 Lister Avenue
Falconer, NY 14733
Telephone: 716 665 6210
Email: GovTeam@inscapesolutions.com
www.inscapesolutions.com/products/government

Left blank intentionally.

Conditions of sale 007

system

Architecture 011

Frames & screens	012	Connectors & trim	033	Tiles	054
+ General information	012	+ General information	033	+ General information	054
+ 3 ½" Thick	014	+ 3 ½" Thick	035	+ Painted	056
– Standard Frames	014	– Trim	035	+ Fabric	057
+ 3 ½" Thick	015	– 90° Connector Kits	036	+ Tackable	058
– Basic Frames	015	– 90° Same Height Connector Kits	037	+ Nuform	059
– Stack-on Frames	017	– 90° Stack-on Connector Kits	038	+ Nuform Patterned	060
– Double Glazed Stack-on Frames	018	– 90° Multi Height Connector Kits	039	+ Composite Veneer	061
+ 2 ¾" Thick	019	– 120° Connector Kits	040	+ Whiteboard	062
– Standard Frames	019	+ 2 ¾" Thick	041	+ Paper Management	063
– Basic Frames	020	– Trim	041	+ Paper Management Tile	
– Stack-on Frames	022	– 90° Connector Kits	042	Reinforcing Kit	064
– Double Glazed Stack-on Frames	023	– 90° Same Height Connector Kits	043	+ Perforated	065
+ 1 ½" Thick	024	– 90° Stack-on Connector Kits	044	+ Communication - Painted	066
– Segmented Screens	024	– 90° Multi Height Connector Kits	045	+ Communication - Fabric	067
– Glazed Segmented Screens	025	– 120° Connector Kits	046	+ Multi Access - Painted	068
– Monolithic Screens	026	+ 1 ½" Thick Screen Connectors	047	+ Multi Access - Fabric	069
– Accessory Screens	028	– Screen Connectors	047	+ Double Glazed	070
– Freestanding Screens	029	+ 1 ½" Screen to 3 ½" Frame		+ Monolithic - Painted	071
– Table Mounted Screens	030	Connector Kits	048	+ Monolithic - Fabric	072
– Open Electrified Storage Frame	031	+ 2 ¾" Frame to 3 ½" Frame		+ Monolithic with Multi Access	
+ Sliding Doors	032	Same Height Connector Kits	050	– Painted	073
		+ ADDWALL to Frame		+ Monolithic with Multi Access	
		Connector Bracket	051	– Fabric	074
		+ Planna Storage Benching End Trim	052	+ Planna Storage Benching	
		+ Frame to Storwal Storage		Multi Access	075
		Components	053		

Technology 077

General information	078	Power Tracks	086	Worksurfaces Technology	
Power In Feeds	081	Jumper Cables	087	Components	092
+ Floor/Wall	081			Power and Data Accessories	093
+ Ceiling Power Pole Kits	082	Receptacles	088	Storwal Components	094
+ Chimney Power Feed Frame	083	+ USB Power Modules	089		
Frame Components	084	Task Lights	090		
+ Chicago Electrical Components	084	Data Components	091		
+ Beltline Cover Kits	085				

Worksurfaces 097

Panel Mounted Worksurfaces	098	Transaction tops	114
+ General information	098	+ General information	114
+ Rectangular Tops	099	+ For 3 ½" Thick Frames	115
+ Reducing Tops	100	+ For 2 ¾" Thick Frames	116
+ Saddle Tops	101	Supports	117
+ Galley Tops	102	+ General information	117
+ Funnel Tops	103	+ Panel Mounted Worksurface	
+ Radiused Tops	104	Supports	118
+ Standard Corners	105	+ Worksurface Supports	121
+ Extended Corners	106	+ Storwal and Planna Worksurface	
+ 120° Corners	108	Support Brackets	122
+ Conference Tops	109	+ Legs and Leg Docking Brackets	123
+ Height Adjustable Worksurfaces	110	+ 1 ½" Screen Worksurfaces	
+ Storwal Rectangular Tops	111	Docking Brackets	126
+ Storwal Saddle Tops	112	+ ADDWALL Worksurfaces	
+ Storwal Galley Tops	113	Support Brackets	127

Storage 129

Pedestals	130	Towers	151	Planna Storage	171
+ General information	130	+ General information	151	+ Base Modules	171
– Pedestals with Flat Glides	132	+ 7900 Series Front	152	– Lateral	171
– Pedestals with Rectangular Glides	133	– Workplace Towers	152	– Hinged Door	173
– Mobile Pedestals	134	+ 9900 Series Front	153	– Pedestal	174
+ 9900 Series Front	135	– Workplace Towers	153	+ Sliding Doors	175
– Pedestals with Flat Glides	135	– Wardrobes	154	+ Benching End Trim	176
– Pedestals with Rectangular Glides	136	+ Nuform Front	156		
– Mobile Pedestals	137	– Wardrobes	156	Storwal Storage	178
+ Nuform Front	138			+ Base Modules	178
– Pedestals with Flat Glides	138	Overhead storage	158	– Open Bookcase	178
+ Composite Veneer Front	139	+ General information	158	– 9900 Series Front	179
– Pedestals with Flat Glides	139	+ Storage Bins	160	– Nuform Front	181
+ Pedestal Brackets	140	+ Hinged Door and Up-Mount Bins	161	– Composite Veneer Front	182
		+ Storage Bin Brackets	162	+ Stack Units	183
Laterals	141	+ Up-Mount Bin Supports		– 16 3/8" H	183
+ General information	141	and Brackets	163	– 29 7/8" H	184
+ 7900 Series Front	143	+ Shelves + Brackets	164	– 35 7/8" H	186
– Laterals with Flat Glides	143	+ Up-Mount Bin Accessories	165	+ Wardrobe Towers	188
– Laterals with Rectangular Glides	144	+ Twin-Bins	167	– 51" H	188
+ 9900 Series Front	145	+ Twin-Bin Brackets	168	– 64" H	192
– Laterals with Flat Glides	145	+ Twin-Bin Accessories	169	– 71" H	196
– Laterals with Rectangular Glides	146				
+ Nuform Front	147				
– Laterals with Flat Glides	147				
+ Composite Veneer Front	148				
– Laterals with Flat Glides	148				
+ Lateral Brackets	149				

Accessories 199

General information	200	Planna Storage	229
Horizontal	204	+ Brackets and Rails	229
Panel and Table	205	+ Pedestals and Lateral Tops	230
Modesty Panel	208	+ Tops to Accommodate Benching Electrical	231
Privacy Screens	211	Storwal Storage	232
Add-on Glazing	212	+ Worksurfaces Support Bracket	232
+ 3 1/2" T	212	+ Tackboards	233
+ 2 3/4" T	214	+ Whiteboards	234
Wall Mounted	217	– Not Adjacent to Sliding Doors	234
Storage	218	– Adjacent to Sliding Doors	235
Overhead Storage	219	+ Back Painted Glass Whiteboards	236
Electrified Twin-Bin	220	+ Case Accessories	237
Twin Bin	221	+ Adapter Frames	239
Pedestal	222	+ Frame to Storwal Components	240
Lateral	223	+ Lateral Tops	241
Back Painted Glass	225		
SuperStor™	226		
Cushions	227		

bench

Architecture 245

General information	247	Connectors and Trim	254
Spines	249	Tiles	256
+ Spine Frames	249	+ Full Height Spine Tiles	256
+ Stack-on Frames	251	+ Partial Height Spine Tiles	257
+ Spine Support Legs	252	+ 10.125" H Stack-On Tiles	261

Technology 263

General information	264	Electrical Components	267	Power and Data Accessories	269
Power In Feeds	266	Data Components	268	Electrical Accessories	270

Worksurfaces 271

General information	273	Perpendicular worksurface	282	Worksurfaces Supports	288
Rectangular Tops	275	120° Worksurface	283	+ Perpendicular Application	289
+ Middle Application	275	+ Middle Application	283	+ Full Gable	291
+ Full End Gable Application	276	+ Full End Gable Application	284	+ Full Gable Brackets	292
+ Open End Leg Application	277	+ Open End Leg Application	285	+ Open H Leg	293
+ End Storage Application	278	Height Adjustable Worksurface	286	+ Open O Leg	295
Electrical Access Worksurface	279	+ Manual Pneumatic	286	+ For Electric Height Adjustable Application Only	296
+ Middle Application	279	+ Electric	287	Worksurface Top Filler Cap	297
+ Full End Gable Application	280				
+ Open End Leg Application	281				

Storage 299

General information	300	Laterals	305	Twin-Bins and Brackets	308
Pedestals	303	+ 7900 Series Front	305	Twin-Bin Accessories	309
+ 7900 Series Front	303	+ 9900 Series Front	306	Trading Desk	310
+ 9900 Series Front	304	Bookcases	307		

Accessories 311

General information	313	Open leg Accessories	321	The Arrivals Collection	327
Spine Accessories	314	Worksurface Dividers	323	+ Screens	327
+ Up-Mount Bins	315	Laminate Divider Accessories	325	+ Upmont Shelves	328
+ Add-on Glazing	317	Collaborative Collection	326	+ Replacement Fabric Skins	329
+ Spine Divider with Accessory Rail	319			+ Transaction Tops	331
+ Spine Tackable Divider	320				

tables

Arrivals Tables Collection 335

Standing Height Tables	336	Meeting Tables	337	Coffee Tables	338
-------------------------------	------------	-----------------------	------------	----------------------	------------

Worksurfaces 339

Square and Rectangular Tops	341	Semi-circle Tops	344	Hex, Pebble and Rhombus Tops	347
Racetrack and Boat Tops	342	Quarter-circle Tops	345	Rectangular Tops with Power Module	348
Round Tops	343	Trapezoid Tops	346	Bullet, Bean, Oval and Curved Rectangular Tops	349

Legs & Bases 351

Legs	352	Bases	354
-------------	------------	--------------	------------

Accessories 355

Surface Support Accessories	356	Modesty Panels	358
Table Mounted Screens	357	Electrical Accessories	363

Contents

veil

Privacy screens 367

Seating 369

Finishes

Care and
maintenance

Refer to the [Conditions of Sale](#) document on inscapesolutions.com.

Left blank intentionally.

System
US Price List
September 2018

Left blank intentionally.

system

Architecture

System

Architecture

Frames & screens

General information

General information

Inscape System frames are constructed of 16 gauge tubular steel uprights with welded 18 gauge steel crossrails. This strong yet lightweight construction provides ease of movement and reconfiguration.

The simplicity of the frame structure provides an intelligent solution to cable management. The absence of baseplates, apertures and corner posts eliminate barriers that restrict the routing of cables. Cabling may be routed both vertically and horizontally through the panel. Cables are laid into cable managers that easily install between panel crossrails throughout the framework. Cable managers safely cradle and segregate cables. An aperture free system means installation and reconfiguration costs are kept to a minimum. Cabling may also enter the system through the top or face of the panel. Reconfiguration is easy and economical. Cabling simply eases out of the cable managers and is laid back in at the desired point, eliminating the costly need to cut and re-terminate cables for every reconfiguration. Panels do not have creep.

3 1/2" Thick frame

The 3 1/2" Thick Frame accommodates approximately 96 Cat6 or 125 Cat5 cables per 13.5" zone at a fill capacity of 60% between the upright and the tile. Frames and frame specific components for the 3.5" thick frame are denoted by the suffix "-3F".

2 3/4" Thick frame

The 2 3/4" Thick Frame accommodates approximately 52 Cat6 or 67 Cat5 cables per 13.5" zone at a fill capacity of 60% between the upright and the tile. Frames and frame specific components for the 2.75" thick frame are denoted by the suffix "-2F".

Standard frame

A Standard Frame has a beltline cover kit enabling power to run at the beltline location without the need of a "cut out" tile. Standard frames are available for both the 3.5" and 2.75" thick frames. Frames 37" and higher come equipped with one wire manager. Electrical and data components must be specified separately. Standard heights that are available include 37", 44", 51", 57" and 64".

NOTE: Tiles cannot be placed over the cover kit on a 2 3/4" thick frame. The Cover Kit frame clip cannot accommodate a tile hanging from the clip. Note: 27" h tiles cannot be mounted in bottom position on a 2 3/4" thick standard frame.

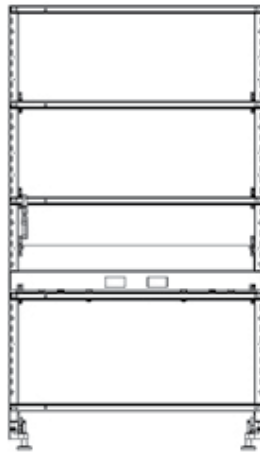

Basic frames

Basic Frames do not include the electrical cover kit but may house power which is to be accessed at all locations with a "cut out" tile. Basic frames 37" and higher come with one wire manager. Basic frames are available for both the 3.5" and 2.75" thick frames. Basic heights available include 24", 29", 37", 44", 51", 57" and 64". The 3 1/2" thick frame by 24" h includes the mounting hardware to attach to a Credenza Storage case when used in a benching application.

Both types of frames feature glides that



provide 1 1/2" height adjustment allowing air to circulate under panels and throughout the office. Frames are available in 6" increments in widths ranging from 18" wide to 60" wide.

Stack on frame

The Stack on Frame consists of a 6.75", 13.5", 20.25" and 27" frame which may be installed on a Standard or Basic frame of the same width or combination of two frames as outlined in the Inscape System Application Guide only. The Stack on frame is load bearing to one storage unit above 64" height and may be stacked up to 91" h. Tiles and trim are specified separately. The top cap from the base frame may be used on the stack on frame. Stack on frames are frame thickness specific and should be specified accordingly.

Double glazed stack-on kit

Double Glazed Stack-On Kit is a stack on frame with a double glazed insert. The 24" to 60" wide Double Glazed Stack is a fully welded frame stack on. Double Glazed Stacks which are 54" and wider are kitted and are installed on site. The Double Glazed Stack on is not load bearing and no stacks can be stacked on top of the Double Glaze. Stack on frames are frame thickness specific and should be specified accordingly. Finishes are available in Clear or Frosted Acrylic to match Double Glazed tile.

		Dimensions			
		A	B	C	D
SYSTEM	TRIM	TOP CAP TO TOP TILE	TOP TILE TO BOTTOM TILE	BOTTOM TILE TO FLOOR*	FLOOR TO CANTILEVER
INSCAPE SYSTEM	Tapered	1.1	24" h = 20.050	1.843	27.24
			29" h = 26.800		
			37" h = 33.550		
	Flat	0.65	44" h = 40.300		
			51" h = 47.050		
			57" h = 53.800		
		64" h = 60.550			

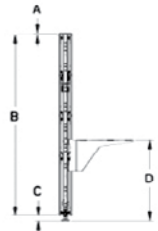

Note: Dimensions 'C' & 'D' measured with frames at lowest glide position. Frame can be raised up to 1.500" depending on configuration and leveling.

1 1/2" thick screen

The 1.5" Thick Screen is available in a freestanding version or one that is intended to be joined to adjacent screens. The screen is inclusive of a finished frame, 1/2" tackable core (fabric option) and glides. Various configurations of the segmented or monolithic screen are available including all fabric, fabric with acrylic or resin and polycarbonate. Whiteboard accessories should follow the same guidelines as the Whiteboard tile. No assembly is required with the screen.

Table mounted screen

The Table Mounted Screen is constructed of a 1.5" thick extruded aluminum frame and is designed to provide modesty and privacy to adjacent work areas. This 37" high screen mounts onto a 1" or 1.25" thick worksurface and may be adjusted vertically to create the desired privacy or modesty. The tackable 1/2" thick core may be specified in any of Inscape's standard fabrics or COM. Height adjustable brackets allow for various screen height positions. It is recommended that the table mounted screen be installed 20" above the surface with 16" below. Table mounted screens cannot be attached to 1.5" thick screen brackets attaching to thicker frames.

1 1/2" electrified storage frame

The 1.5" Electrified Storage Frame is an open structure frame which is positioned between Electrified Storage units to allow technology to run through when a 1 1/2" connection is required and a 1 1/2" screen is to run perpendicular to Electrified Storage spine.

Inscape system sliding door

Inscape System Sliding Door is a 1 ½" thick extruded aluminum frame which is available to match 51" and 64" panel heights and openings of 36" and 42". The sliding door includes a door assembly consisting of door trim, polycarbonate panel, two door pulls, two 2.5" adjustable wheels and top/bottom connector brackets to attach to the panel frame. A locking version is available and is secured in the closed position by a lock at the opposite side of the handle. Polycarbonate has naturally occurring variations in the material. The tile configuration must be such that the crossrail at 37" high is accessible where the lock mechanism is located. See Inscape System Application Guide.

The 36" wide sliding door is installed on any panel or combination of panels 42" in width.

The 42" wide sliding door is installed on any panel or combination of panels 48" in width.

Sliding Doors are handed and need to be specified left or right for the direction in which the door is required to slide once installed on the front of the workstation.



NOTE: Tapered vertical trim is available in any of the colors shown in our current Paint Canr and Fans plus textured paint finishes.

If you don't find your configuration listed as standard product, send your request to specials@inscapesolutions.com with a copy of the connection layout.

General information

To facilitate specification of connector kits for various multi-height panel configurations, preconfigured connector kits have been created. Connector kits include all the vertical trims, connectors, plugs and plates required to make and complete the connection at the junction point.

The panel configurations shown on the following pages have been grouped according to the type of connection: 'L' Connection (two-way 90°), 'T' Connection (three-way 90°), 'X' Connection (four-way 90°), 'V' Connection (two-way 120°) and 'Y' Connection (three-way 120°). Identify the desired connection and panel configuration and specify connectors as outlined below. A variety of panel configurations are shown on the following pages. Some configurations have more than one product code. An explanation of the product codes follow:

Product code key example

INCPT5053

INCP	panel connector
T	three-way connection
5	51" high panel
0	no panel
5	51" high panel
3	37" high panel



The prefix to the four digits in the product number represent the following: 'CP'-panel connector, 'L'-2-way connection, 'T'-3 way connection, 'X'-4-way connection, 'V'-2-way 120°connection and 'Y'-3- way 120°connection. The four digits represent the different heights of panels to be connected. Heights are represented by the first digit.

- 64" high panel -6
- 51" high panel-5
- 37" high panel -3

To specify the correct panel junction, start with the highest panel and move clockwise. For example: To specify a 3-way connection comprised of 51" high and 37"high panels, start with the highest panel, 51" - 5. Proceed clockwise, 0 for no panels, 5 for 51" and 3 for 37". The code is 5053.

Finishes

Vertical trims are available in any of the colors shown in our current Paint Card and Fans plus textured paint and veneer trim finishes.

System

Architecture

Frames and Screens

3 1/2" Thick Standard Frames

Product code key example:

INOF348-3F





INOF Inscape System Frame
3 37" high
48 48" wide
3F 3 1/2" thick frame w/ electrical cover plate

General information

- Includes electrical cover kit at the beltline location painted in Eco Black
- 2" deep glide cap color of black or gray (gray default)
- 1 wire manager hanger included with frame
- Compatible with electrical launched December 2010 only
- A Beltline power track is to be specified in the beltline location
- Rectangular glides available for an upcharge of \$11 per frame

Notes

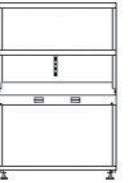
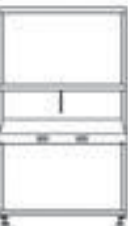
- **18"-24" wide frames do not come with electrical cutouts**
- **30" wide frames come with only 1 cutout**
- **Top caps are to be ordered separately**

Description	Part number	Height	Width	Thickness	List Price
 37" H Standard Frame	INOF318-3F	37"	18"	3 1/2"	\$275
	INOF324-3F	37"	24"	3 1/2"	\$280
	INOF330-3F	37"	30"	3 1/2"	\$294
	INOF336-3F	37"	36"	3 1/2"	\$300
	INOF342-3F	37"	42"	3 1/2"	\$305
	INOF348-3F	37"	48"	3 1/2"	\$310
	INOF354-3F	37"	54"	3 1/2"	\$313
 44" H Standard Frame	INOF418-3F	44"	18"	3 1/2"	\$301
	INOF424-3F	44"	24"	3 1/2"	\$302
	INOF430-3F	44"	30"	3 1/2"	\$306
	INOF436-3F	44"	36"	3 1/2"	\$313
	INOF442-3F	44"	42"	3 1/2"	\$320
	INOF448-3F	44"	48"	3 1/2"	\$326
	INOF454-3F	44"	54"	3 1/2"	\$328
 51" H Standard Frame	INOF518-3F	51"	18"	3 1/2"	\$315
	INOF524-3F	51"	24"	3 1/2"	\$320
	INOF530-3F	51"	30"	3 1/2"	\$328
	INOF536-3F	51"	36"	3 1/2"	\$338
	INOF542-3F	51"	42"	3 1/2"	\$346
	INOF548-3F	51"	48"	3 1/2"	\$361
	INOF554-3F	51"	54"	3 1/2"	\$365
 57" H Standard Frame	INOF5718-3F	57"	18"	3 1/2"	\$336
	INOF5724-3F	57"	24"	3 1/2"	\$345
	INOF5730-3F	57"	30"	3 1/2"	\$352
	INOF5736-3F	57"	36"	3 1/2"	\$368
	INOF5742-3F	57"	42"	3 1/2"	\$378
	INOF5748-3F	57"	48"	3 1/2"	\$393
	INOF5754-3F	57"	54"	3 1/2"	\$397
 64" H Standard Frame	INOF618-3F	64"	18"	3 1/2"	\$351
	INOF624-3F	64"	24"	3 1/2"	\$362
	INOF630-3F	64"	30"	3 1/2"	\$372
	INOF636-3F	64"	36"	3 1/2"	\$388
	INOF642-3F	64"	42"	3 1/2"	\$402
	INOF648-3F	64"	48"	3 1/2"	\$417
	INOF654-3F	64"	54"	3 1/2"	\$421
INOF660-3F	64"	60"	3 1/2"	\$436	

Product code key example:

INOF348-3NPF



INOF Inscape System Frame
3 37" high
48 48" wide
3NPF 3 1/2" thick frame non powered

General information

- 2" deep glide cap color of black or gray (gray default)
- 24"h frame is equipped with hardware to attach to storage case
- 1 wire manager hanger included with frame
- Compatible with electrical launched after December 2010 only
- If powering a Basic frame, an Upper Deck power track kit is to be specified for all locations in the 3.5" thick frame
- Rectangular glides available for an upcharge of \$11 per frame

Notes

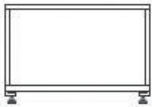
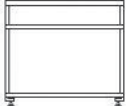
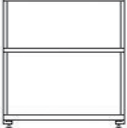
- **Top caps are to be ordered separately**

Description	Part number	Height	Width	Thickness	List Price
 24" H Basic Frame	INOF2418-3NPF	24"	18"	3 1/2"	\$156
	INOF2424-3NPF	24"	24"	3 1/2"	\$160
	INOF2430-3NPF	24"	30"	3 1/2"	\$168
	INOF2436-3NPF	24"	36"	3 1/2"	\$172
	INOF2442-3NPF	24"	42"	3 1/2"	\$175
	INOF2448-3NPF	24"	48"	3 1/2"	\$177
	INOF2454-3NPF	24"	54"	3 1/2"	\$180
 29" H Basic Frame	INOF218-3NPF	29"	18"	3 1/2"	\$197
	INOF224-3NPF	29"	24"	3 1/2"	\$199
	INOF230-3NPF	29"	30"	3 1/2"	\$211
	INOF236-3NPF	29"	36"	3 1/2"	\$214
	INOF242-3NPF	29"	42"	3 1/2"	\$217
	INOF248-3NPF	29"	48"	3 1/2"	\$219
	INOF254-3NPF	29"	54"	3 1/2"	\$221
 37" H Basic Frame	INOF318-3NPF	37"	18"	3 1/2"	\$206
	INOF324-3NPF	37"	24"	3 1/2"	\$211
	INOF330-3NPF	37"	30"	3 1/2"	\$220
	INOF336-3NPF	37"	36"	3 1/2"	\$223
	INOF342-3NPF	37"	42"	3 1/2"	\$227
	INOF348-3NPF	37"	48"	3 1/2"	\$228
	INOF354-3NPF	37"	54"	3 1/2"	\$230
 44" H Basic Frame	INOF418-3NPF	44"	18"	3 1/2"	\$231
	INOF424-3NPF	44"	24"	3 1/2"	\$234
	INOF430-3NPF	44"	30"	3 1/2"	\$236
	INOF436-3NPF	44"	36"	3 1/2"	\$240
	INOF442-3NPF	44"	42"	3 1/2"	\$244
	INOF448-3NPF	44"	48"	3 1/2"	\$248
	INOF454-3NPF	44"	54"	3 1/2"	\$252
 51" H Basic Frame	INOF518-3NPF	51"	18"	3 1/2"	\$246
	INOF524-3NPF	51"	24"	3 1/2"	\$249
	INOF530-3NPF	51"	30"	3 1/2"	\$254
	INOF536-3NPF	51"	36"	3 1/2"	\$259
	INOF542-3NPF	51"	42"	3 1/2"	\$268
	INOF548-3NPF	51"	48"	3 1/2"	\$278
	INOF554-3NPF	51"	54"	3 1/2"	\$282
INOF560-3NPF	51"	60"	3 1/2"	\$289	

System

Architecture

Frames and Screens

3 1/2" Thick Basic Frames

Product code key example:

INOF648-3NPF



INOF Inscape System Frame
6 64" high
48 48" wide
3NPF 3 1/2" thick frame non powered

General information

- 2" deep glide cap color of black or gray (gray default)
- 24"h frame is equipped with hardware to attach to storage case
- 1 wire manager hanger included with frame
- Compatible with electrical launched after December 2010 only
- If powering a Basic frame, an Upper Deck power track kit is to be specified for all locations in the 3.5" thick frame
- Rectangular glides available for an upcharge of \$11 per frame

Notes

- **Top caps are to be ordered separately**

Description	Part number	Height	Width	Thickness	List Price
 <p>57" H Basic Frame</p>	INOF5718-3NPF	57"	18"	3 1/2"	\$269
	INOF5724-3NPF	57"	24"	3 1/2"	\$276
	INOF5730-3NPF	57"	30"	3 1/2"	\$279
	INOF5736-3NPF	57"	36"	3 1/2"	\$290
	INOF5742-3NPF	57"	42"	3 1/2"	\$300
	INOF5748-3NPF	57"	48"	3 1/2"	\$308
	INOF5754-3NPF	57"	54"	3 1/2"	\$310
	INOF5760-3NPF	57"	60"	3 1/2"	\$322
 <p>64" H Basic Frame</p>	INOF618-3NPF	64"	18"	3 1/2"	\$285
	INOF624-3NPF	64"	24"	3 1/2"	\$294
	INOF630-3NPF	64"	30"	3 1/2"	\$295
	INOF636-3NPF	64"	36"	3 1/2"	\$310
	INOF642-3NPF	64"	42"	3 1/2"	\$325
	INOF648-3NPF	64"	48"	3 1/2"	\$333
	INOF654-3NPF	64"	54"	3 1/2"	\$334
	INOF660-3NPF	64"	60"	3 1/2"	\$348

Product code key example:

INSF048-3F





INSF Inscape System Stack-on Frame
0 6.75" high
48 48" wide
3F 3 1/2" thick frame

General information

- Fully welded stack on kits easily installed and removed to adjust panel heights
 - Load bearing – only one overhead unit on frame higher than 64"h
 - Stack on frames may span multiple frames
- *See Application Guide for spanning guidelines

Notes

- **Be sure to specify correct thickness of stack frame based on the frame it is being installed on**
- **May be stacked up to 91" high**

Description	Part number	Height	Width	Thickness	List Price
 6.75" H Single Stack-On	INSF018-3F	6.75"	18"	3 1/2"	\$135
	INSF024-3F	6.75"	24"	3 1/2"	\$139
	INSF030-3F	6.75"	30"	3 1/2"	\$140
	INSF036-3F	6.75"	36"	3 1/2"	\$143
	INSF042-3F	6.75"	42"	3 1/2"	\$146
	INSF048-3F	6.75"	48"	3 1/2"	\$151
	INSF054-3F	6.75"	54"	3 1/2"	\$152
INSF060-3F	6.75"	60"	3 1/2"	\$155	
 13.5" H Single Stack-On	INSF118-3F	13.5"	18"	3 1/2"	\$141
	INSF124-3F	13.5"	24"	3 1/2"	\$143
	INSF130-3F	13.5"	30"	3 1/2"	\$144
	INSF136-3F	13.5"	36"	3 1/2"	\$147
	INSF142-3F	13.5"	42"	3 1/2"	\$151
	INSF148-3F	13.5"	48"	3 1/2"	\$156
	INSF154-3F	13.5"	54"	3 1/2"	\$159
INSF160-3F	13.5"	60"	3 1/2"	\$160	
 20.25" H Single Stack-On	INSF2018-3F	20.25"	18"	3 1/2"	\$147
	INSF2024-3F	20.25"	24"	3 1/2"	\$152
	INSF2030-3F	20.25"	30"	3 1/2"	\$154
	INSF2036-3F	20.25"	36"	3 1/2"	\$159
	INSF2042-3F	20.25"	42"	3 1/2"	\$162
	INSF2048-3F	20.25"	48"	3 1/2"	\$165
	INSF2054-3F	20.25"	54"	3 1/2"	\$166
INSF2060-3F	20.25"	60"	3 1/2"	\$168	
 27" H Single Stack-On	INSF218-3F	27"	18"	3 1/2"	\$161
	INSF224-3F	27"	24"	3 1/2"	\$167
	INSF230-3F	27"	30"	3 1/2"	\$168
	INSF236-3F	27"	36"	3 1/2"	\$172
	INSF242-3F	27"	42"	3 1/2"	\$174
	INSF248-3F	27"	48"	3 1/2"	\$179
	INSF254-3F	27"	54"	3 1/2"	\$180
INSF260-3F	27"	60"	3 1/2"	\$181	

System

Architecture

Frames and Screens

3 1/2" Thick Double Glazed Stack-on Frames

Product code key example:

INSTGL24-3F

INST Inscape System stack-on frame
GL double glaze
24 24" wide
3F 3 1/2" thick frame

General information

- Clear and frosted acrylic options available
- Must only be installed in the top location
- Is not load bearing
- Stack on Double Glaze may span two frames. *See Application Guide for spanning guidelines
- 24" to 48" wide kits consist of welded frames
- 54" to 96" wide kits are kitted and must be assembled onsite

Notes

Be sure to specify correct thickness of stack frame based on the frame it is being installed on

In order to get a total cost on products when upcharges are present take the list price of the product number and add the upcharge cost shown to the list price.

For example:

Product INSTGL24-3F in Frosted Acrylic would be \$412 +\$71

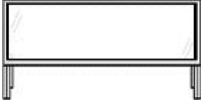
Description	Part number	Height	Width	Thickness	Clear acrylic	Frosted acrylic	Accent paint upcharge
 <p>13.5" H Double Glaze Stack-On Acrylic</p>	INSTGL24-3F	13.5"	24"	3 1/2"	\$412	+\$71	+\$42
	INSTGL30-3F	13.5"	30"	3 1/2"	\$463	+\$79	+\$47
	INSTGL36-3F	13.5"	36"	3 1/2"	\$529	+\$89	+\$54
	INSTGL42-3F	13.5"	42"	3 1/2"	\$573	+\$98	+\$58
	INSTGL48-3F	13.5"	48"	3 1/2"	\$633	+\$108	+\$64
	INSTGL54-3F	13.5"	54"	3 1/2"	\$693	+\$106	+\$71
	INSTGL60-3F	13.5"	60"	3 1/2"	\$752	+\$117	+\$76
	INSTGL66-3F	13.5"	66"	3 1/2"	\$811	+\$138	+\$82
	INSTGL72-3F	13.5"	72"	3 1/2"	\$835	+\$141	+\$85
	INSTGL78-3F	13.5"	78"	3 1/2"	\$859	+\$145	+\$87
	INSTGL84-3F	13.5"	84"	3 1/2"	\$884	+\$148	+\$89
INSTGL90-3F	13.5"	90"	3 1/2"	\$908	+\$154	+\$92	
INSTGL96-3F	13.5"	96"	3 1/2"	\$932	+\$158	+\$94	

Product code key example

INOF342 - 2F





INOF	Inscape System frame
3	37" high
42	42" wide
2F	2 3/4" thick standard frame

General information

- Includes electrical cover kit at the beltline location painted in Eco Black
- 2" deep glide cap color of black or gray (gray default)
- 1 wire manager hanger included with frame
- Compatible with electrical launched after December 2010 only
- A Beltline power track is to be specified in the beltline location
- See Application guide for restrictions with cabling
- Rectangular glides available for an upcharge of \$11 per frame

Notes

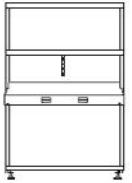
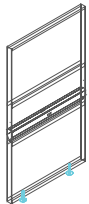
- **18"-24" wide frames do not come with electrical cut outs**
- **30" wide frames come with 1 electrical cutout**
- **27"h tiles cannot be mounted in bottom position on a 2.75" thick standard frame**
- **Tiles cannot be placed over cover kit (beltline location) on 2.75" frame**
- **Top caps are to be ordered separately**

Description	Part number	Height	Width	Thickness	List Price
	37" H Standard Frame				
	INOF318-2F	37"	18"	2 3/4"	\$275
	INOF324-2F	37"	24"	2 3/4"	\$280
	INOF330-2F	37"	30"	2 3/4"	\$294
	INOF336-2F	37"	36"	2 3/4"	\$300
	INOF342-2F	37"	42"	2 3/4"	\$305
	INOF348-2F	37"	48"	2 3/4"	\$310
	44" H Standard Frame				
	INOF418-2F	44"	18"	2 3/4"	\$301
	INOF424-2F	44"	24"	2 3/4"	\$302
	INOF430-2F	44"	30"	2 3/4"	\$306
	INOF436-2F	44"	36"	2 3/4"	\$313
	INOF442-2F	44"	42"	2 3/4"	\$320
	INOF448-2F	44"	48"	2 3/4"	\$326
	51" H Standard Frame				
	INOF518-2F	51"	18"	2 3/4"	\$315
	INOF524-2F	51"	24"	2 3/4"	\$320
	INOF530-2F	51"	30"	2 3/4"	\$328
	INOF536-2F	51"	36"	2 3/4"	\$338
	INOF542-2F	51"	42"	2 3/4"	\$346
	INOF548-2F	51"	48"	2 3/4"	\$361
	57" H Standard Frame				
	INOF518-2F	57"	18"	2 3/4"	\$336
	INOF524-2F	57"	24"	2 3/4"	\$345
	INOF530-2F	57"	30"	2 3/4"	\$352
	INOF536-2F	57"	36"	2 3/4"	\$368
	INOF542-2F	57"	42"	2 3/4"	\$378
	INOF548-2F	57"	48"	2 3/4"	\$393
	64" H Standard Frame				
	INOF618-2F	64"	18"	2 3/4"	\$351
	INOF624-2F	64"	24"	2 3/4"	\$362
	INOF630-2F	64"	30"	2 3/4"	\$372
	INOF636-2F	64"	36"	2 3/4"	\$388
	INOF642-2F	64"	42"	2 3/4"	\$402
	INOF648-2F	64"	48"	2 3/4"	\$417
INOF654-2F	64"	54"	2 3/4"	\$421	
INOF660-2F	64"	60"	2 3/4"	\$436	

System

Architecture

Frames and Screens

2 3/4" Thick Basic Frames

Product code key example

INOF342 - 2NPF





INOF	Inscape System frame
3	37" high
42	42" wide
2NPF	2 3/4" thick frame non powered

General information

- 2" deep glide cap color of black or gray (gray default)
- 24"h frame is equipped with hardware to attach to storage case
- 1 wire manager hanger included with frame
- Compatible with electrical launched after December 2010 only
- If powering a Basic frame, an Upper Deck power track kit is to be specified for all locations in the 2.75" thick frame
- Rectangular glides available for an upcharge of \$11 per frame

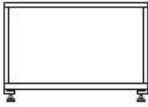
Notes

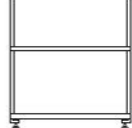
- **18"-24" wide frames do not come with electrical cut outs**
- **30" wide frames come with 1 electrical cutout**
- **Top caps are to be ordered separately**

Description	Part number	Height	Width	Thickness	List Price	
	24" H Basic Frame	INOF2418-2NPF	24"	18"	2 3/4"	\$156
		INOF2424-2NPF	24"	24"	2 3/4"	\$160
		INOF2430-2NPF	24"	30"	2 3/4"	\$168
		INOF2436-2NPF	24"	36"	2 3/4"	\$172
		INOF2442-2NPF	24"	42"	2 3/4"	\$175
		INOF2448-2NPF	24"	48"	2 3/4"	\$177
		INOF2454-2NPF	24"	54"	2 3/4"	\$180
	INOF2460-2NPF	24"	60"	2 3/4"	\$183	
	29" H Basic Frame	INOF218-2NPF	29"	18"	2 3/4"	\$197
		INOF224-2NPF	29"	24"	2 3/4"	\$199
		INOF230-2NPF	29"	30"	2 3/4"	\$211
		INOF236-2NPF	29"	36"	2 3/4"	\$214
		INOF242-2NPF	29"	42"	2 3/4"	\$217
		INOF248-2NPF	29"	48"	2 3/4"	\$219
		INOF254-2NPF	29"	54"	2 3/4"	\$221
	INOF260-2NPF	29"	60"	2 3/4"	\$223	
	37" H Basic Frame	INOF318-2NPF	37"	18"	2 3/4"	\$206
		INOF324-2NPF	37"	24"	2 3/4"	\$211
		INOF330-2NPF	37"	30"	2 3/4"	\$220
		INOF336-2NPF	37"	36"	2 3/4"	\$223
		INOF342-2NPF	37"	42"	2 3/4"	\$227
		INOF348-2NPF	37"	48"	2 3/4"	\$228
		INOF354-2NPF	37"	54"	2 3/4"	\$230
	INOF360-2NPF	37"	60"	2 3/4"	\$234	
	44" H Basic Frame	INOF418-2NPF	44"	18"	2 3/4"	\$231
		INOF424-2NPF	44"	24"	2 3/4"	\$234
		INOF430-2NPF	44"	30"	2 3/4"	\$236
		INOF436-2NPF	44"	36"	2 3/4"	\$240
		INOF442-2NPF	44"	42"	2 3/4"	\$244
		INOF448-2NPF	44"	48"	2 3/4"	\$248
		INOF454-2NPF	44"	54"	2 3/4"	\$252
	INOF460-2NPF	44"	60"	2 3/4"	\$256	
	51" H Basic Frame	INOF518-2NPF	51"	18"	2 3/4"	\$246
		INOF524-2NPF	51"	24"	2 3/4"	\$249
		INOF530-2NPF	51"	30"	2 3/4"	\$254
		INOF536-2NPF	51"	36"	2 3/4"	\$259
		INOF542-2NPF	51"	42"	2 3/4"	\$268
		INOF548-2NPF	51"	48"	2 3/4"	\$278
		INOF554-2NPF	51"	54"	2 3/4"	\$282
	INOF560-2NPF	51"	60"	2 3/4"	\$289	

Product code key example

INOF642 - 2NPF



INOF	Inscape System frame
6	64" high
42	42" wide
2NPF	2 3/4" thick frame non powered

General information

- 2" deep glide cap color of black or gray (gray default)
- 24"h frame is equipped with hardware to attach to storage case
- 1 wire manager hanger included with frame
- Compatible with electrical launched after December 2010 only
- If powering a Basic frame, an Upper Deck power track kit is to be specified for all locations in the 2.75" thick frame
- Rectangular glides available for an upcharge of \$11 per frame

Notes

- **18"-24" wide frames do not come with electrical cut outs**
- **30" wide frames come with 1 electrical cutout**
- **Top caps are to be ordered separately**

Description	Part number	Height	Width	Thickness	List Price
	57" H Basic Frame				
	INOF5718-2NPF	57"	18"	2 3/4"	\$269
	INOF5724-2NPF	57"	24"	2 3/4"	\$276
	INOF5730-2NPF	57"	30"	2 3/4"	\$279
	INOF5736-2NPF	57"	36"	2 3/4"	\$290
	INOF5742-2NPF	57"	42"	2 3/4"	\$300
	INOF5748-2NPF	57"	48"	2 3/4"	\$308
	64" H Basic Frame				
	INOF618-2NPF	64"	18"	2 3/4"	\$285
	INOF624-2NPF	64"	24"	2 3/4"	\$294
	INOF630-2NPF	64"	30"	2 3/4"	\$295
	INOF636-2NPF	64"	36"	2 3/4"	\$310
	INOF642-2NPF	64"	42"	2 3/4"	\$325
	INOF648-2NPF	64"	48"	2 3/4"	\$333
INOF654-2NPF	64"	54"	2 3/4"	\$334	
INOF660-2NPF	64"	60"	2 3/4"	\$348	

System

Architecture

Frames and Screens

2 3/4" Thick Stack-on Frames

Product code key example:

INSF048-2F





INSF Inscape System Stack-on Frame
0 6.75" high
48 48" wide
2F 2 3/4" thick frame

General information

- Fully welded stack on kits easily installed and removed to adjust panel height.
- Load bearing – only one overhead unit on frame higher than 64"h only.
- Stack on frames may span multiple frames. See Application Guide for spanning guidelines.

Notes

- **Be sure to specify correct thickness of stack frame based on the frame it is being installed on**
- **May be stacked up to 91" high**

Description	Part number	Height	Width	Thickness	List Price
 6.75" H Single Stack-On	INSF018-2F	6.75"	18"	2 3/4"	\$135
	INSF024-2F	6.75"	24"	2 3/4"	\$139
	INSF030-2F	6.75"	30"	2 3/4"	\$140
	INSF036-2F	6.75"	36"	2 3/4"	\$143
	INSF042-2F	6.75"	42"	2 3/4"	\$146
	INSF048-2F	6.75"	48"	2 3/4"	\$151
	INSF054-2F	6.75"	54"	2 3/4"	\$152
	INSF060-2F	6.75"	60"	2 3/4"	\$155
 13.5" H Single Stack-On	INSF118-2F	13.5"	18"	2 3/4"	\$141
	INSF124-2F	13.5"	24"	2 3/4"	\$143
	INSF130-2F	13.5"	30"	2 3/4"	\$144
	INSF136-2F	13.5"	36"	2 3/4"	\$147
	INSF142-2F	13.5"	42"	2 3/4"	\$151
	INSF148-2F	13.5"	48"	2 3/4"	\$156
	INSF154-2F	13.5"	54"	2 3/4"	\$159
	INSF160-2F	13.5"	60"	2 3/4"	\$160
 20.25" H Single Stack-On	INSF2018-2F	20.25"	18"	2 3/4"	\$147
	INSF2024-2F	20.25"	24"	2 3/4"	\$152
	INSF2030-2F	20.25"	30"	2 3/4"	\$154
	INSF2036-2F	20.25"	36"	2 3/4"	\$159
	INSF2042-2F	20.25"	42"	2 3/4"	\$162
	INSF2048-2F	20.25"	48"	2 3/4"	\$165
	INSF2054-2F	20.25"	54"	2 3/4"	\$166
	INSF2060-2F	20.25"	60"	2 3/4"	\$168
 27" H Single Stack-On	INSF218-2F	27"	18"	2 3/4"	\$161
	INSF224-2F	27"	24"	2 3/4"	\$167
	INSF230-2F	27"	30"	2 3/4"	\$168
	INSF236-2F	27"	36"	2 3/4"	\$172
	INSF242-2F	27"	42"	2 3/4"	\$174
	INSF248-2F	27"	48"	2 3/4"	\$179
	INSF254-2F	27"	54"	2 3/4"	\$180
	INSF260-2F	27"	60"	2 3/4"	\$181

Product Code Key Example:

INSTGL24-2F

INST	Inscape System stack-on frame
GL	double glaze
24	24" wide
2F	2 3/4" thick frame

General information

- Clear and frosted acrylic options available
- Must only be installed in the top location
- Is not load bearing
- Stack on Double Glaze may span two frames. *See Application Guide for spanning guidelines
- 24" to 48" wide kits consist of welded frames
- 54" to 96" wide kits are kitted and must be assembled onsite

Notes

Be sure to specify correct thickness of stack frame based on the frame it is being installed on

In order to get a total cost on products when upcharges are present take the list price of the product number and add the upcharge cost shown to the list price.

For example:

Product INSTGL24-2F in Frosted Acrylic would be \$401 +\$71

Description	Part number	Height	Width	Thickness	Clear acrylic	Frosted acrylic	Accent paint upcharge
	13.5" H Double Glaze Stack-On Acrylic						
	INSTGL24-2F	13.5"	24"	2 3/4"	\$401	+\$71	+\$41
	INSTGL30-2F	13.5"	30"	2 3/4"	\$453	+\$79	+\$46
	INSTGL36-2F	13.5"	36"	2 3/4"	\$518	+\$89	+\$52
	INSTGL42-2F	13.5"	42"	2 3/4"	\$562	+\$98	+\$57
	INSTGL48-2F	13.5"	48"	2 3/4"	\$622	+\$108	+\$63
	INSTGL54-2F	13.5"	54"	2 3/4"	\$682	+\$106	+\$70
	INSTGL60-2F	13.5"	60"	2 3/4"	\$751	+\$117	+\$76
	INSTGL66-2F	13.5"	66"	2 3/4"	\$799	+\$138	+\$81
	INSTGL72-2F	13.5"	72"	2 3/4"	\$823	+\$141	+\$83
	INSTGL78-2F	13.5"	78"	2 3/4"	\$848	+\$145	+\$86
	INSTGL84-2F	13.5"	84"	2 3/4"	\$871	+\$148	+\$88
	INSTGL90-2F	13.5"	90"	2 3/4"	\$898	+\$154	+\$91
INSTGL96-2F	13.5"	96"	2 3/4"	\$922	+\$158	+\$93	

System

Architecture

Frames and Screens

1 1/2" Thick Segmented Screens

Product code key example

SS3718

SS	segmented screen
37	37" high
18	18" wide

General information

- Segmented screens may only be attached to the 3 1/2" thick tapered trim frames or 1 1/2" thick screens (brackets specified separately)
- These screens are not freestanding
- Screens include 2" dia glide with 1 1/2" height adjustability – optional gray (default) or black
- Segmented screens come fully trimmed
- All segments are optioned as one fabric pattern only
- Segments are tackable
- Fabric is applied in a railroad orientation
- Available with round glides only

Notes

The following fabrics are not available on segmented screens; U5005 Sprite Snow

In order to get a total cost on products when upcharges are present take the list price of the product number and add the upcharge cost shown to the list price.

For example:

Product SS3718 in Grade 5 Fabric would be \$446 +\$78

Description	Part number	Height	Width	Weight (lbs)	Grade 1/COM	Grade 2	Grade 3	Grade 4	Grade 5	Grade 6	Grade 7	Grade 8	Accent paint upcharge
	SS3718	37"	18"	9	\$446	+\$26	+\$36	—	+\$78	—	+\$257	—	+\$45
	SS3724	37"	24"	10	\$468	+\$27	+\$42	—	+\$83	—	+\$272	—	+\$48
	SS3730	37"	30"	12	\$507	+\$33	+\$51	—	+\$101	—	+\$309	—	+\$51
	SS3736	37"	36"	14	\$549	+\$42	+\$66	—	+\$120	—	+\$350	—	+\$55
	SS3742	37"	42"	15	\$588	+\$50	+\$79	—	+\$140	—	+\$390	—	+\$59
	SS3748	37"	48"	17	\$611	+\$50	+\$79	—	+\$141	—	+\$399	—	+\$62
	SS3754	37"	54"	19	\$635	+\$50	+\$79	—	+\$141	—	+\$399	—	+\$64
	SS3760	37"	60"	21	\$657	+\$50	+\$78	—	+\$144	—	+\$421	—	+\$66

37" H Segmented Screen

	SS4418	44"	18"	11	\$470	+\$29	+\$43	—	+\$88	—	+\$281	—	+\$48
	SS4424	44"	24"	12	\$496	+\$31	+\$48	—	+\$92	—	+\$296	—	+\$50
	SS4430	44"	30"	14	\$541	+\$42	+\$64	—	+\$116	—	+\$343	—	+\$55
	SS4436	44"	36"	15	\$584	+\$51	+\$79	—	+\$141	—	+\$390	—	+\$59
	SS4442	44"	42"	17	\$632	+\$62	+\$94	—	+\$162	—	+\$435	—	+\$64
	SS4448	44"	48"	19	\$656	+\$61	+\$94	—	+\$163	—	+\$444	—	+\$66
	SS4454	44"	54"	21	\$682	+\$62	+\$97	—	+\$167	—	+\$458	—	+\$70
	SS4460	44"	60"	23	\$707	+\$62	+\$96	—	+\$166	—	+\$466	—	+\$72

44" H Segmented Screen

	SS5118	51"	18"	12	\$524	+\$30	+\$51	—	+\$106	—	+\$323	—	+\$53
	SS5124	51"	24"	13	\$546	+\$38	+\$54	—	+\$109	—	+\$332	—	+\$55
	SS5130	51"	30"	15	\$599	+\$48	+\$74	—	+\$137	—	+\$388	—	+\$60
	SS5136	51"	36"	18	\$652	+\$61	+\$92	—	+\$161	—	+\$440	—	+\$66
	SS5142	51"	42"	20	\$706	+\$74	+\$111	—	+\$188	—	+\$495	—	+\$72
	SS5148	51"	48"	22	\$735	+\$74	+\$111	—	+\$188	—	+\$495	—	+\$75
	SS5154	51"	54"	24	\$765	+\$74	+\$111	—	+\$188	—	+\$495	—	+\$78
	SS5160	51"	60"	26	\$795	+\$75	+\$113	—	+\$194	—	+\$536	—	+\$81

51" H Segmented Screen

	SS6418	64"	18"	12	\$616	+\$46	+\$67	—	+\$129	—	+\$384	—	+\$62
	SS6424	64"	24"	16	\$626	+\$47	+\$74	—	+\$137	—	+\$397	—	+\$63
	SS6430	64"	30"	19	\$691	+\$65	+\$98	—	+\$171	—	+\$466	—	+\$70
	SS6436	64"	36"	21	\$757	+\$81	+\$121	—	+\$206	—	+\$535	—	+\$77
	SS6442	64"	42"	23	\$825	+\$97	+\$144	—	+\$239	—	+\$604	—	+\$84
	SS6448	64"	48"	26	\$861	+\$96	+\$145	—	+\$242	—	+\$622	—	+\$87
	SS6454	64"	54"	29	\$899	+\$96	+\$146	—	+\$244	—	+\$637	—	+\$91
	SS6460	64"	60"	32	\$935	+\$97	+\$145	—	+\$247	—	+\$653	—	+\$95

64" H Segmented Screen

Product code key example

SSG6424

SS segmented screen
G glazed
64 64" high
42 42" wide

General information

- Glazed Segmented Screens may only be attached to the 3 1/2" thick tapered trim frames or 1 1/2" thick screens (brackets specified separately)
- These screens are not freestanding
- Screens include 2" dia glide with 1 1/2" height adjustability – optional gray (default) or black
- Segmented screens come fully trimmed
- Clear acrylic is included in the top 13.5" segment
- All other segments are optioned as one fabric pattern
- Fabric segments are tackable
- Fabric is applied in a railroad orientation
- Available with round glides only

Notes

The following fabrics are not available on segmented screens; U5005 Sprite Snow

In order to get a total cost on products when upcharges are present take the list price of the product number and add the upcharge cost shown to the list price.

For example:

Product SSG6424 in Grade 5 Fabric would be \$696 +\$118. The above product upgraded to Grade 1 resin would be \$696 +\$118

Description	Part number	Height	Width	Weight (lbs)	Grade 1/COM	Grade 2	Grade 3	Grade 4	Grade 5	Grade 6	Grade 7	Grade 8	Accent paint upcharge
	SSG6424	64"	24"	16	\$696	+\$36	+\$55	—	+\$118	—	+\$398	—	+\$71
	SSG6430	64"	30"	19	\$773	+\$48	+\$75	—	+\$147	—	+\$464	—	+\$79
	SSG6436	64"	36"	21	\$848	+\$62	+\$96	—	+\$174	—	+\$527	—	+\$86
	SSG6442	64"	42"	23	\$923	+\$74	+\$113	—	+\$203	—	+\$591	—	+\$93
	SSG6448	64"	48"	26	\$1013	+\$74	+\$113	—	+\$213	—	+\$633	—	+\$102
	SSG6454	64"	54"	29	\$1101	+\$75	+\$113	—	+\$218	—	+\$670	—	+\$111
	SSG6460	64"	60"	32	\$1190	+\$75	+\$113	—	+\$218	—	+\$670	—	+\$120

64" H with Clear Acrylic

System

Architecture

Frames and Screens

1 1/2" Thick Monolithic Screens

Product code key example

MS3718

MS	monolithic screen
37	37" high
18	18" wide

General information

- Monolithic screens may only be attached to the 3 1/2" thick tapered trim frames or 1 1/2" thick screens (brackets specified separately)
- These screens are not freestanding
- Screens include 2" dia glide with 1 1/2" height adjustability – optional gray (default) or black
- Monolithic screens come fully trimmed
- Fabric screens are tackable
- Fabric is applied in a railroad orientation
- Clear and White fluted material is polycarbonate and has naturally occurring variances in the material
- Available with round glides only





Notes

The following fabrics are not available on monolithic screens; U5005 Sprite Snow

In order to get a total cost on products when upcharges are present take the list price of the product number and add the upcharge cost shown to the list price.

For example:

Product MS3718 in Grade 5 Fabric would be \$373 +\$75

Description	Part number	Height	Width	Weight (lbs)	Grade 1/COM	Grade 2	Grade 3	Grade 4	Grade 5	Grade 6	Grade 7	Grade 8	Clear fluted polycarbonate	White fluted polycarbonate	Accent paint upcharge
	MS3718	37"	18"	9	\$373	+\$26	+\$38	—	+\$75	—	+\$227	—	—	—	+\$38
	MS3724	37"	24"	10	\$402	+\$26	+\$38	—	+\$75	—	+\$237	—	+\$73	+\$73	+\$41
	MS3730	37"	30"	11	\$438	+\$32	+\$50	—	+\$91	—	+\$274	—	+\$50	+\$50	+\$45
	MS3736	37"	36"	13	\$475	+\$42	+\$65	—	+\$111	—	+\$309	—	+\$29	+\$29	+\$48
	MS3742	37"	42"	15	\$508	+\$48	+\$76	—	+\$131	—	+\$350	—	+\$24	+\$24	+\$51
	MS3748	37"	48"	16	\$529	+\$49	+\$77	—	+\$132	—	+\$358	—	+\$40	+\$40	+\$54
	MS3754	37"	54"	18	\$551	+\$51	+\$77	—	+\$134	—	+\$370	—	—	—	+\$56
	MS3760	37"	60"	19	\$573	+\$55	+\$76	—	+\$135	—	+\$378	—	—	—	+\$58
37" H Monolithic Screen															
	MS4418	44"	18"	10	\$400	+\$31	+\$45	—	+\$86	—	+\$252	—	—	—	+\$41
	MS4424	44"	24"	11	\$430	+\$34	+\$45	—	+\$96	—	+\$263	—	+\$61	+\$61	+\$44
	MS4430	44"	30"	13	\$471	+\$40	+\$59	—	+\$109	—	+\$306	—	+\$51	+\$51	+\$48
	MS4436	44"	36"	15	\$515	+\$47	+\$74	—	+\$127	—	+\$348	—	+\$43	+\$43	+\$52
	MS4442	44"	42"	16	\$553	+\$59	+\$90	—	+\$151	—	+\$394	—	+\$43	+\$43	+\$56
	MS4448	44"	48"	18	\$577	+\$61	+\$89	—	+\$152	—	+\$402	—	+\$58	+\$58	+\$58
	MS4454	44"	54"	20	\$600	+\$63	+\$88	—	+\$154	—	+\$413	—	—	—	+\$61
	MS4460	44"	60"	22	\$622	+\$65	+\$90	—	+\$156	—	+\$424	—	—	—	+\$63
44" H Monolithic Screen															
	MS5118	51"	18"	11	\$424	+\$34	+\$50	—	+\$96	—	+\$274	—	—	—	+\$43
	MS5124	51"	24"	13	\$458	+\$40	+\$52	—	+\$98	—	+\$289	—	+\$85	+\$85	+\$47
	MS5130	51"	30"	15	\$504	+\$46	+\$72	—	+\$123	—	+\$338	—	+\$78	+\$78	+\$51
	MS5136	51"	36"	17	\$552	+\$55	+\$87	—	+\$148	—	+\$390	—	+\$73	+\$73	+\$56
	MS5142	51"	42"	19	\$598	+\$70	+\$103	—	+\$173	—	+\$439	—	+\$40	+\$40	+\$60
	MS5148	51"	48"	21	\$622	+\$71	+\$104	—	+\$177	—	+\$450	—	+\$31	+\$31	+\$63
	MS5154	51"	54"	23	\$647	+\$74	+\$104	—	+\$179	—	+\$461	—	—	—	+\$65
	MS5160	51"	60"	25	\$671	+\$76	+\$104	—	+\$187	—	+\$470	—	—	—	+\$69
51" H Monolithic Screen															
	MS6418	64"	18"	11	\$448	+\$43	+\$61	—	+\$111	—	+\$302	—	—	—	+\$46
	MS6424	64"	24"	13	\$490	+\$51	+\$72	—	+\$129	—	+\$342	—	—	—	+\$50
	MS6430	64"	30"	15	\$545	+\$44	+\$67	—	+\$123	—	+\$353	—	—	—	+\$55
	MS6436	64"	36"	17	\$656	+\$29	+\$133	—	+\$214	—	+\$512	—	—	—	+\$66
	MS6442	64"	42"	19	\$686	+\$58	+\$135	—	+\$216	—	+\$524	—	—	—	+\$70
	MS6448	64"	48"	21	\$716	+\$88	+\$139	—	+\$216	—	+\$535	—	—	—	+\$73
64" H Monolithic Screen															

Product code key example

MS7118

MS monolithic screen
71 71" high
18 18" wide

General information

- Monolithic screens may only be attached to the 3 1/2" thick tapered trim frames or 1 1/2" thick screens (brackets specified separately)
- These screens are not freestanding
- Screens include 2" dia glide with 1 1/2" height adjustability – optional gray (default) or black
- Monolithic screens come fully trimmed
- Fabric screens are tackable
- Fabric is applied in a railroad orientation
- Clear and White fluted material is polycarbonate and has naturally occurring variances in the material
- Available with round glides only

Notes

The following fabrics are not available on monolithic screens; U5005 Sprite Snow

In order to get a total cost on products when upcharges are present take the list price of the product number and add the upcharge cost shown to the list price.

For example:

Product MS7118 in Grade 5 Fabric would be \$528 +\$123

Description	Part number	Height	Width	Weight (lbs)	Grade 1/COM	Grade 2	Grade 3	Grade 4	Grade 5	Grade 6	Grade 7	Grade 8	Clear fluted polycarbonate	White fluted polycarbonate	Accent paint upcharge
	MS7118	71"	18"	14	\$528	+\$47	+\$67	—	+\$123	—	+\$347	—	—	—	+\$53

71" h Monolithic Screen

System

Architecture

Frames and Screens

1 1/2" Thick Accessory Screens

Product code key example

MAS5124

MAS accessory screen
51 51" high
24 24" wide

General information

- Screens may only be attached to the 3 1/2" thick tapered trim frames or 1 1/2" thick screens (brackets specified separately)
- These screens are not freestanding
- Screens include 2" dia glide with 1 1/2" height adjustability – optional gray (default) or black
- Accessory screens come fully trimmed
- Horizontal accessories including slanted sorters, paper trays and storage compartments may be hung from accessory screen
- Fabric is applied in a railroad orientation
- Tackable
- Available with round glides only

Notes

The following fabrics are not available on accessory screens; U5005 Sprite Snow

In order to get a total cost on products when upcharges are present take the list price of the product number and add the upcharge cost shown to the list price.

For example:

Product MAS5124 in Grade 5 Fabric would be \$553 +\$101

Description	Part number	Height	Width	Weight (lbs)	Grade 1/COM	Grade 2	Grade 3	Grade 4	Grade 5	Grade 6	Grade 7	Grade 8	Accent paint upcharge
	MAS5124	51"	24"	13	\$553	+\$32	+\$50	—	+\$101	—	+\$326	—	+\$56
	MAS5130	51"	30"	14	\$608	+\$43	+\$66	—	+\$125	—	+\$377	—	+\$61
	MAS5136	51"	36"	15	\$664	+\$52	+\$84	—	+\$150	—	+\$430	—	+\$67
	MAS5142	51"	42"	15	\$717	+\$66	+\$98	—	+\$178	—	+\$485	—	+\$73
	MAS5148	51"	48"	16	\$751	+\$72	+\$100	—	+\$181	—	+\$489	—	+\$76
	MAS5154	51"	54"	17	\$785	+\$76	+\$101	—	+\$182	—	+\$513	—	+\$80
	MAS5160	51"	60"	18	\$817	+\$79	+\$102	—	+\$184	—	+\$528	—	+\$83

51" H Accessory Screen

	MAS6424	64"	24"	16	\$648	+\$44	+\$66	—	+\$126	—	+\$394	—	+\$65
	MAS6430	64"	30"	17	\$700	+\$57	+\$87	—	+\$158	—	+\$451	—	+\$71
	MAS6436	64"	36"	18	\$753	+\$72	+\$109	—	+\$187	—	+\$511	—	+\$77
	MAS6442	64"	42"	18	\$804	+\$85	+\$129	—	+\$218	—	+\$568	—	+\$82
	MAS6448	64"	48"	19	\$842	+\$89	+\$131	—	+\$223	—	+\$588	—	+\$85

64" H Accessory Screen

Product code key example

MSF5136

MSF freestanding monolithic screen
51 51" high
36 36" wide

General information

- Screens include "L" leg for freestanding support, 3/4" height adjustability
- Accessory screens come fully trimmed
- Horizontal accessories including slanted sorters, paper trays and storage compartments may be hung from accessory screen
- Max weight load of 20lbs per side
- See specifics for whiteboard maintenance and marker requirements
- Accessory screen includes tackable surface below whiteboard
- Fabric is applied in a railroad orientation
- Available with round glides only

Notes

The following fabrics are not available on accessory screens; U5005 Sprite Snow

In order to get a total cost on products when upcharges are present take the list price of the product number and add the upcharge cost shown to the list price.

For example:

Product MSF5136 in Grade 5 Fabric would be \$913 +\$192

Description	Part number	Height	Width	Weight (lbs)	Grade 1/COM	Grade 2	Grade 3	Grade 4	Grade 5	Grade 6	Grade 7	Grade 8	Accent paint upcharge
	SASF5136	51"	36"	15	\$1018	+\$30	+\$46	—	+\$127	—	+\$521	—	+\$103
	SASF5142	51"	42"	17	\$1060	+\$32	+\$48	—	+\$131	—	+\$539	—	+\$107
	SASF5148	51"	48"	19	\$1101	+\$36	+\$52	—	+\$127	—	+\$549	—	+\$111

51" H Freestanding Whiteboard Accessory Screen

	SASF6436	64"	36"	18	\$1093	+\$39	+\$45	—	+\$140	—	+\$562	—	+\$110
	SASF6442	64"	42"	20	\$1139	+\$42	+\$46	—	+\$135	—	+\$573	—	+\$115
	SASF6448	64"	48"	22	\$1191	+\$44	+\$48	—	+\$140	—	+\$574	—	+\$120

64" H Freestanding Whiteboard Accessory Screen

	MSF5136	51"	36"	23	\$913	+\$70	+\$103	—	+\$192	—	+\$575	—	+\$92
	MSF5142	51"	42"	25	\$938	+\$71	+\$104	—	+\$195	—	+\$587	—	+\$95
	MSF5148	51"	48"	27	\$964	+\$71	+\$104	—	+\$197	—	+\$598	—	+\$97

51" H Freestanding Tackable Screen

	MSF6436	64"	36"	28	\$996	+\$88	+\$134	—	+\$237	—	+\$661	—	+\$101
	MSF6442	64"	42"	31	\$1024	+\$88	+\$134	—	+\$237	—	+\$663	—	+\$103
	MSF6448	64"	48"	33	\$1054	+\$88	+\$134	—	+\$237	—	+\$667	—	+\$106

64" H Freestanding Tackable Screen

System

Architecture

Frames and Screens

1 1/2" Thick Table Mounted Screens

Product code key example

MST3736

MST table mounted screen
37 37" high
36 36" wide

General information

- May be installed on Inscape Worksurfaces
- Table mounted screens have height adjustment for above worksurface privacy and modesty
- May not be specified to attach to a 3 1/2" thick frame connector
- Fabric is applied in railed orientation
- Table mounted screen is tackable

Notes

The following fabrics are not available on accessory screens; U5005 Sprite Snow

In order to get a total cost on products when upcharges are present take the list price of the product number and add the upcharge cost shown to the list price.

For example:

Product MST3736 in Grade 7 Fabric would be \$529 +\$370

Description	Part number	Height	Width	Weight (lbs)	Grade 1/COM	Grade 2	Grade 3	Grade 4	Grade 5	Grade 6	Grade 7	Grade 8	Accent paint upcharge
	MST3736	37"	36"	13	\$529	+\$49	+\$77	—	+\$134	—	+\$370	—	+\$54
	MST3742	37"	42"	15	\$551	+\$50	+\$78	—	+\$134	—	+\$374	—	+\$56
	MST3748	37"	48"	16	\$573	+\$55	+\$79	—	+\$135	—	+\$378	—	+\$58
	MST3754	37"	54"	18	\$593	+\$57	+\$84	—	+\$138	—	+\$387	—	+\$60
	MST3760	37"	60"	19	\$614	+\$62	+\$89	—	+\$138	—	+\$396	—	+\$62

37" H Adjustable
 Framed Table
 Mounted Screen
 Tackable

Product code key example:

SWMS5118

SWMS open electrified storage frame

51 51" high

18 18" wide

General information

- This frame is an open 1 1/2" thick structure which is to be situated between Storwal units when 1 1/2" thick screens are being used to separate workstations. The open structure allows for technology to run freely through.
- 1 1/2" Storage to Screen Bracket is required to be specified.
- Available with round glides only

Description	Part number	Height	Width	Thickness	Neutral paint/ base price	Accent paint upcharge	
	1 1/2" Thick Open Electrified Storage Frame	SWMS5118	51"	18"	1.5"	\$320	+\$33
		SWMS6418	64"	18"	1.5"	\$349	+\$36
		SWMS7118	71"	18"	1.5"	\$431	+\$44

System

Architecture

Frames and Screens

Sliding Doors

Product code key example

INSD5136LH-3F

IN	Inscape System
SD	sliding door
51	51" high
36	36" wide opening
LH	Left-handed
3F	3.5" thick frame

General information

- Sliding doors consist of polycarbonate material which has naturally occurring variances in the material
- Sliding door includes complete door assembly (trim, polycarbonate material, two door pulls, two 2.5" adjustable casters and top/bottom connector brackets to attach to the panel – optional lock available)
- Black casters
- Locking option available at an upcharge of \$123 per door
- When locking door is specified the crossrail at the 37"h location must be accessible between two tiles for the locking mechanism to function
- See Application Guide for tile configuration to accommodate locking mechanism

Notes

- **Be sure to specify correct sliding door configuration based on the frame it is being installed on**
- **Sliding doors are specific to frame thickness being installed**
- **Sliding doors are handed and are based on the direction the door slides to open from front view**
- **Specify the 36"w sliding door on panel or combination of panels 42"w or greater**
- **Specify the 42"w sliding door on panel or combination of panels 48"w or greater**

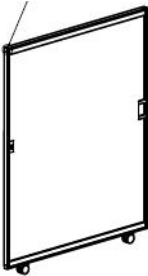
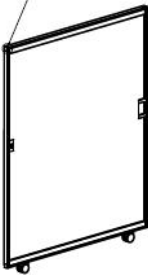
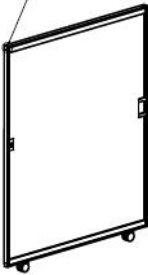
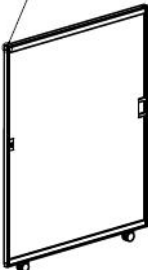
Description	Part number	Height	Width	Clear fluted polycarbonate	White fluted polycarbonate	Accent paint upcharge
 <p>51" H Sliding Door 3.5" Thick Frame</p>	INSD5136LH-3F	51"	49"	\$1119	\$1119	+\$113
	INSD5142LH-3F	51"	55"	\$1233	\$1233	+\$124
	INSD5136RH-3F	51"	49"	\$1119	\$1119	+\$113
	INSD5142RH-3F	51"	55"	\$1233	\$1233	+\$124
 <p>64" H Sliding Door 3.5" Thick Frame</p>	INSD6436LH-3F	64"	49"	\$1273	\$1273	+\$128
	INSD6442LH-3F	64"	55"	\$1456	\$1456	+\$147
	INSD6436RH-3F	64"	49"	\$1273	\$1273	+\$128
	INSD6442RH-3F	64"	55"	\$1456	\$1456	+\$147
 <p>51" H Sliding Door 2.75" Thick Frame</p>	INSD5136LH-2F	51"	49"	\$1125	\$1125	+\$113
	INSD5142LH-2F	51"	55"	\$1239	\$1239	+\$124
	INSD5136RH-2F	51"	49"	\$1125	\$1125	+\$113
	INSD5142RH-2F	51"	55"	\$1239	\$1239	+\$124
 <p>64" H Sliding Door 2.75" Thick Frame</p>	INSD6436LH-2F	64"	49"	\$1287	\$1287	+\$129
	INSD6442LH-2F	64"	55"	\$1408	\$1408	+\$142
	INSD6436RH-2F	64"	49"	\$1287	\$1287	+\$129
	INSD6442RH-2F	64"	55"	\$1408	\$1408	+\$142

General information

Inscape System 2 ½" and 3 ½" frames may be connected in a variety of ways including on and off-module, straight inline, two-way, three-way and four-way configurations. Frames of the same height or frames of differing heights may be connected together. All top caps, end of line trim, and connectors must be specified independently from the frame. To facilitate specification, connectors are available in same height kits which include all connector brackets, plugs, plates, trim clips and finished trim. 90° and 120° connections are achievable with both thickness of panel. When creating frames of varying heights, kits need to be built up. A combination of same height "L", "T" or "X" connections along with Stack-on Connectors and vertical trim will create a finished connection. Begin by connecting all common heights and working up.

A handful of universal connectors create all Inscape System panel configurations for the 2 ¾" and 3 ½" frames. The 1 ½" screen has its own set of connectors which are specific for this thinner screen. A ⅜" Allen Key is all that is required to fasten connector bolts. Trim is constructed of aluminum.

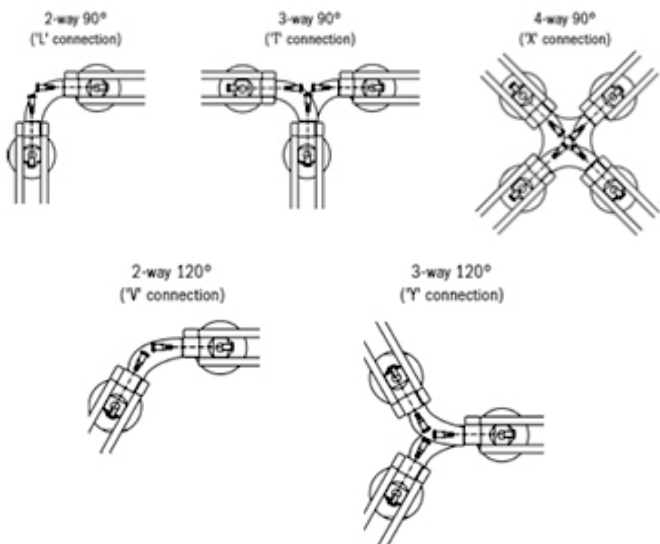

Inline connectors

Inline connectors are specified to join two frames together which are in alignment. These connectors are specified based on the height of the panels.

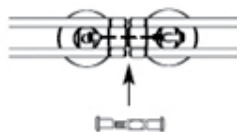

Off module connections

Off module connections are specific for frame thickness as well as location where the panel will be mounted to the spine. The off-module panel may be positioned at the end of the panel or in the middle of the panel, with the corresponding bracket. Cannot be used with monolithic tiles on spine. See Inscape System Application Guide.

Connection kits

Connection kits come in a variety of heights and configurations, within 90° and 120° connections and are based on the panel orientation. Within the connection kit, finished trim, panel connector bracket and short bolts are included depending on the configuration specified. Connector kits are panel thickness specific due to the thickness of the finished trim. The brackets and bolts within are part of the universal kit of parts and may be used for either thickness of panel. Special connectors have been structured to connect 3 ½" and 2 ¾" in the same height connections. These are also kitted and include connecting brackets and flat trim profile only. When specifying connections on module and of varying height (when only one thickness of panel is specified) the connection will need to be "built". This can be done by specifying the lowest same height connection and building stack trims to complete the top connection portion. There are a few pre-built connector kits for varying height configurations. Connector kits for Stack-on frames allow for construction of multi height connections.



Wall connectors

Wall connectors are specified based on the height of the panel attaching to the wall. All hardware is included in order to attach the panel to the wall. This connector is not visible, and sets frame off wall slightly.

End trim

End trim is kit structured to include all brackets, bolts and finished trim; Tapered or Flat. Trim profiles are available in two profile options for the 3 ½" thick frame; Tapered and Flat, and Flat for the 2 ¾" thick frames. When connecting these two thicknesses of frame at a connection, only the Flat trim profile may be specified. Vertical trim heights are available to match all frame heights as well as in four modular heights of 6.75", 13.5", 20.25" and 27". Trim is manufactured from aluminum and always aligns straight and true when frames are connected. All painted aluminum vertical trim and top trim are easily removed to facilitate lay in of cables. Veneer trim is also available for heights of 37", 51" and 64" heights.

System

Architecture

Connectors & trim

General information

Hi-Lo trim

Hi-Lo trim is designed to be situated at the end of line condition of a higher frame, where the top cap of a lower height frame meets the vertical trim. The profile of the top cap has been scribed from the Hi-Lo trim.

Stack-on end trim

Stack-on end trim is used when a higher frame requires vertical end trim at a connection. Hi-Lo trim may be used in this application for Flat profile trim because there is no 'scribing' that is required for this profile.

Top caps

Top caps are specified separately. Top caps include clips to mount on a frame or combination of two frames as outlined in the Inscape System Application Guide. Painted aluminum and veneer profile is available for both thickness of frame. Painted aluminum tapered is available for 3 1/2" thick frame. When spanning two frames when 60" or less in width, two additional Jesters are required to be specified.

1.5" Thick screen connectors

1 1/2" Thick screen connectors allow for two-way ("L"), three-way ("T"), and four way ("X") connections. Each condition, excluding the inline, includes a 1 1/2" square extruded aluminum connector post and the required number of post connector clips. The inline condition only requires inline connector clips which mount directly into the frames of the adjoining screens to complete the connection. The connector post may be finished in any of the standard Inscape System paint finishes.

Post connector clips are a standard black finish. Universal 1 1/2" connector kits include all required connector hardware and trim necessary to make 'L', 'T' and 'X' connections. Specify one height specific universal connector kit to accommodate any of the three corner conditions. Inline connector kits come complete with the required amount of connector clips.

Credenza storage benching compliment end trim

Credenza storage benching compliment end trim is specified where the low height panel is situated between two Credenza Storage cases and end trim is to be specified. This trim is available with cut out or without depending if a power feed needs to enter at that location. The trim can be painted the same color as the cases. Two end trim types have been designed; one to correspond with a lateral top and one for a cushion top. These are specific to the situation in which they are being installed. This is used for 3 1/2" thick application only. See Inscape System Application Guide.

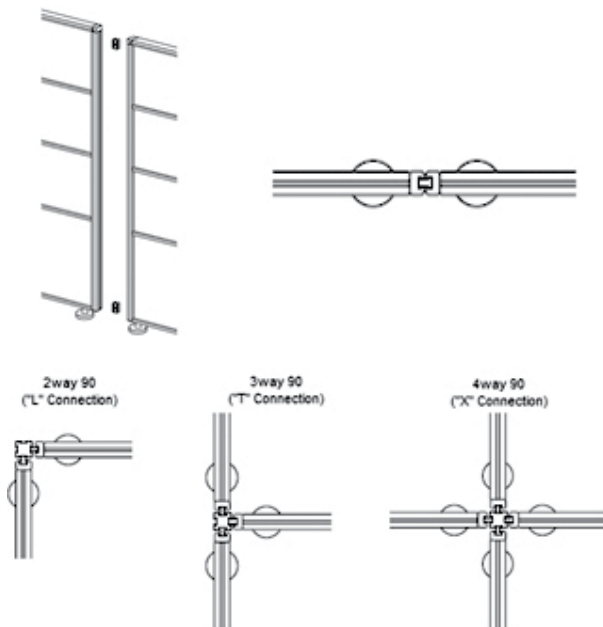

General information

- Connectors and trim are specified independently of frames
- All mounting hardware and finish trim is included for corresponding frame thickness
- Composite veneer is available in specific sizes only and is not available on the tapered trim profile

Notes

In order to get a total cost on products when upcharges are present take the list price of the product number and add the upcharge cost shown to the list price.

For example:

Product INTC18-3F Tapered in Veneer would be \$36 +\$146

Top Cap

- Top caps may span two frames. See Inscape System Application Guide for details
- Top caps up to 60"w requires two additional Jesters to be specified if spanning multiple frames (ie a 60"w top trim installed on 2-30" frames).

End Trim

- Stack-On End Trim is used when stack frames are specified and full height trim is not specified (whenever possible order full height trims when adding a stack on frame)
- Hi-Lo End trim is used where two frames in alignment are of different heights. The Hi-Lo End trim mounts to the side of the higher panel to finish it off
- Flat Hi-Lo End Trim may also be used in a stack on solution. The flat bottom profile allows for this trim to be used in multiple conditions

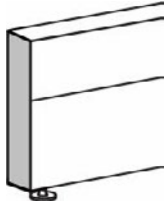
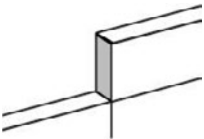
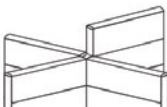
Description	Part number	Height	Thickness	Tapered	Flat	Veneer	Accent paint upcharge
 <p>Top Cap</p>	INTC18-3F	—	3 1/2"	\$36	\$36	+\$146	+\$5
	INTC24-3F	—	3 1/2"	\$43	\$43	+\$171	+\$6
	INTC30-3F	—	3 1/2"	\$51	\$51	+\$189	+\$6
	INTC36-3F	—	3 1/2"	\$56	\$56	+\$215	+\$7
	INTC42-3F	—	3 1/2"	\$61	\$61	+\$238	+\$7
	INTC48-3F	—	3 1/2"	\$63	\$63	+\$264	+\$8
	INTC54-3F	—	3 1/2"	\$78	\$78	—	+\$9
	INTC60-3F	—	3 1/2"	\$83	\$83	—	+\$10
	INTC66-3F	—	3 1/2"	—	\$97	—	+\$11
	INTC72-3F	—	3 1/2"	—	\$101	—	+\$11
	INTC78-3F	—	3 1/2"	—	\$108	—	+\$12
	INTC84-3F	—	3 1/2"	—	\$118	—	+\$13
INTC90-3F	—	3 1/2"	—	\$122	—	+\$13	
INTC96-3F	—	3 1/2"	—	\$125	—	+\$14	
 <p>End-of-Line Trim</p>	INET24-3F	24"	3 1/2"	\$29	\$29	—	+\$4
	INET29-3F	29"	3 1/2"	\$38	\$38	—	+\$5
	INET37-3F	37"	3 1/2"	\$46	\$46	+\$164	+\$6
	INET44-3F	44"	3 1/2"	\$51	\$51	—	+\$6
	INET51-3F	51"	3 1/2"	\$58	\$58	+\$214	+\$7
	INET57-3F	57"	3 1/2"	\$67	\$67	—	+\$8
	INET64-3F	64"	3 1/2"	\$75	\$75	+\$253	+\$9
	INET71-3F	71"	3 1/2"	\$86	\$86	—	+\$10
	INET78-3F	78"	3 1/2"	\$95	\$95	—	+\$11
	INET91-3F	91"	3 1/2"	\$116	\$116	—	+\$13
 <p>Hi-Lo End Trim</p>	INETHL6.75-3F	6.75"	3 1/2"	\$23	\$23	—	+\$4
	INETHL13.5-3F	13.5"	3 1/2"	\$35	\$35	+\$87	+\$5
	INETHL20.25-3F	20.25"	3 1/2"	\$43	\$43	—	+\$6
	INETHL27-3F	27"	3 1/2"	\$67	\$67	+\$115	+\$8
 <p>Stack-On Trim</p>	INET6.75-3F	6.75"	3 1/2"	\$21	\$21	—	+\$3
	INET13.5-3F	13.5"	3 1/2"	\$33	\$33	+\$89	+\$5
	INET20.25-3F	20.25"	3 1/2"	\$39	\$39	—	+\$5
	INET27-3F	27"	3 1/2"	\$63	\$63	+\$119	+\$8

System



Architecture

Connectors and Trim

3 1/2" Thick 90° Connector Kits

General information

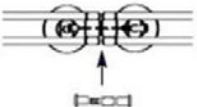
- Inline connectors are required to be specified when frames are connected inline
- Off-module bracket "MP" – when an off-module frame is to be mounted in the middle of the frame (frame thickness specific)
- Off-module bracket "EP" – when an off-module frame is to be mounted at either end of the frame. See application guide
- For back to back off-module applications at either end of a panel, 2x "EP" off-module bracket codes are required
- Two sided off-module brackets are specified when frames are off-module on both sides of the "spine" frame
- Off-module bracket suffix (3F) is based on the frame thickness
- Off-module brackets cannot be used where monolithic tiles are present on spine. The lower bracket requires segmentation in tiles to attach to crossrail
- Specify wall start connector based on the height of the frame (64" to be cut on site when used with 57"h frame)

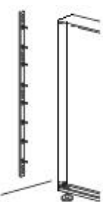
Description	Part number	Height	List Price
 <p>Inline Connector Kit</p>	INLINE-1	All Stack on Frame"	\$0
	INLINE-2	24"h - 51"h Frame"	\$0
	INLINE-3	57"h - 64"h Frame"	\$0
	INLINE-4	71"h - 91"h Frame"	\$0
 <p>Off-Module Bracket</p>	INCPOFM-MP-3F	—	\$80
	INCPOFM-EP	—	\$80
 <p>Off-Module Bracket for two sided application</p>	INCPOFMX-3F	—	\$115
 <p>Wall Start Connector</p>	INCPW2	24 & 29"	\$180
	INCPW3	37"	\$187
	INCPW4	44"	\$208
	INCPW5	51"	\$228
	INCPW6	57 & 64"	\$246
	INCPW71	71"	\$250
	INCPW7	78"	\$250
INCPW9	91"	\$254	

General information

- Connector kits include connector brackets, bolts, nuts and finished trim to create connection
- Composite veneer is available in specific sizes only and is not available on the tapered trim profile
- Specify code based on height of frames within connection
- The connection kits may be used in conjunction with Stack-on Connectors and vertical trim to create multi-height connections



Notes

Be sure to specify correct thickness of connector kit based on the frame thickness

In order to get a total cost on products when upcharges are present take the list price of the product number and add the upcharge cost shown to the list price.

For example:

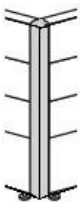
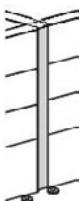
Product INCPL3300-3F in Veneer would be \$87 +\$393

Description	Part number	Height	Thickness	Tapered	Flat	Veneer	Accent paint upcharge
	Full Height Straight Filler						
	INCPSLW-3F	24"	3 1/2"	\$76	\$76	—	+\$9
	INCPS2020-3F	29"	3 1/2"	\$92	\$92	—	+\$10
	INCPS3030-3F	37"	3 1/2"	\$98	\$98	—	+\$11
	INCPS4040-3F	44"	3 1/2"	\$117	\$117	—	+\$13
	INCPS5050-3F	51"	3 1/2"	\$124	\$124	—	+\$14
	INCPS57-5050-3F	57"	3 1/2"	\$144	\$144	—	+\$16
	INCPS6060-3F	64"	3 1/2"	\$170	\$170	—	+\$18
	INCPS71-7070-3F	71"	3 1/2"	\$203	\$203	—	+\$21
INCPS7070-3F	78"	3 1/2"	\$212	\$212	—	+\$22	
INCPS9090-3F	91"	3 1/2"	\$254	\$254	—	+\$26	
	Full Height "L" Connector						
	INCPLLW-3F	24"	3 1/2"	\$62	\$62	—	+\$8
	INCPL2200-3F	29"	3 1/2"	\$80	\$80	—	+\$9
	INCPL3300-3F	37"	3 1/2"	\$87	\$87	+\$393	+\$10
	INCPL4400-3F	44"	3 1/2"	\$93	\$93	—	+\$11
	INCPL5500-3F	51"	3 1/2"	\$102	\$102	+\$429	+\$11
	INCPL57-5500-3F	57"	3 1/2"	\$113	\$113	—	+\$13
	INCPL6600-3F	64"	3 1/2"	\$133	\$133	+\$581	+\$15
	INCPL71-7700-3F	71"	3 1/2"	\$147	\$147	—	+\$16
INCPL7700-3F	78"	3 1/2"	\$156	\$156	—	+\$17	
INCPL9900-3F	91"	3 1/2"	\$187	\$187	—	+\$20	
	Full Height "T" Connector						
	INCPTLW-3F	24"	3 1/2"	\$80	\$80	—	+\$9
	INCPT2220-3F	29"	3 1/2"	\$119	\$119	—	+\$13
	INCPT3330-3F	37"	3 1/2"	\$128	\$128	+\$243	+\$14
	INCPT4440-3F	44"	3 1/2"	\$137	\$137	—	+\$15
	INCPT5550-3F	51"	3 1/2"	\$142	\$142	+\$294	+\$15
	INCPT57-5550-3F	57"	3 1/2"	\$170	\$170	—	+\$18
	INCPT6660-3F	64"	3 1/2"	\$189	\$189	+\$358	+\$20
	INCPT71-7770-3F	71"	3 1/2"	\$215	\$215	—	+\$23
INCPT7770-3F	78"	3 1/2"	\$230	\$230	—	+\$24	
INCPT9990-3F	91"	3 1/2"	\$265	\$265	—	+\$28	
	"X" Connector						
	INCPXLW-3F	24"	3 1/2"	\$113	\$113	—	+\$13
	INCPX2222-3F	29"	3 1/2"	\$154	\$154	—	+\$17
	INCPX3333-3F	37"	3 1/2"	\$165	\$165	+\$24	+\$18
	INCPX4444-3F	44"	3 1/2"	\$171	\$171	—	+\$18
	INCPX5555-3F	51"	3 1/2"	\$176	\$176	+\$26	+\$19
	INCPX57-5555-3F	57"	3 1/2"	\$190	\$190	—	+\$20
	INCPX6666-3F	64"	3 1/2"	\$203	\$203	+\$28	+\$21
	INCPX71-7777-3F	71"	3 1/2"	\$217	\$217	—	+\$23
INCPX7777-3F	78"	3 1/2"	\$224	\$224	—	+\$23	
INCPX9999-3F	91"	3 1/2"	\$250	\$250	—	+\$26	

System

Architecture

Connectors and Trim

3 1/2" Thick 90° Stack-on Connector Kits

General information

- Available in heights matching incremental change of frame heights; 6.75", 13.5", 20.25" and 27"h
- Veneer is available in specific sizes only and is not available on the tapered trim profile
- Specify based on configuration requirement
- May be used in conjunction with same height kits and end trim to create multi height configurations



Notes

Be sure to specify correct thickness of connector kit based on the frame thickness

In order to get a total cost on products when upcharges are present take the list price of the product number and add the upcharge cost shown to the list price.

For example:

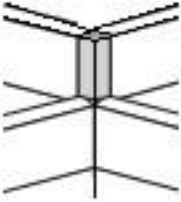
Product INCPT13.5-3F in Veneer would be \$38 +\$228

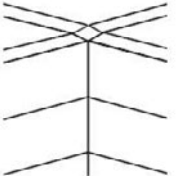
Description	Part number	Height	Thickness	Tapered	Flat	Veneer	Accent paint upcharge
 Straight Filler Connection	INCPS6.75-3F	6.75"	3 1/2"	\$27	\$27	—	+\$4
	INCPS13.5-3F	13.5"	3 1/2"	\$48	\$48	—	+\$6
	INCPS20.25-3F	20.25"	3 1/2"	\$78	\$78	—	+\$9
	INCPS27-3F	27"	3 1/2"	\$88	\$88	—	+\$10
 "L" Connection	INCPL6.75-3F	6.75"	3 1/2"	\$24	\$24	—	+\$4
	INCPL13.5-3F	13.5"	3 1/2"	\$38	\$38	+\$272	+\$5
	INCPL20.25-3F	20.25"	3 1/2"	\$60	\$60	—	+\$7
	INCPL27-3F	27"	3 1/2"	\$78	\$78	+\$348	+\$9
 "T" Connection	INCPT6.75-3F	6.75"	3 1/2"	\$24	\$24	—	+\$4
	INCPT13.5-3F	13.5"	3 1/2"	\$38	\$38	+\$228	+\$5
	INCPT20.25-3F	20.25"	3 1/2"	\$61	\$61	—	+\$7
	INCPT27-3F	27"	3 1/2"	\$78	\$78	+\$264	+\$9
 "X" Connection	INCPX6.75-3F	6.75"	3 1/2"	\$16	\$16	—	+\$3
	INCPX13.5-3F	13.5"	3 1/2"	\$21	\$21	—	+\$3
	INCPX20.25-3F	20.25"	3 1/2"	\$24	\$24	—	+\$4
	INCPX27-3F	27"	3 1/2"	\$27	\$27	—	+\$4

General information

- These configurations facilitate specification of connector kits for various multi-height panel configurations which cannot be created by stacking trim kits
- Configurations include all hardware and finished trim to create the configuration

Notes

Be sure to specify correct thickness of connector kit based on the frame thickness

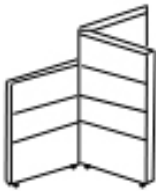
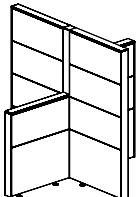
Description	Part number	Height	Thickness	Tapered	Flat	Veneer	Accent paint upcharge
	Multi Height "T" Connections						
	INCPT6560-3F	64 - 51 - 64"	3 1/2"	\$189	\$189	—	+\$20
	INCPT6460-3F	64 - 44 - 64"	3 1/2"	\$194	\$194	—	+\$21
	INCPT6360-3F	64 - 37 - 64"	3 1/2"	\$199	\$199	—	+\$21
	INCPT5450-3F	51 - 44 - 51"	3 1/2"	\$182	\$182	—	+\$19
	INCPT5350-3F	51 - 37 - 51"	3 1/2"	\$171	\$171	—	+\$18
	INCPT4340-3F	44 - 37 - 44"	3 1/2"	\$140	\$140	—	+\$15
INCPT6350-3F	64 - 37 - 51"	3 1/2"	\$182	\$182	—	+\$19	
	Multi Height "X" Connections						
	INCPX6563-3F	64 - 51 - 64 - 37"	3 1/2"	\$224	\$224	—	+\$23

System

Architecture

Connectors and Trim



3 1/2" Thick 120° Connector Kits

General information

- Connector kits include connector brackets, bolts, nuts and finished trim to create connection
- Specify code based on height of frames within connection

Notes

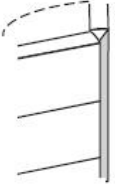
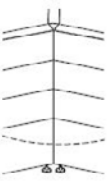
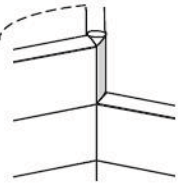
Be sure to specify correct thickness of connector kit based on the frame thickness

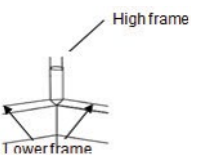
Description	Part number	Height	Thickness	Tapered	Flat	Veneer	Accent paint upcharge	
	Full Height "V" Connection	INCPV220-3F	29"	3 1/2"	\$146	\$146	—	+\$16
		INCPV330-3F	37"	3 1/2"	\$154	\$154	—	+\$17
		INCPV440-3F	44"	3 1/2"	\$163	\$163	—	+\$17
		INCPV550-3F	51"	3 1/2"	\$171	\$171	—	+\$18
		INCPV57-550-3F	57"	3 1/2"	\$182	\$182	—	+\$19
		INCPV660-3F	64"	3 1/2"	\$199	\$199	—	+\$21
	Full Height "Y" Connection	INCPY222-3F	29"	3 1/2"	\$276	\$276	—	+\$29
		INCPY333-3F	37"	3 1/2"	\$285	\$285	—	+\$29
		INCPY444-3F	44"	3 1/2"	\$298	\$298	—	+\$31
		INCPY555-3F	51"	3 1/2"	\$320	\$320	—	+\$33
		INCPY57-555-3F	57"	3 1/2"	\$386	\$386	—	+\$39
		INCPY666-3F	64"	3 1/2"	\$445	\$445	—	+\$45
	Stack-On "V" Connection	INCPV6.75-3F	6.75"	3 1/2"	\$154	\$154	—	+\$17
		INCPV13.5-3F	13.5"	3 1/2"	\$163	\$163	—	+\$17
		INCPV20.25-3F	20.25"	3 1/2"	\$171	\$171	—	+\$18
		INCPV27-3F	27"	3 1/2"	\$182	\$182	—	+\$19
	Stack-On "Y" Connection	INCPY6.75-3F	6.75"	3 1/2"	\$14	\$14	—	+\$3
		INCPY13.5-3F	13.5"	3 1/2"	\$21	\$21	—	+\$3
		INCPY20.25-3F	20.25"	3 1/2"	\$24	\$24	—	+\$4
		INCPY27-3F	27"	3 1/2"	\$27	\$27	—	+\$4
	120° Stack-On End Trim, Multi Height	INST6.75Y-3F	6.75"	3 1/2"	\$154	\$154	—	+\$17
		INST13.5Y-3F	13.5"	3 1/2"	\$163	\$163	—	+\$17
		INST20.25Y-3F	20.25"	3 1/2"	\$171	\$171	—	+\$18
		INST27Y-3F	27"	3 1/2"	\$182	\$182	—	+\$19

General information

- Connectors and trim are specified independently of frames
- All mounting hardware and finish trim is included for corresponding frame thickness
- Composite veneer is available in specific sizes only and is not available on the tapered trim profile
- 2 3/4" thickness is not available in the tapered profile

Top Cap

- Top caps may span two frames. See Inscape System Application Guide for details
- Top caps up to 60"w requires two additional Jesters to be specified if spanning multiple frames (ie a 60"w top trim installed on 2-30" frames).

End Trim

- Stack-On End Trim is used when stack frames are specified and full height trim is not specified (whenever possible order full height trims when adding a stack on frame)
- Hi-Lo End trim is used where two frames in alignment are of different heights. The Hi-Lo End trim mounts to the side of the higher panel to finish it off
- Flat Hi-Lo End Trim may also be used in a stack on solution. The flat bottom profile allows for this trim to be used in multiple conditions

Notes

In order to get a total cost on products when upcharges are present take the list price of the product number and add the upcharge cost shown to the list price.

For example:

Product INTC18-2F in Veneer would be \$36 +\$134

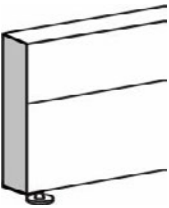
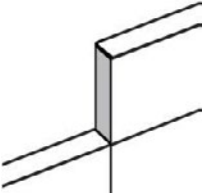
Description	Part number	Height	Thickness	Tapered	Flat	Veneer	Accent paint upcharge
 Top Cap	INTC18-2F	—	2 3/4"	—	\$36	+\$134	+\$5
	INTC24-2F	—	2 3/4"	—	\$43	+\$154	+\$6
	INTC30-2F	—	2 3/4"	—	\$51	+\$170	+\$6
	INTC36-2F	—	2 3/4"	—	\$56	+\$189	+\$7
	INTC42-2F	—	2 3/4"	—	\$61	+\$210	+\$7
	INTC48-2F	—	2 3/4"	—	\$63	+\$231	+\$8
	INTC54-2F	—	2 3/4"	—	\$78	—	+\$9
	INTC60-2F	—	2 3/4"	—	\$83	—	+\$10
	INTC66-2F	—	2 3/4"	—	\$97	—	+\$11
	INTC72-2F	—	2 3/4"	—	\$101	—	+\$11
	INTC78-2F	—	2 3/4"	—	\$108	—	+\$12
	INTC84-2F	—	2 3/4"	—	\$118	—	+\$13
	INTC90-2F	—	2 3/4"	—	\$122	—	+\$13
INTC96-2F	—	2 3/4"	—	\$125	—	+\$14	
 End-of-Line Trim	INET24-2F	24"	2 3/4"	—	\$29	—	+\$4
	INET29-2F	29"	2 3/4"	—	\$38	—	+\$5
	INET37-2F	37"	2 3/4"	—	\$46	+\$153	+\$6
	INET44-2F	44"	2 3/4"	—	\$51	—	+\$6
	INET51-2F	51"	2 3/4"	—	\$58	+\$200	+\$7
	INET57-2F	57"	2 3/4"	—	\$67	—	+\$8
	INET64-2F	64"	2 3/4"	—	\$75	+\$243	+\$9
	INET71-2F	71"	2 3/4"	—	\$86	—	+\$10
	INET78-2F	78"	2 3/4"	—	\$95	—	+\$11
	INET91-2F	91"	2 3/4"	—	\$116	—	+\$13
 Hi-Lo End Trim	INETHL6.75-2F	6.75"	2 3/4"	—	\$23	—	+\$4
	INETHL13.5-2F	13.5"	2 3/4"	—	\$35	+\$77	+\$5
	INETHL20.25-2F	20.25"	2 3/4"	—	\$43	—	+\$6
	INETHL27-2F	27"	2 3/4"	—	\$67	+\$104	+\$8

System

Architecture

Connectors and Trim

2 3/4" Thick 90° Connector Kits

General information

- Inline connectors are required to be specified when frames are connected inline
- Off-module bracket "MP" – when an off-module frame is to be mounted in the middle of the frame thickness specific)
- Off-module bracket "EP" – when an off-module frame is to be mounted at either end of the frame. See application guide
- For back to back off-module applications at either end of a panel, 2x "EP" off-module bracket codes are required
- Two sided off-module brackets are specified when frames are off-module on both sides of the "spine" frame
- Off-module bracket suffix (2F) is based on the frame thickness
- Off-module brackets cannot be used where monolithic tiles are present on spine. The lower bracket requires segmentation in tiles to attach to crossrail
- Specify wall start connector based on the height of the frame (64" to be cut on site when used with 57"h frame)

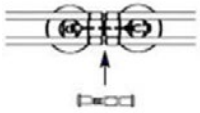
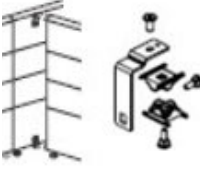
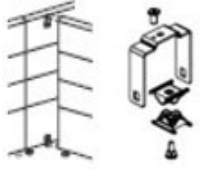
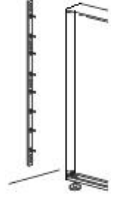
Description	Part number	Height	List Price
 <p>Inline Connector Kit</p>	INLINE-1	All Stack on Frame"	\$0
	INLINE-2	24"h - 51"h Frame"	\$0
	INLINE-3	57"h - 64"h Frame"	\$0
	INLINE-4	71"h - 91"h Frame"	\$0
 <p>Off-Module Bracket</p>	INCP OFM-MP-2F	—	\$81
	INCP OFM-EP	—	\$80
 <p>Off-Module Bracket for two sided application</p>	INCP OFMX-2F	—	\$115
 <p>Wall Start Connector</p>	INCPW2	24 & 29"	\$180
	INCPW3	37"	\$187
	INCPW4	44"	\$208
	INCPW5	51"	\$228
	INCPW6	57 & 64"	\$246
	INCPW71	71"	\$250
	INCPW7	78"	\$250
INCPW9	91"	\$254	

General information

- Configurations include all hardware and finished trim to create the configuration
- Composite veneer is available in specific sizes only
- Specify code based on height of frames within connection
- The connection kits may be used in conjunction with Stack-on Connectors and vertical trim to create multi-height connections



Notes

Be sure to specify correct thickness of connector kit based on the frame thickness

In order to get a total cost on products when upcharges are present take the list price of the product number and add the upcharge cost shown to the list price.

For example:

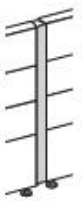
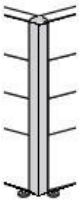
Product INCPL3300-2F in Veneer would be \$126 +\$341

Description	Part number	Height	Thickness	Tapered	Flat	Veneer	Accent paint upcharge	
	Full Height Straight Filler Connector	INCPSLW-2F	24"	2 3/4"	—	\$76	—	+\$9
		INCPS2020-2F	29"	2 3/4"	—	\$92	—	+\$10
		INCPS3030-2F	37"	2 3/4"	—	\$98	—	+\$11
		INCPS4040-2F	44"	2 3/4"	—	\$117	—	+\$13
		INCPS5050-2F	51"	2 3/4"	—	\$124	—	+\$14
		INCPS57-5050-2F	57"	2 3/4"	—	\$144	—	+\$16
	INCPS6060-2F	64"	2 3/4"	—	\$170	—	+\$18	
	Full Height "L" Connector	INCPLLW-2F	24"	2 3/4"	—	\$111	—	+\$12
		INCPL2200-2F	29"	2 3/4"	—	\$116	—	+\$13
		INCPL3300-2F	37"	2 3/4"	—	\$126	+\$341	+\$14
		INCPL4400-2F	44"	2 3/4"	—	\$135	—	+\$15
		INCPL5500-2F	51"	2 3/4"	—	\$142	+\$374	+\$15
		INCPL57-5500-2F	57"	2 3/4"	—	\$210	—	+\$22
	INCPL6600-2F	64"	2 3/4"	—	\$218	+\$478	+\$23	
	Full Height "T" Connector	INCPTLW-2F	24"	2 3/4"	—	\$80	—	+\$9
		INCPT2220-2F	29"	2 3/4"	—	\$119	—	+\$13
		INCPT3330-2F	37"	2 3/4"	—	\$128	+\$237	+\$14
		INCPT4440-2F	44"	2 3/4"	—	\$137	—	+\$15
		INCPT5550-2F	51"	2 3/4"	—	\$142	+\$286	+\$15
		INCPT57-5550-2F	57"	2 3/4"	—	\$170	—	+\$18
	INCPT6660-2F	64"	2 3/4"	—	\$189	+\$346	+\$20	
	"X" Connector	INCPXLW-2F	24"	2 3/4"	—	\$113	—	+\$13
		INCPX2222-2F	29"	2 3/4"	—	\$154	—	+\$17
		INCPX3333-2F	37"	2 3/4"	—	\$165	+\$17	+\$18
		INCPX4444-2F	44"	2 3/4"	—	\$171	—	+\$18
		INCPX5555-2F	51"	2 3/4"	—	\$176	+\$17	+\$19
		INCPX57-5555-2F	57"	2 3/4"	—	\$190	—	+\$20
	INCPX6666-2F	64"	2 3/4"	—	\$203	+\$32	+\$21	

System

Architecture

Connectors and Trim

2 3/4" Thick 90° Stack-on Connector Kits

General information

- Available in heights matching incremental change of frame heights; 6.75", 13.5", 20.25 and 27" high
- Composite veneer is available in specific sizes only
- Specify based on configuration requirement
- May be used in conjunction with same height kits and end trim to create multi height configurations



Notes

Be sure to specify correct thickness of connector kit based on the frame thickness

In order to get a total cost on products when upcharges are present take the list price of the product number and add the upcharge cost shown to the list price.

For example:

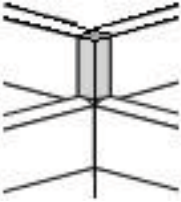
Product INCPL13.5-2F in Veneer would be \$58 +\$265

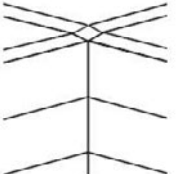
Description	Part number	Height	Thickness	Tapered	Flat	Veneer	Accent paint upcharge	
	Straight Filler Connection	INCPS6.75-2F	6.75"	2 3/4"	—	\$27	—	+\$4
		INCPS13.5-2F	13.5"	2 3/4"	—	\$48	—	+\$6
		INCPS20.25-2F	20.25"	2 3/4"	—	\$78	—	+\$9
		INCPS27-2F	27"	2 3/4"	—	\$88	—	+\$10
	"L" Connection	INCPL6.75-2F	6.75"	2 3/4"	—	\$33	—	+\$5
		INCPL13.5-2F	13.5"	2 3/4"	—	\$58	+\$265	+\$7
		INCPL20.25-2F	20.25"	2 3/4"	—	\$85	—	+\$10
		INCPL27-2F	27"	2 3/4"	—	\$111	+\$326	+\$12
	"T" Connection	INCPT6.75-2F	6.75"	2 3/4"	—	\$24	—	+\$4
		INCPT13.5-2F	13.5"	2 3/4"	—	\$38	+\$226	+\$5
		INCPT20.25-2F	20.25"	2 3/4"	—	\$61	—	+\$7
		INCPT27-2F	27"	2 3/4"	—	\$78	+\$258	+\$9
	"X" Connection	INCPX6.75-2F	6.75"	2 3/4"	—	\$16	—	+\$3
		INCPX13.5-2F	13.5"	2 3/4"	—	\$21	—	+\$3
		INCPX20.25-2F	20.25"	2 3/4"	—	\$24	—	+\$4
		INCPX27-2F	27"	2 3/4"	—	\$27	—	+\$4

General information

- These configurations facilitate specification of connector kits for various multi-height panel configurations which cannot be created by stacking trim kits
- Configurations include all hardware and finished trim to create the configuration

Notes

Be sure to specify correct thickness of connector kit based on the frame thickness

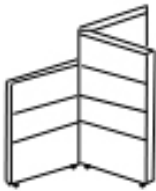
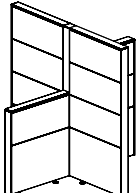
Description	Part number	Height	Thickness	Tapered	Flat	Veneer	Accent paint upcharge
	Multi Height "T" connections						
	INCPT6560-2F	64, 51, 64"	2 3/4"	—	\$189	—	+\$20
	INCPT6460-2F	64, 44, 64"	2 3/4"	—	\$194	—	+\$21
	INCPT6360-2F	64, 37, 64"	2 3/4"	—	\$199	—	+\$21
	INCPT5450-2F	51, 44, 51"	2 3/4"	—	\$182	—	+\$19
	INCPT5350-2F	51, 37, 51"	2 3/4"	—	\$171	—	+\$18
	INCPT4340-2F	44, 37, 44"	2 3/4"	—	\$140	—	+\$15
INCPT6350-2F	63, 37, 51"	2 3/4"	—	\$182	—	+\$19	
	Multi Height "X" connections						
INCPX6563-2F	64, 51, 64, 37"	2 3/4"	—	\$224	—	+\$23	

System

Architecture

Connectors and Trim



2 3/4" Thick 120° Connector Kits

General information

- Connector kits include connector brackets, bolts, nuts and finished trim to create connection
- Specify code based on height of frames within connection

Notes

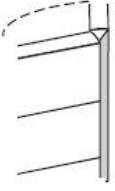

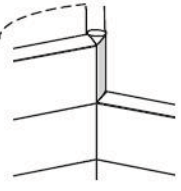
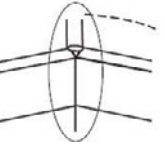
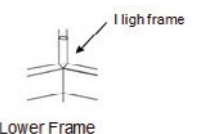
Be sure to specify correct thickness of connector kit based on the frame thickness

Description	Part number	Height	Thickness	Flat	Accent paint upcharge
	Full Height "V" Connector				
	INCPV220-2F	29"	2 3/4"	\$146	+\$16
	INCPV330-2F	37"	2 3/4"	\$154	+\$17
	INCPV440-2F	44"	2 3/4"	\$163	+\$17
	INCPV550-2F	51"	2 3/4"	\$171	+\$18
	INCPV57-550-2F	57"	2 3/4"	\$182	+\$19
	Full Height "Y" Connector				
	INCPY222-2F	29"	2 3/4"	\$276	+\$29
	INCPY333-2F	37"	2 3/4"	\$285	+\$29
	INCPY444-2F	44"	2 3/4"	\$298	+\$31
	INCPY555-2F	51"	2 3/4"	\$320	+\$33
	INCPV57-555-2F	57"	2 3/4"	\$386	+\$39
	Stack-On "V" Connector				
	INCPV6.75-2F	6.75"	2 3/4"	\$156	+\$17
	INCPV13.5-2F	13.5"	2 3/4"	\$164	+\$18
	INCPV20.25-2F	20.25"	2 3/4"	\$171	+\$18
	INCPV27-2F	27"	2 3/4"	\$182	+\$19
	INCPV10-2F	10.125"	2 3/4"	\$161	+\$17
	Stack-On "Y" Connector				
	INCPY6.75-2F	6.75"	2 3/4"	\$16	+\$3
	INCPY13.5-2F	13.5"	2 3/4"	\$21	+\$3
	INCPY20.25-2F	20.25"	2 3/4"	\$24	+\$4
	INCPY27-2F	27"	2 3/4"	\$27	+\$4
	INCPY10-2F	10.125"	2 3/4"	\$18	+\$3
	120° Stack-On End Trim, Multi Height				
	INST6.75Y-2F	6.75"	2 3/4"	\$156	+\$17
	INST13.5Y-2F	13.5"	2 3/4"	\$164	+\$18
	INST20.25Y-2F	20.25"	2 3/4"	\$171	+\$18
	INST27Y-2F	27"	2 3/4"	\$182	+\$19
	INST10Y-2F	10.125"	2 3/4"	\$161	+\$17

Screen Connectors

General information

- Inline Connectors differ from those of the Inscape System panel
- Universal connectors are self finished and solve all L, T and X connections
- Specify universal connector code based on height of the frames within connection

Description	Part number	Height	List price	Acent paint upcharge
	Inline Connectors			
	FSSC FSSC64	3 ⁷ / ₄₄ /51" 64"	\$24 \$34	— —
	Universal Connectors			
	FSUC37	37"	\$104	+\$12
	FSUC44	44"	\$112	+\$12
	FSUC51	51"	\$118	+\$13
FSUC64	64"	\$161	+\$17	
	Wall Connectors			
	CFW	—	\$40	—

System

Architecture

Connectors and Trim



1 1/2" Screen to 3 1/2" Frame Connector Kits

General information

- Configurations include all hardware and finished trim to create the configuration
- Two sided off-module brackets are specified when frames are off module on both sides of the "spine" panel
- Specify code based on height of frames within connection
- The connection kits may be used in conjunction with Stack-on Connectors and vertical trim to create multi-height connections
- 1.5" screen connectors are available for tapered trim only
- **(3F)** suffix is based on the spine panel thickness

Notes

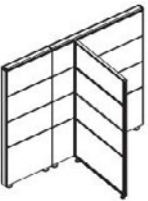
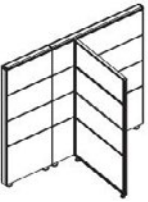
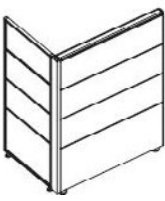
Be sure to specify correct thickness of connector kit based on the frame thickness



Description	Part number	Height	Weight	List Price	Accent paint upcharge
 <p>Off-Module (1side)</p>	INFSPOMC-3F	—	2	\$89	—
 <p>Off-Module (2side) screens must be off module at same locations on spine back to back</p>	INFSPOMBC-3F	—	2	\$134	—
 <p>"L" Connector 1 1/2" left side</p>	INFSPLC37LH-3F	37"	2	\$120	+\$13
	INFSPLC44LH-3F	44"	2	\$129	+\$14
	INFSPLC51LH-3F	51"	2	\$131	+\$14
	INFSPLC64LH-3F	64"	2	\$166	+\$18
 <p>"L" Connector 1 1/2" right side</p>	INFSPLC37RH-3F	37"	2	\$120	+\$13
	INFSPLC44RH-3F	44"	2	\$129	+\$14
	INFSPLC51RH-3F	51"	2	\$131	+\$14
	INFSPLC64RH-3F	64"	2	\$166	+\$18

General information

- Configurations include all hardware and finished trim to create the configuration
- Specify code based on height of frames within connection
- The connection kits may be used in conjunction with Stack-on Connectors and vertical trim to create multi-height connections
- 1.5" screen connectors are available for tapered trim only.
- **(3F)** suffix is based on the spine panel thickness.

Notes

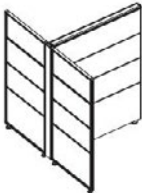
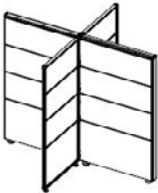
Be sure to specify correct thickness of connector kit based on the frame thickness

Description	Part number	Height	Weight	List Price	Accent paint upcharge
 <p>"T" Connector 1x3 1/2" Frame</p>	INFPSTC37-3F	37"	2	\$151	+\$16
	INFPSTC44-3F	44"	2	\$156	+\$17
	INFPSTC51-3F	51"	2	\$172	+\$18
	INFPSTC64-3F	64"	2	\$194	+\$21
 <p>"X" Connection 2x1 1/2" Screens, 2x3 1/2" Frames</p>	INFPSXC37-3F	37"	2	\$96	+\$11
	INFPSXC44-3F	44"	2	\$98	+\$11
	INFPSXC51-3F	51"	2	\$101	+\$11
	INFPSXC64-3F	64"	2	\$104	+\$12
 <p>"T" Multi Height Connector 1x1 1/2" Frame</p>	INFPSTC6560-3F	64 - 51 - 64"	2	\$206	+\$22
	INFPSTC6460-3F	64 - 44 - 64"	2	\$247	+\$26
	INFPSTC6360-3F	64 - 37 - 64"	2	\$239	+\$25
	INFPSTC5450-3F	51 - 44 - 51"	2	\$191	+\$20
	INFPSTC5350-3F	51 - 37 - 51"	2	\$186	+\$20
	INFPSTC4340-3F	44 - 37 - 44"	2	\$175	+\$19
 <p>"X" Multi Height Connector 2x1 1/2" Screens, 2x3 1/2" Frames</p>	INFPSXC6665-3F	64 - 64 - 64 - 51"	2	\$177	+\$19
	INFPSXC6664-3F	64 - 64 - 64 - 44"	2	\$183	+\$19
	INFPSXC6663-3F	64 - 64 - 64 - 37"	2	\$189	+\$20
	INFPSXC6565-3F	64 - 51 - 64 - 51"	2	\$194	+\$21
	INFPSXC6564-3F	64 - 51 - 64 - 44"	2	\$199	+\$21
	INFPSXC6563-3F	64 - 51 - 64 - 37"	2	\$240	+\$25
	INFPSXC6464-3F	64 - 44 - 64 - 44"	2	\$242	+\$25
	INFPSXC6463-3F	64 - 44 - 64 - 37"	2	\$243	+\$25
	INFPSXC6363-3F	64 - 37 - 64 - 37"	2	\$245	+\$26
	INFPSXC5554-3F	51 - 51 - 51 - 44"	2	\$158	+\$17
	INFPSXC5553-3F	51 - 51 - 51 - 37"	2	\$162	+\$17
	INFPSXC5454-3F	51 - 44 - 51 - 44"	2	\$178	+\$19
	INFPSXC5453-3F	51 - 44 - 51 - 37"	2	\$183	+\$19
	INFPSXC5353-3F	51 - 37 - 51 - 37"	2	\$186	+\$20
INFPSXC4443-3F	44 - 44 - 44 - 37"	2	\$158	+\$17	
INFPSXC4343-3F	44 - 37 - 44 - 37"	2	\$182	+\$19	

System

Architecture

Connectors and Trim

2 3/4" Frame to 3 1/2" Frame Same Height Connector Kits

General information

- Configurations include all hardware and finished trim to create the configuration
- Specify code based on height of frames within connection
- The connection kits may be used in conjunction with Stack-on Connectors and vertical trim to create multi-height connections
- **(3F)** suffix is based on the spine panel thickness

Notes

- **Number in diagrams depict panel thickness**
- **Lefts and rights are determined from the inside view of the connection**

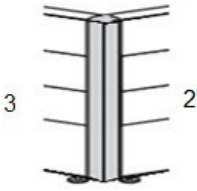
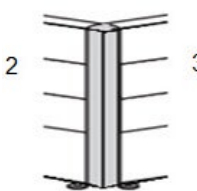
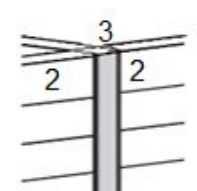
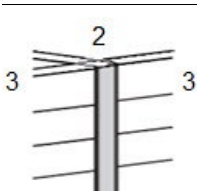
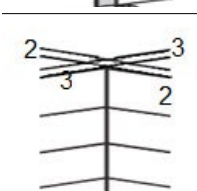
Description	Part number	Height	Thickness	List price	Accent paint upcharge	
	"L" Connector 2 3/4" to 3 1/2" Frames	INCPL24-3R2L	24"	2 3/4"	\$130	+\$14
	INCPL29-3R2L	29"	2 3/4"	\$143	+\$15	
	INCPL37-3R2L	37"	2 3/4"	\$154	+\$17	
	INCPL44-3R2L	44"	2 3/4"	\$168	+\$18	
	INCPL51-3R2L	51"	2 3/4"	\$177	+\$19	
	INCPL57-3R2L	57"	2 3/4"	\$186	+\$20	
INCPL64-3R2L	64"	2 3/4"	\$249	+\$26		
	"L" Connector 3 1/2" to 2 3/4" Frames	INCPL24-2R3L	24"	2 3/4"	\$130	+\$14
	INCPL29-2R3L	29"	2 3/4"	\$143	+\$15	
	INCPL37-2R3L	37"	2 3/4"	\$154	+\$17	
	INCPL44-2R3L	44"	2 3/4"	\$168	+\$18	
	INCPL51-2R3L	51"	2 3/4"	\$177	+\$19	
	INCPL57-2R3L	57"	2 3/4"	\$186	+\$20	
INCPL64-2R3L	64"	2 3/4"	\$249	+\$26		
	"T" Connector 1x3 1/2" Frame, 2x2 3/4" Frames	INCPT24-223	24"	2 3/4"	\$159	+\$17
	INCPT29-223	29"	2 3/4"	\$163	+\$17	
	INCPT37-223	37"	2 3/4"	\$168	+\$18	
	INCPT44-223	44"	2 3/4"	\$174	+\$19	
	INCPT51-223	51"	2 3/4"	\$179	+\$19	
	INCPT57-223	57"	2 3/4"	\$183	+\$19	
INCPT64-223	64"	2 3/4"	\$251	+\$26		
	"T" Connector 2x3 1/2" Frame, 1x2 3/4" Frames	INMHC24-332	24"	2 3/4"	\$147	+\$16
	INMHC29-332	29"	2 3/4"	\$149	+\$16	
	INMHC37-332	37"	2 3/4"	\$155	+\$17	
	INMHC44-332	44"	2 3/4"	\$161	+\$17	
	INMHC51-332	51"	2 3/4"	\$165	+\$18	
	INMHC57-332	57"	2 3/4"	\$170	+\$18	
INMHC64-332	64"	2 3/4"	\$251	+\$26		
	"X" Connector 2x3 1/2" Frames, 2x2 3/4" Frames	INCPX24-3322	24"	2 3/4"	\$108	+\$12
	INCPX29-3322	29"	2 3/4"	\$109	+\$12	
	INCPX37-3322	37"	2 3/4"	\$113	+\$13	
	INCPX44-3322	44"	2 3/4"	\$113	+\$13	
	INCPX51-3322	51"	2 3/4"	\$113	+\$13	
	INCPX57-3322	57"	2 3/4"	\$117	+\$13	
INCPX64-3322	64"	2 3/4"	\$164	+\$18		

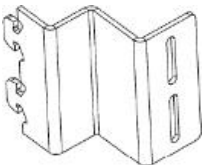
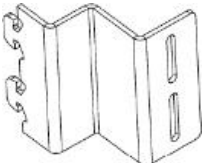
Description	Part number	Thickness	List price
 <p>3 1/2" Frame to ADDWALL Connection Bracket Straight Intersection</p>	INSCBSIA-3F	3 1/2"	\$52
 <p>2 3/4" Frame to ADDWALL Connection Bracket Straight Intersection</p>	INSCBSIA-2F	2 3/4"	\$52

System





Architecture

Connectors and Trim

Planna Storage Benching End Trim



General information

- Includes mounting hardware to attach to the adjacent storage cases
- 3 ½" thick version only
- Specific for worksurface or cushion above storage
- Specify whether a cut out is required to allow electrical feed and data cabling to enter frame behind

Description	Part number	Height	Width	Weight (lbs)	List price	Accent paint upcharge
 <p>End Trim with Electrical Cutout, Worksurface compatible (worksurface above)</p>	PLNCETCO	25"	3.5"	2	\$78	+\$9
 <p>End Trim without Cutout / Private Office Case Back Filler, Worksurface compatible (worksurface above)</p>	PLNCET	25"	3.5"	2	\$75	+\$9
 <p>End Trim with Electrical Cutout, Cushion compatible (cushion above)</p>	PLNCETCOCUSH	25"	3.5"	2	\$63	+\$8
 <p>End Trim without Cutout / Private Office Case Back Filler, Cushion compatible (cushion above)</p>	PLNCETCUSH	25"	3.5"	2	\$59	+\$7

General information

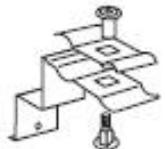
- Filler inserts omit small gap between the Storwal case and the frame where they join
- Must be specified with Storwal Connection Bracket (3 1/2" and 2 3/4" thick frames)
- Storwal Connecting Bracket connects the frame to the Storwal unit

Description	Part number	Height	List Price	Accent paint upcharge
 <p>Storwal to 1 1/2" Screen Connecting Bracket</p>	SWFFBKT	—	\$19	+\$3
 <p>Storwal Connecting Bracket for use with both frame thicknesses</p>	INSCBKT	—	\$79	—
 <p>Filler Insert (Pair) for use with both frame thicknesses</p>	INFIL51	51"	\$65	+\$8
	INFIL64	64"	\$72	+\$8
	INFIL71	71"	\$78	+\$9

General information

Tiles are available as fabric, painted, tackable, veneer, Nuform, Double Glazed and whiteboard. Tiles are interchangeable between 2.75" and 3.5" frame thickness (the thickness of the frame is determined by the tile clips which come with the frame). Tile heights vary and must always align with a crossrail on the frame as this is where the tile clips are located. If alternative tile configurations are required, additional crossrails may be specified separately and installed in the field (crossrails will include tile clips depending on thickness opted for). Tiles may be positioned in any location unless otherwise stated or crossrail does not permit.

Tiles are held in place by tile clips. These clips snap between panel crossrails and may easily be removed and/or replaced if necessary when changing the thickness of the panel. Clips support panel tiles and top trim. The clips are made of Delrin which is a resin similar to nylon in strength but has more rigidity and superior memory. These characteristics allow the Inscape System clips to retain their original shape without permanently deforming under continual pressure. This ensures tiles and trim will snap into place with a solid "click" time after time.

Fabric and painted tiles

Fabric and painted tiles are available 27", 20.25" and 6.75" high, as well as 13.5" and are constructed from 24 gauge galvanized steel. Powder-coated and fabric-covered steel tiles have a flame spread rating of less than 200 when tested according to ASTM-E84. Fabric-covered tiles are available in standard fabrics or COM. COM fabrics are subject to approval. White or extremely light colored COM fabrics will incur an upcharge of 25% to the tile pricing with which the fabric is being applied. This is due to special handling of the fabric and tiles, in addition to painting of the tiles. Painted tiles are available in the colors shown in our Color Guide and are available in the following styles: plain steel, perforated, and steel screen. Fabric on tiles is applied in a railroad orientation.

Tackable tiles

Tackable tiles are constructed from 24 gauge cold rolled steel with a paint finish on all surfaces to prevent corrosion. The same general rules from the fabric tile section apply to the Tackable tiles. Fabric on tiles is applied in a railroad orientation. NRC 0.57, STC 9. **Tackable Acoustical tiles are available through Standard Specials with NRC of .73 and an STC of 12.**

Nuform Tiles consist of gray melamine-backed MDF substrate 0.375" thick, with vacuum-formed Nuform foil over the front's surface and sides. The back-side of the tile also has routing features that accept zinc die-cast tile clips. All Nuform tiles incorporate a stiffener on the rear of the tile to ensure straightness and rigidity. This stiffener limits where the tile may be placed on a 2.75" thick frame. Nuform tiles cannot be specified in a location where a power track is installed due to interference. A sticker on the back of Nuform tiles provides UL flame / smoke-rating information. Woodgrain pattern is vertical. Due to limitations in the foil size, 48" and wider tiles are not available in F06 Walnut.

Composite veneer tiles

Composite veneer tiles are constructed utilizing 45 lbs. density particle board with an engineered balanced backer for structural integrity. Veneer thickness is 0.025". The backside of the tile has routing features that accept zinc die-cast tile clips. All Composite Veneer Tiles incorporate a stiffener on the rear of the tile to ensure straightness and rigidity. This stiffener bar limits where the tile may be placed (See Inscape System Application Guide for details). Composite Veneer tiles cannot be specified in a location where a power track is installed due to interference on a 2.75" thick frame. Woodgrain pattern is vertical.

Whiteboard tiles

Whiteboard tiles are available in two heights, 13.5" and 20.25". Tiles are constructed from 24 gauge cold rolled steel with optional white, gray or black paint finishes that has been specifically formulated for dry erase markers. Whiteboards are seamless and fit same locations as standard painted tiles.

Note: Inscape whiteboards are specifically designed for use with DRY-ERASE markers only. WHITEBOARDS ARE NOT INTENDED FOR USE WITH PERMANENT MARKERS. Inscape advises the use of Sanford Expo Dry Erase markers with whiteboards. For a thorough cleaning, use Sanford Expo spray cleaner.

Paper management tiles

Paper management tiles support horizontal paper management accessories. Organizers may be positioned at any point along the width of the tile. Three slats structured into the tile allow for three different height options for the accessories to be installed. Accessories may be found under Horizontal Accessories under the "Storage and Accessories" section. Maximum load capacity is 75lbs. When specifying paper management tiles which will be supporting a monitor arm, a Paper Management Reinforcing kit is required for additional structure. The 54" and 60" w tiles are pre-structured with these kits.

Perforated tiles

Perforated tiles are constructed of 24 gauge galvanized steel, the Steel Screen tiles are constructed from 24 gauge cold rolled steel. Tiles may be painted in any of Inscape's standard colors or color matches.

Communication tiles

Communication tiles provide power OR data access. The 24" and 30" wide include one cut out while all wider tile widths include two cut outs. Tiles provide electrical access in frames 30" w and wider only and data access in all panel widths. Bezels in tile may be specified in black, white (close match to P168 – Glacier White) and gray (close match to P326 – Moonlight) as well with the data or electrical components. Bezels are flush with tile, NOT recessed.

Fabric/finishes & worksurface general notes

Fabric patterns which are available in 54" and 55" both have limitations on the sizes of tiles available. Tile sizes longer than 42" are not available.

Codes with the following suffix have specific install locations

UD	Upper Deck
BL	Beltline
BS	Base

Multi access tiles

Multi access tiles provide electrical AND data access. Cut outs align with power track and proper tiles must be specified in specific areas if stated. Data and Electrical components may be specified from the Technology section. Bezels in tile may be specified in black, white (close match to P168 – Glacier White) and gray (close match to P326 – Moonlight) as well with the data or electrical components. Bezels are flush with tile, NOT recessed.

Codes with the following suffix have specific install locations

UD	Upper Deck
BL	Beltline
BS	Base

Monolithic tiles

Monolithic tiles are specified based on the height and width of the frame with which they are being installed. Monolithic tiles are available in painted or fabric (fabric wrapped steel).

Monolithic tiles with multi access

Monolithic tiles with multi access provide electrical and data cut outs at the bottom of the frame (same as Multi Access tile). Cut outs align with power track and proper tiles must be specified in specific areas if stated. Data and Electrical components may be specified from the Technology section. Bezels in tile may be specified in black, white (close match to P168 – Glacier White) and gray (close match to P326 – Moonlight) as well as with the data or electrical components.

Double glazed tiles

Double glazed tiles are available in 13.5" high and may be installed on frames 24" to 48" wide in place of a tile. Double Glazed tiles feature a double pane of frosted acrylic or clear acrylic framed by vertical and

horizontal trim. Double Glazed tiles may be installed one on top of another. If wider than 60" of glaze is desired; Stack on Double Glazed Kits may be specified.

The credenza storage multi access tile

The credenza storage multi access tile is required for termination of electrical and data at points behind the Credenza Storage case. The multi access tile can be optioned in any standard paint color. The multi access tile designed for Credenza Storage includes proper hardware to mount the tile to the Credenza Storage benching frame. Be sure to specify electrical components such as the Upper Deck electrical kit, duplexes and phone/data components separately. This tile is only structured in conjunction with the 3.5" thickness.

Tile height & type		Tile width													
		18"	24"	30"	36"	42"	48"	54"	60"	66"	72"	78"	84"	90"	96"
6.75"h	Painted														
13.5"h	Painted														
20.25"h	Painted														
27"h	Painted														
37"h	Monolithic painted														
44"h	Monolithic painted														
51"h	Monolithic painted														
57"h	Monolithic painted														
64"h	Monolithic painted														
6.75"h	Fabric														
13.5"h	Fabric														
20.25"h	Fabric														
27"h	Fabric														
37"h	Monolithic fabric														
44"h	Monolithic fabric														
51"h	Monolithic fabric														
57"h	Monolithic fabric														
64"h	Monolithic fabric														
13.5"h	Tackable														
20.25"h	Tackable														
27"h	Tackable														
6.75"h	Nuform/Woodgrain														
13.5"h	Nuform/Woodgrain														
20.25"h	Nuform/Woodgrain														
27"h	Nuform/Woodgrain														
13.5"h	Whiteboard														
20.25"h	Whiteboard														
6.75"h	Paper management														
13.5"h	Double glazed														
6.75"h	Comm - UD - fabric/painted														
13.5"h	Comm - UD - fabric/painted														
20.25"h	Comm - BS - fabric/painted														
6.75"h	Comm - BL - fabric/painted														
13.5"h	Comm - BL - fabric/painted														
37"h	Monolithic - comm painted														
44"h	Monolithic - comm painted														
51"h	Monolithic - comm painted														
57"h	Monolithic - comm painted														
64"h	Monolithic - comm painted														
6.75"h	Planna m/a - UD -fabric/painted														
6.75"h	M/A - UD - fabric/painted														
13.5"h	M/A - UD - fabric/painted														
20.25"h	M/A - BS - fabric/painted														
6.75"h	M/A - BL - fabric/painted														
13.5"h	M/A - BL - fabric/painted														
37"h	Monolithic - comm fabric														
44"h	Monolithic - comm fabric														
51"h	Monolithic - comm fabric														
57'h	Monolithic - comm fabric														
64"h	Monolithic - comm fabric														

System

Architecture

Tiles
Painted



Product code key example:

IN6.75P18

IN Inscape System
6.75 6.75" high
P painted
18 18" wide

General information

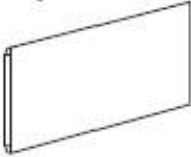
- Painted tiles are available in any of Inscape's standard paint colours or a custom colour can be accommodated
- Painted tile is magnetic
- Be sure to confirm crossrail locations will accommodate tile height
- Crossrails can be found in the accessory section of the price list under Panel and Table accessories
- Tiles 66"W or wider span two frames. See Application Guide for frame spanning guidelines

Description	Part number	Height	Width	Neutral paint, base price	Accent paint upcharge
 6.75" H Painted Tile	IN6.75P18	6.75"	18"	\$49	+\$6
	IN6.75P24	6.75"	24"	\$54	+\$7
	IN6.75P30	6.75"	30"	\$59	+\$7
	IN6.75P36	6.75"	36"	\$61	+\$7
	IN6.75P42	6.75"	42"	\$62	+\$8
	IN6.75P48	6.75"	48"	\$65	+\$8
	IN6.75P54	6.75"	54"	\$67	+\$8
 13.5" H Painted Tile	IN13.5P18	13.5"	18"	\$50	+\$6
	IN13.5P24	13.5"	24"	\$56	+\$7
	IN13.5P30	13.5"	30"	\$61	+\$7
	IN13.5P36	13.5"	36"	\$62	+\$8
	IN13.5P42	13.5"	42"	\$64	+\$8
	IN13.5P48	13.5"	48"	\$66	+\$8
	IN13.5P54	13.5"	54"	\$69	+\$8
	IN13.5P60	13.5"	60"	\$73	+\$9
	IN13.5P66	13.5"	66"	\$154	+\$17
	IN13.5P72	13.5"	72"	\$160	+\$17
	IN13.5P78	13.5"	78"	\$163	+\$17
 20.25" H Painted Tile	IN20.25P18	20.25"	18"	\$66	+\$8
	IN20.25P24	20.25"	24"	\$69	+\$8
	IN20.25P30	20.25"	30"	\$73	+\$9
	IN20.25P36	20.25"	36"	\$77	+\$9
	IN20.25P42	20.25"	42"	\$79	+\$9
	IN20.25P48	20.25"	48"	\$81	+\$9
	IN20.25P54	20.25"	54"	\$85	+\$10
	IN20.25P60	20.25"	60"	\$88	+\$10
	IN20.25P66	20.25"	66"	\$180	+\$19
	IN20.25P72	20.25"	72"	\$185	+\$20
	IN20.25P78	20.25"	78"	\$190	+\$20
 27" H Painted Tile	IN27P18	27"	18"	\$79	+\$9
	IN27P24	27"	24"	\$81	+\$9
	IN27P30	27"	30"	\$83	+\$10
	IN27P36	27"	36"	\$97	+\$11
	IN27P42	27"	42"	\$104	+\$12
	IN27P48	27"	48"	\$118	+\$13

Product code key example:
IN6.75F18

IN Inscape System
6.75 6.75" high
F fabric
18 18" wide

General information

- Fabric applied in a railroad orientation as standard
- Fabric tile is magnetic
- Be sure to confirm crossrail locations will accommodate tile height
- Crossrails can be found in the accessory section of the price list under Panel and Table accessories
- Tiles 66"W or wider span two frames. See Application Guide for frame spanning guidelines





Notes

See finishes section for fabrics that require scrim

Tile size limitations exist for some fabrics, see finishes section

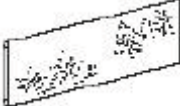
In order to get a total cost on products when upcharges are present take the list price of the product number and add the upcharge cost shown to the list price.

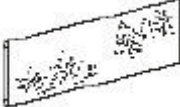
**For example:
Product IN6.75F18 in Grade 2 with scrim would be \$73 +\$4 +\$11**

Description	Part number	Width	Grade 1/COM	Grade 2	Grade 3	Grade 4	Grade 5	Grade 6	Grade 7	Grade 8	Scrim
 6.75" H Fabric Tile	IN6.75F18	18"	\$73	+\$4	+\$7	+\$11	+\$14	+\$27	+\$40	+\$56	+\$11
	IN6.75F24	24"	\$76	+\$5	+\$8	+\$13	+\$17	+\$31	+\$45	+\$63	+\$11
	IN6.75F30	30"	\$78	+\$6	+\$9	+\$13	+\$17	+\$32	+\$46	+\$65	+\$11
	IN6.75F36	36"	\$80	+\$6	+\$9	+\$18	+\$26	+\$44	+\$63	+\$88	+\$12
	IN6.75F42	42"	\$82	+\$7	+\$12	+\$20	+\$27	+\$46	+\$66	+\$92	+\$12
	IN6.75F48	48"	\$84	+\$7	+\$12	+\$20	+\$27	+\$46	+\$66	+\$92	+\$12
	IN6.75F54	54"	\$85	+\$8	+\$16	+\$22	+\$28	+\$49	+\$71	+\$98	+\$12
	IN6.75F60	60"	\$88	+\$9	+\$17	+\$24	+\$30	+\$51	+\$74	+\$102	+\$13
 13.5" H Fabric Tile	IN13.5F18	18"	\$84	+\$4	+\$18	+\$20	+\$26	+\$38	+\$52	+\$74	+\$12
	IN13.5F24	24"	\$87	+\$4	+\$20	+\$23	+\$29	+\$37	+\$51	+\$73	+\$12
	IN13.5F30	30"	\$91	+\$5	+\$22	+\$28	+\$32	+\$37	+\$52	+\$74	+\$13
	IN13.5F36	36"	\$95	+\$9	+\$22	+\$30	+\$37	+\$58	+\$79	+\$110	+\$13
	IN13.5F42	42"	\$100	+\$11	+\$23	+\$31	+\$39	+\$62	+\$84	+\$117	+\$14
	IN13.5F48	48"	\$103	+\$11	+\$23	+\$31	+\$39	+\$62	+\$85	+\$118	+\$14
	IN13.5F54	54"	\$106	+\$12	+\$24	+\$34	+\$44	+\$69	+\$92	+\$128	+\$16
	IN13.5F60	60"	\$111	+\$12	+\$24	+\$34	+\$44	+\$69	+\$92	+\$128	+\$16
	IN13.5F66	66"	\$207	+\$13	+\$24	+\$34	+\$44	+\$70	+\$93	+\$130	+\$80
	IN13.5F72	72"	\$211	+\$13	+\$14	+\$21	+\$28	+\$57	+\$85	+\$118	+\$81
	IN13.5F78	78"	\$212	+\$13	+\$16	+\$23	+\$30	+\$61	+\$91	+\$127	+\$81
	IN13.5F84	84"	\$222	+\$14	+\$16	+\$23	+\$30	+\$61	+\$91	+\$127	+\$82
	IN13.5F90	90"	\$223	+\$14	+\$17	+\$26	+\$34	+\$66	+\$97	+\$135	+\$101
	IN13.5F96	96"	\$225	+\$15	+\$18	+\$28	+\$37	+\$71	+\$102	+\$143	+\$101
 20.25" H Fabric Tile	IN20.25F18	18"	\$100	+\$4	+\$10	+\$19	+\$28	+\$46	+\$65	+\$91	+\$23
	IN20.25F24	24"	\$109	+\$5	+\$16	+\$24	+\$32	+\$52	+\$73	+\$101	+\$23
	IN20.25F30	30"	\$115	+\$5	+\$17	+\$25	+\$33	+\$54	+\$75	+\$103	+\$24
	IN20.25F36	36"	\$121	+\$6	+\$18	+\$28	+\$37	+\$61	+\$85	+\$118	+\$25
	IN20.25F42	42"	\$128	+\$6	+\$12	+\$25	+\$37	+\$62	+\$87	+\$121	+\$26
	IN20.25F48	48"	\$134	+\$8	+\$24	+\$34	+\$44	+\$73	+\$99	+\$139	+\$26
	IN20.25F54	54"	\$138	+\$8	+\$26	+\$38	+\$50	+\$81	+\$110	+\$153	+\$27
	IN20.25F60	60"	\$147	+\$10	+\$36	+\$49	+\$63	+\$94	+\$125	+\$175	+\$28
	IN20.25F66	66"	\$255	+\$10	+\$36	+\$50	+\$64	+\$95	+\$126	+\$176	+\$83
	IN20.25F72	72"	\$258	+\$10	+\$36	+\$50	+\$64	+\$95	+\$126	+\$176	+\$84
	IN20.25F78	78"	\$264	+\$23	+\$28	+\$40	+\$51	+\$93	+\$134	+\$188	+\$84
	IN20.25F84	84"	\$277	+\$25	+\$29	+\$42	+\$56	+\$98	+\$141	+\$196	+\$104
	IN20.25F90	90"	\$280	+\$26	+\$32	+\$46	+\$60	+\$104	+\$149	+\$208	+\$104
	IN20.25F96	96"	\$283	+\$27	+\$33	+\$49	+\$65	+\$112	+\$158	+\$220	+\$106
 27" H Fabric Tile	IN27F18	18"	\$116	+\$4	+\$11	+\$21	+\$30	+\$54	+\$77	+\$107	+\$23
	IN27F24	24"	\$120	+\$5	+\$11	+\$22	+\$33	+\$58	+\$83	+\$116	+\$24
	IN27F30	30"	\$128	+\$6	+\$12	+\$24	+\$36	+\$63	+\$90	+\$125	+\$25
	IN27F36	36"	\$135	+\$7	+\$18	+\$30	+\$41	+\$73	+\$102	+\$143	+\$26
	IN27F42	42"	\$148	+\$8	+\$20	+\$32	+\$43	+\$75	+\$107	+\$148	+\$27
	IN27F48	48"	\$151	+\$9	+\$22	+\$34	+\$46	+\$81	+\$115	+\$161	+\$28

System

Architecture

Tiles

Tackable

Product code key example:

IN13.5TK18

IN Inscape System
13.5 13.5" high
TK tackable
18 18" wide

General information

- Fabric applied in a railroad orientation as standard
- Fabric tile is magnetic
- NRC 0.55, STC 9
- Wall Mount Tile Kit must match height of tile
- It is recommended that tackable tiles are not to be used on the outside of a workstation
- Be sure to confirm crossrail locations will accommodate tile height
- Crossrails can be found in the accessory section of the price list under Panel and Table accessories

Notes



See finishes section for fabrics that require scrim

Tile size limitations exist for some fabrics, see finishes section

In order to get a total cost on products when upcharges are present take the list price of the product number and add the upcharge cost shown to the list price

For example:

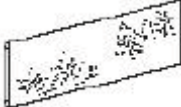
Product IN13.5TK18 in Grade 2 with scrim would be \$126 +\$4 +\$21

Description	Part number	Width	Grade 1/COM	Grade 2	Grade 3	Grade 4	Grade 5	Grade 6	Grade 7	Grade 8	Scrim
 13.5" H Tackable Tile	IN13.5TK18	18"	\$126	+\$4	+\$8	+\$16	+\$24	+\$43	+\$63	+\$88	+\$21
	IN13.5TK24	24"	\$130	+\$5	+\$9	+\$17	+\$24	+\$44	+\$64	+\$89	+\$23
	IN13.5TK30	30"	\$134	+\$6	+\$9	+\$17	+\$24	+\$45	+\$66	+\$92	+\$24
	IN13.5TK36	36"	\$138	+\$9	+\$18	+\$27	+\$36	+\$63	+\$89	+\$124	+\$25
	IN13.5TK42	42"	\$142	+\$10	+\$19	+\$28	+\$37	+\$65	+\$92	+\$128	+\$27
	IN13.5TK48	48"	\$162	+\$10	+\$19	+\$30	+\$40	+\$71	+\$99	+\$139	+\$28
 20.25" H Tackable Tile	IN20.25TK18	18"	\$188	+\$3	+\$10	+\$18	+\$26	+\$47	+\$70	+\$96	+\$23
	IN20.25TK24	24"	\$191	+\$5	+\$11	+\$21	+\$31	+\$55	+\$79	+\$110	+\$25
	IN20.25TK30	30"	\$194	+\$6	+\$11	+\$22	+\$33	+\$65	+\$97	+\$135	+\$27
	IN20.25TK36	36"	\$198	+\$7	+\$18	+\$28	+\$38	+\$69	+\$98	+\$138	+\$29
	IN20.25TK42	42"	\$201	+\$7	+\$12	+\$23	+\$33	+\$63	+\$92	+\$128	+\$31
	IN20.25TK48	48"	\$206	+\$9	+\$18	+\$31	+\$43	+\$75	+\$104	+\$146	+\$33
 33.75" H Tackable Tile	IN33.75TK18	18"	\$282	+\$11	+\$18	+\$25	+\$32	+\$63	+\$94	+\$131	+\$27
	IN33.75TK24	24"	\$297	+\$12	+\$18	+\$25	+\$32	+\$65	+\$97	+\$135	+\$30
	IN33.75TK30	30"	\$313	+\$12	+\$22	+\$26	+\$33	+\$67	+\$101	+\$142	+\$34
	IN33.75TK36	36"	\$330	+\$25	+\$29	+\$43	+\$57	+\$102	+\$147	+\$205	+\$37
	IN33.75TK42	42"	\$347	+\$25	+\$30	+\$43	+\$57	+\$104	+\$151	+\$212	+\$40
	IN33.75TK48	48"	\$362	+\$26	+\$31	+\$45	+\$59	+\$109	+\$158	+\$220	+\$44

Description	Part number	List price	Accent paint upcharge
 Wall Mount Tackable Tile Kits	WMTL13	\$51	+\$6
	WMTL20	\$54	+\$7





Product code key example:

IN6.75NF18

IN Inscape System
6.75 6.75" high
NF nuform
18 18" wide

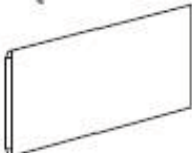
General information

- Stiffener bar prevents installation of this tile in any location where power track is installed in a 2 3/4" frame. See Inscape System Application Guide
- Some tile configurations require crossrails to be cut and additional crossrails ordered separately, See Inscape System Application Guide
- Be sure to confirm crossrail locations will accommodate tile height
- Crossrails can be found in the accessory section of the price list under Panel and Table accessories
- Due to limitations in the foil size, 48" and wider tiles are not available in F06 Walnut
- Direction of woodgrain is vertical

Description	Part number	Height	Width	List price
 6.75" H Nuform Tile	IN6.75NF18	6.75"	18"	\$203
	IN6.75NF24	6.75"	24"	\$211
	IN6.75NF30	6.75"	30"	\$217
	IN6.75NF36	6.75"	36"	\$222
	IN6.75NF42	6.75"	42"	\$227
	IN6.75NF48	6.75"	48"	\$233
 13.5" H Nuform Tile	IN13.5NF18	13.5"	18"	\$214
	IN13.5NF24	13.5"	24"	\$220
	IN13.5NF30	13.5"	30"	\$228
	IN13.5NF36	13.5"	36"	\$237
	IN13.5NF42	13.5"	42"	\$248
	IN13.5NF48	13.5"	48"	\$255
 20.25" H Nuform Tile	IN20.25NF18	20.25"	18"	\$246
	IN20.25NF24	20.25"	24"	\$256
	IN20.25NF30	20.25"	30"	\$274
	IN20.25NF36	20.25"	36"	\$288
	IN20.25NF42	20.25"	42"	\$299
	IN20.25NF48	20.25"	48"	\$311
 27" H Nuform Tile	IN27NF18	27"	18"	\$255
	IN27NF24	27"	24"	\$269
	IN27NF30	27"	30"	\$286
	IN27NF36	27"	36"	\$300
	IN27NF42	27"	42"	\$315
	IN27NF48	27"	48"	\$330

Architecture

Tiles

Nuform Patterned

Product code key example:

IN13.5NFPHE18

IN Inscape System
13.5 13.5" high
NFP Nuform patterned tile
HE herringbone
18 18" wide

General information





- Only available for use on 37", 44" and 51" high frames
- Patterned tiles must be applied in specific configurations based on the height of the frame in order for the pattern to line up correctly
- Due to limitations in the foil size, 48" and wider tiles are not available in F06 Walnut
- Direction of woodgrain is vertical

Notes

Patterned tiles cannot be used with the following as they will interfere with the installation:

- **Off-module brackets**
- **Power poles**
- **Worksurfaces front edge support brackets**
- **Up-mount bins**
- **Transaction Tops**
- **Electrical covers**
- **Dekko power tracks for 2 3/4" frames**

Can only be used on the outside face of a workstation

Description	Part number	Height	Width	2 3/4" thick frame	3 1/2" Thick frame
 13.5" H Nuform Patterned Tile, Herringbone for top location only	IN13.5NFPHE72	13.5"	72"	\$524	+\$18
	IN13.5NFPHE84	13.5"	84"	\$544	+\$39
	IN13.5NFPHE96	13.5"	96"	\$569	+\$43
 20.25" H Nuform Patterned Tile, Herringbone for top location only	IN20.25NFPHE72	20.25"	72"	\$581	+\$19
	IN20.25NFPHE84	20.25"	84"	\$609	+\$40
	IN20.25NFPHE96	20.25"	96"	\$646	+\$43
 20.25" H Nuform Patterned Tile, Herringbone for bottom location only	IN20.25NFPHEB72	20.25"	72"	\$581	+\$19
	IN20.25NFPHEB84	20.25"	84"	\$609	+\$40
	IN20.25NFPHEB96	20.25"	96"	\$646	+\$43
 27" H Nuform Patterned Tile, Herringbone for bottom location only	IN27NFPHEB72	27"	72"	\$736	+\$26
	IN27NFPHEB84	27"	84"	\$774	+\$59
	IN27NFPHEB96	27"	96"	\$823	+\$65





Product code key example:

IN6.75WV18

IN Inscape System
6.75 6.75" high
WV Composite veneer
18 18" wide

General information

- Stiffener bar prevents installation of this tile in any location where power track is installed in a 2 3/4" frame. See Inscape System Application Guide
- Some tile configurations require crossrails to be cut and additional crossrails ordered separately, See Inscape System Application Guide
- Be sure to confirm crossrail locations will accommodate tile height
- Crossrails can be found in the accessory section of the price list under Panel and Table accessories
- Direction of woodgrain is vertical

Description	Part number	Height	Width	List price
 6.75" H Veneer Tile	IN6.75WV18	6.75"	18"	\$228
	IN6.75WV24	6.75"	24"	\$234
	IN6.75WV30	6.75"	30"	\$239
	IN6.75WV36	6.75"	36"	\$245
	IN6.75WV42	6.75"	42"	\$250
	IN6.75WV48	6.75"	48"	\$255
 13.5" H Veneer Tile	IN13.5WV18	13.5"	18"	\$235
	IN13.5WV24	13.5"	24"	\$248
	IN13.5WV30	13.5"	30"	\$280
	IN13.5WV36	13.5"	36"	\$311
	IN13.5WV42	13.5"	42"	\$344
	IN13.5WV48	13.5"	48"	\$375
 20.25" H Veneer Tile	IN20.25WV18	20.25"	18"	\$265
	IN20.25WV24	20.25"	24"	\$309
	IN20.25WV30	20.25"	30"	\$356
	IN20.25WV36	20.25"	36"	\$403
	IN20.25WV42	20.25"	42"	\$448
	IN20.25WV48	20.25"	48"	\$495
 27" H Veneer Tile	IN27WV18	27"	18"	\$309
	IN27WV24	27"	24"	\$371
	IN27WV30	27"	30"	\$432
	IN27WV36	27"	36"	\$493
	IN27WV42	27"	42"	\$553
	IN27WV48	27"	48"	\$614

System

Architecture

Tiles

Whiteboard



Product code key example:

IN13.5WB18

IN Inscape System
13.5 13.5" high
WB whiteboard
18 18" wide

General information

- Only Expo Markers are to be used on any Inscape Whiteboard. Whiteboards should be cleaned with Expo Eraser or a Microfiber cleaning cloth along with Expo Cleaning Solution which is formulated to remove residue from Expo Dry Erase Markers
- Be sure to confirm crossrail locations will accommodate tile height
- Wall Mount Tile Kit must match height of tile
- Tiles 66"W or wider span two frames. See Application Guide for frame spanning guidelines

Description	Part number	Height	Width	List price
 13.5" H Whiteboard Tile	IN13.5WB18	13.5"	18"	\$82
	IN13.5WB24	13.5"	24"	\$86
	IN13.5WB30	13.5"	30"	\$89
	IN13.5WB36	13.5"	36"	\$91
	IN13.5WB42	13.5"	42"	\$93
	IN13.5WB48	13.5"	48"	\$98
	IN13.5WB54	13.5"	54"	\$109
	IN13.5WB60	13.5"	60"	\$114
	IN13.5WB66	13.5"	66"	\$197
	IN13.5WB72	13.5"	72"	\$202
	IN13.5WB78	13.5"	78"	\$212
	IN13.5WB84	13.5"	84"	\$217
IN13.5WB90	13.5"	90"	\$222	
IN13.5WB96	13.5"	96"	\$227	
 20.25" H Whiteboard Tile	IN20.25WB18	20.25"	18"	\$90
	IN20.25WB24	20.25"	24"	\$95
	IN20.25WB30	20.25"	30"	\$99
	IN20.25WB36	20.25"	36"	\$103
	IN20.25WB42	20.25"	42"	\$109
	IN20.25WB48	20.25"	48"	\$113
	IN20.25WB54	20.25"	54"	\$132
	IN20.25WB60	20.25"	60"	\$137
	IN20.25WB66	20.25"	66"	\$208
	IN20.25WB72	20.25"	72"	\$215
	IN20.25WB78	20.25"	78"	\$222
	IN20.25WB84	20.25"	84"	\$229
IN20.25WB90	20.25"	90"	\$236	
IN20.25WB96	20.25"	96"	\$244	
 Wall Mount Tackable Tile Kits	WMTL13	13.5"	—	\$51
	WMTL20	20.25"	—	\$54

Product code key example:

IN6.75PM18-3F



IN Inscape System
6.75 6.75" high
PM paper management
18 18" wide
3F 3 1/2" thick frame application

General information

- "2F" denotes use with 2 3/4" thick frame, "3F" denotes use with 3 1/2" thick frame
- Be sure to confirm crossrail locations will accommodate tile configuration
- Paper management tiles are not to be installed below the work surface
- Tiles 66"W or wider span two frames. See Application Guide for frame spanning guidelines

Notes

54" and 60" wide Paper Management tiles include reinforcing brackets

Description	Part number	Height	Width	Neutral paint/ base price	Accent paint upcharges
 <p>6.75" H Paper Management Tile for use with 3 1/2" T frames</p>	IN6.75PM18-3F	6.75"	18"	\$108	+\$12
	IN6.75PM24-3F	6.75"	24"	\$121	+\$13
	IN6.75PM30-3F	6.75"	30"	\$138	+\$15
	IN6.75PM36-3F	6.75"	36"	\$151	+\$16
	IN6.75PM42-3F	6.75"	42"	\$168	+\$18
	IN6.75PM48-3F	6.75"	48"	\$183	+\$19
	IN6.75PM54-3F	6.75"	54"	\$197	+\$21
	IN6.75PM60-3F	6.75"	60"	\$216	+\$23
	IN6.75PM66-3F	6.75"	66"	\$292	+\$30
	IN6.75PM72-3F	6.75"	72"	\$302	+\$31
	IN6.75PM78-3F	6.75"	78"	\$311	+\$32
	IN6.75PM84-3F	6.75"	84"	\$356	+\$36
	IN6.75PM90-3F	6.75"	90"	\$368	+\$38
IN6.75PM96-3F	6.75"	96"	\$379	+\$39	
 <p>6.75" H Paper Management Tile for use with 2 3/4" T frames</p>	IN6.75PM18-2F	6.75"	18"	\$108	+\$12
	IN6.75PM24-2F	6.75"	24"	\$121	+\$13
	IN6.75PM30-2F	6.75"	30"	\$138	+\$15
	IN6.75PM36-2F	6.75"	36"	\$151	+\$16
	IN6.75PM42-2F	6.75"	42"	\$168	+\$18
	IN6.75PM48-2F	6.75"	48"	\$183	+\$19
	IN6.75PM54-2F	6.75"	54"	\$197	+\$21
	IN6.75PM60-2F	6.75"	60"	\$216	+\$23
	IN6.75PM66-2F	6.75"	66"	\$285	+\$29
	IN6.75PM72-2F	6.75"	72"	\$296	+\$31
	IN6.75PM78-2F	6.75"	78"	\$306	+\$32
	IN6.75PM84-2F	6.75"	84"	\$349	+\$36
	IN6.75PM90-2F	6.75"	90"	\$360	+\$37
IN6.75PM96-2F	6.75"	96"	\$373	+\$38	

System

Architecture

Tiles

Paper Management Tile Reinforcing Kit



Product code key example:

INPMRK-3F

IN Inscape System
PM paper management
RK reinforcement kit
3F 3.5" thick frame

General information

- "2F" denotes use with 2.75" thick frame, "3F" denotes use with 3.5" thick frame
- When specifying monitor arms to mount on paper management tile, reinforcing bracket must be specified (frame thickness specific)
- Reinforcement Kit includes reinforcing brackets for Paper Management Tile

Description	Part number	Height	Width	List price
 Paper Management Reinforcing Kit for use with 3 1/2" T frames	INPMRK-3F	—	18"	\$108
 Paper Management Reinforcing Kit for use with 2 3/4" T frames	INPMRK-2F	—	18"	\$108



Product code key example:

IN13.5PF18

IN Inscape System
13.5 13.5" high
PF perforated
18 18" wide

General information

- Perforated tiles are available in any of Inscape's standard paint colours or a custom colour can be accommodated
- Painted tile is magnetic
- Be sure to confirm crossrail locations will accommodate tile height
- Crossrails can be found in the accessory section of the price list under Panel and Table accessories

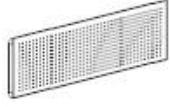
Description	Part number	Height	Width	Neutral paint/ base price	Accent paint upcharge
 13.5" H Perforated Tile	IN13.5PF18	13.5"	18"	\$64	+\$8
	IN13.5PF24	13.5"	24"	\$66	+\$8
	IN13.5PF30	13.5"	30"	\$73	+\$9
	IN13.5PF36	13.5"	36"	\$74	+\$9
	IN13.5PF42	13.5"	42"	\$75	+\$9
	IN13.5PF48	13.5"	48"	\$78	+\$9
	IN13.5PF54	13.5"	54"	\$79	+\$9
	IN13.5PF60	13.5"	60"	\$81	+\$9
 20.25" H Perforated Tile	IN20.25PF18	20.25"	18"	\$77	+\$9
	IN20.25PF24	20.25"	24"	\$79	+\$9
	IN20.25PF30	20.25"	30"	\$81	+\$9
	IN20.25PF36	20.25"	36"	\$86	+\$10
	IN20.25PF42	20.25"	42"	\$89	+\$10
	IN20.25PF48	20.25"	48"	\$93	+\$11
	IN20.25PF54	20.25"	54"	\$97	+\$11
	IN20.25PF60	20.25"	60"	\$100	+\$11
 27" H Perforated Tile	IN27PF18	27"	18"	\$88	+\$10
	IN27PF24	27"	24"	\$90	+\$10
	IN27PF30	27"	30"	\$92	+\$10
	IN27PF36	27"	36"	\$94	+\$11
	IN27PF42	27"	42"	\$102	+\$11
	IN27PF48	27"	48"	\$109	+\$12

System

Architecture

Tiles

Communication - Painted

Product code key example:

IN6.75CTP24-UD

IN Inscape System
6.75 6.75" high
CTP painted communication tile
24 24" wide
UD upper deck location





General information

- Painted tiles are available in any of Inscape's standard paint colours or a custom colour can be accommodated
- Painted tile is magnetic
- Specific locations where these tiles may be installed on frame; See Inscape System Application Guide
- Flush bezel color option of black, white and gray (default black)
- Be sure to confirm crossrail locations will accommodate tile height
- Crossrails can be found in the accessory section of the price list under Panel and Table accessories

Notes

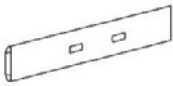
Code suffix denote specific tile location:

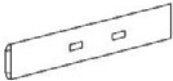
UD = Upper deck
BL = Beltline
BS = Base

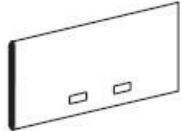
Description	Part number	Height	Width	Neutral paint/ base price	Accent paint upcharge
 <p>6.75" H Painted Communication Tile Upper Deck Location</p>	IN6.75CTP24-UD	6.75"	24"	\$61	+\$7
	IN6.75CTP30-UD	6.75"	30"	\$64	+\$8
	IN6.75CTP36-UD	6.75"	36"	\$65	+\$8
	IN6.75CTP42-UD	6.75"	42"	\$67	+\$8
	IN6.75CTP48-UD	6.75"	48"	\$69	+\$8
	IN6.75CTP54-UD	6.75"	54"	\$74	+\$9
	IN6.75CTP60-UD	6.75"	60"	\$77	+\$9
 <p>13.5" H Painted Communication Tile Upper Deck Location</p>	IN13.5CTP24-UD	13.5"	24"	\$85	+\$10
	IN13.5CTP30-UD	13.5"	30"	\$88	+\$10
	IN13.5CTP36-UD	13.5"	36"	\$93	+\$11
	IN13.5CTP42-UD	13.5"	42"	\$97	+\$11
	IN13.5CTP48-UD	13.5"	48"	\$102	+\$11
	IN13.5CTP54-UD	13.5"	54"	\$103	+\$12
	IN13.5CTP60-UD	13.5"	60"	\$106	+\$12
 <p>6.75" H Painted Communication Tile Beltline Location</p>	IN6.75CTP24-BL	6.75"	24"	\$61	+\$7
	IN6.75CTP30-BL	6.75"	30"	\$64	+\$8
	IN6.75CTP36-BL	6.75"	36"	\$65	+\$8
	IN6.75CTP42-BL	6.75"	42"	\$67	+\$8
	IN6.75CTP48-BL	6.75"	48"	\$69	+\$8
	IN6.75CTP54-BL	6.75"	54"	\$74	+\$9
	IN6.75CTP60-BL	6.75"	60"	\$77	+\$9
 <p>13.5" H Painted Communication Tile Beltline Location</p>	IN13.5CTP24-BL	13.5"	24"	\$85	+\$10
	IN13.5CTP30-BL	13.5"	30"	\$88	+\$10
	IN13.5CTP36-BL	13.5"	36"	\$93	+\$11
	IN13.5CTP42-BL	13.5"	42"	\$97	+\$11
	IN13.5CTP48-BL	13.5"	48"	\$102	+\$11
	IN13.5CTP54-BL	13.5"	54"	\$103	+\$12
	IN13.5CTP60-BL	13.5"	60"	\$106	+\$12
 <p>20.25" H Painted Communication Tile Bottom Location</p>	IN20.25CTP24-BS	20.25"	24"	\$106	+\$12
	IN20.25CTP30-BS	20.25"	30"	\$110	+\$12
	IN20.25CTP36-BS	20.25"	36"	\$117	+\$13
	IN20.25CTP42-BS	20.25"	42"	\$125	+\$14
	IN20.25CTP48-BS	20.25"	48"	\$130	+\$14
	IN20.25CTP54-BS	20.25"	54"	\$146	+\$16
	IN20.25CTP60-BS	20.25"	60"	\$149	+\$16

Product code key example:

IN6.75CTF24-UD

IN Inscape System
6.75 6.75" high
CTF fabric communication tile
24 24" wide
UD upper deck location

General information

- Fabric applied in a railroad orientation as standard
- Fabric tile is magnetic.
- Specific locations where these tiles may be installed on frame; See Inscape System Application Guide
- Flush bezel color option of black, white and gray (default black)
- Be sure to confirm crossrail locations will accommodate tile height
- Crossrails can be found in the accessory section of the price list under Panel and Table accessories

Notes

Code suffix denote specific tile location:

UD = Upper deck
BL = Beltline
BS = Base





See finishes section for fabrics that requires scrim

Tile size limitations exist for some fabrics, see finishes section

In order to get a total cost on products when upcharges are present take the list price of the product number and add the upcharge cost shown to the list price.

For example:

Product IN6.75CTF24-UD in Grade 2 with scrim would be \$78 +\$4 +\$11

Description	Part number	Width	Grade 1/COM	Grade 2	Grade 3	Grade 4	Grade 5	Grade 6	Grade 7	Grade 8	Scrim
 6.75" H Fabric Communication Tile Upper Deck Location	IN6.75CTF24-UD	24"	\$78	+\$4	+\$6	+\$10	+\$14	+\$30	+\$45	+\$63	+\$11
	IN6.75CTF30-UD	30"	\$80	+\$4	+\$6	+\$10	+\$14	+\$30	+\$45	+\$63	+\$11
	IN6.75CTF36-UD	36"	\$91	+\$6	+\$9	+\$17	+\$25	+\$44	+\$64	+\$89	+\$12
	IN6.75CTF42-UD	42"	\$95	+\$7	+\$8	+\$16	+\$23	+\$42	+\$62	+\$87	+\$12
	IN6.75CTF48-UD	48"	\$98	+\$7	+\$10	+\$18	+\$25	+\$45	+\$66	+\$92	+\$12
	IN6.75CTF54-UD	54"	\$103	+\$8	+\$10	+\$18	+\$25	+\$46	+\$67	+\$94	+\$12
	IN6.75CTF60-UD	60"	\$113	+\$8	+\$10	+\$20	+\$29	+\$54	+\$78	+\$109	+\$13
 13.5" H Fabric Communication Tile Upper Deck Location	IN13.5CTF24-UD	24"	\$98	+\$6	+\$11	+\$19	+\$26	+\$46	+\$67	+\$94	+\$12
	IN13.5CTF30-UD	30"	\$102	+\$5	+\$9	+\$17	+\$24	+\$45	+\$66	+\$92	+\$13
	IN13.5CTF36-UD	36"	\$113	+\$6	+\$12	+\$23	+\$33	+\$59	+\$84	+\$117	+\$13
	IN13.5CTF42-UD	42"	\$116	+\$7	+\$16	+\$24	+\$32	+\$61	+\$86	+\$121	+\$14
	IN13.5CTF48-UD	48"	\$120	+\$9	+\$21	+\$30	+\$38	+\$65	+\$92	+\$128	+\$14
	IN13.5CTF54-UD	54"	\$121	+\$10	+\$23	+\$33	+\$42	+\$71	+\$98	+\$138	+\$16
	IN13.5CTF60-UD	60"	\$132	+\$11	+\$12	+\$23	+\$34	+\$63	+\$91	+\$127	+\$16
 6.75" H Fabric Communication Tile Beltline Location	IN6.75CTF24-BL	24"	\$78	+\$4	+\$6	+\$10	+\$14	+\$30	+\$45	+\$63	+\$11
	IN6.75CTF30-BL	30"	\$80	+\$4	+\$6	+\$10	+\$14	+\$30	+\$45	+\$63	+\$11
	IN6.75CTF36-BL	36"	\$91	+\$6	+\$7	+\$17	+\$21	+\$44	+\$64	+\$89	+\$12
	IN6.75CTF42-BL	42"	\$95	+\$7	+\$8	+\$17	+\$23	+\$42	+\$62	+\$87	+\$12
	IN6.75CTF48-BL	48"	\$98	+\$7	+\$9	+\$18	+\$25	+\$45	+\$66	+\$92	+\$12
	IN6.75CTF54-BL	54"	\$103	+\$8	+\$10	+\$18	+\$25	+\$46	+\$67	+\$94	+\$12
	IN6.75CTF60-BL	60"	\$113	+\$8	+\$10	+\$20	+\$29	+\$54	+\$78	+\$109	+\$13
 13.5" H Fabric Communication Tile Beltline Location	IN13.5CTF24-BL	24"	\$98	+\$5	+\$11	+\$19	+\$26	+\$46	+\$67	+\$94	+\$12
	IN13.5CTF30-BL	30"	\$102	+\$6	+\$11	+\$21	+\$29	+\$45	+\$66	+\$92	+\$13
	IN13.5CTF36-BL	36"	\$113	+\$6	+\$12	+\$23	+\$33	+\$59	+\$84	+\$117	+\$13
	IN13.5CTF42-BL	42"	\$116	+\$7	+\$16	+\$24	+\$35	+\$61	+\$86	+\$124	+\$14
	IN13.5CTF48-BL	48"	\$120	+\$9	+\$21	+\$30	+\$38	+\$65	+\$92	+\$128	+\$14
	IN13.5CTF54-BL	54"	\$121	+\$10	+\$23	+\$33	+\$42	+\$71	+\$98	+\$138	+\$16
	IN13.5CTF60-BL	60"	\$132	+\$11	+\$23	+\$34	+\$44	+\$73	+\$100	+\$140	+\$16
 20.25" H Fabric Communication Tile Bottom Location	IN20.25CTF24-BS	24"	\$118	+\$5	+\$17	+\$26	+\$34	+\$61	+\$87	+\$121	+\$23
	IN20.25CTF30-BS	30"	\$120	+\$4	+\$18	+\$27	+\$36	+\$63	+\$89	+\$124	+\$24
	IN20.25CTF36-BS	36"	\$140	+\$6	+\$18	+\$29	+\$40	+\$72	+\$102	+\$143	+\$25
	IN20.25CTF42-BS	42"	\$144	+\$7	+\$21	+\$32	+\$43	+\$75	+\$108	+\$151	+\$26
	IN20.25CTF48-BS	48"	\$148	+\$9	+\$24	+\$36	+\$47	+\$82	+\$115	+\$161	+\$26
	IN20.25CTF54-BS	54"	\$151	+\$9	+\$26	+\$39	+\$52	+\$89	+\$124	+\$174	+\$27
	IN20.25CTF60-BS	60"	\$155	+\$10	+\$34	+\$49	+\$64	+\$102	+\$140	+\$195	+\$28

System

Architecture

Tiles

Multi Access - Painted

Product code key example:

IN6.75MAP30-UD

IN Inscape System
6.75 6.75" high
MAP painted multi access tile
30 30" wide
UD upper deck location



General information

- Painted tiles are available in any of Inscape's standard paint colours or a custom colour can be accommodated
- Painted tile is magnetic
- Specific locations where these tiles may be installed on frame; See Inscape System Application Guide
- Flush bezel color option of black (default), white and gray
- Be sure to confirm crossrail locations will accommodate tile height
- Crossrails can be found in the accessory section of the price list under Panel and Table accessories

Notes

Code suffix denote specific tile location:

UD = Upper deck
BL = Beltline
BS = Base

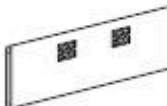
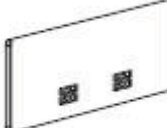
Description	Part number	Height	Width	Neutral paint/ base price	Accent paint upcharge
 6.75" H Painted Multi Access Tile Upper Deck Location	IN6.75MAP30-UD	6.75"	30"	\$64	+\$8
	IN6.75MAP36-UD	6.75"	36"	\$65	+\$8
	IN6.75MAP42-UD	6.75"	42"	\$67	+\$8
	IN6.75MAP48-UD	6.75"	48"	\$69	+\$8
	IN6.75MAP54-UD	6.75"	54"	\$74	+\$9
	IN6.75MAP60-UD	6.75"	60"	\$77	+\$9
 13.5" H Painted Multi Access Tile Upper Deck Location	IN13.5MAP30-UD	13.5"	30"	\$89	+\$10
	IN13.5MAP36-UD	13.5"	36"	\$93	+\$11
	IN13.5MAP42-UD	13.5"	42"	\$97	+\$11
	IN13.5MAP48-UD	13.5"	48"	\$102	+\$11
	IN13.5MAP54-UD	13.5"	54"	\$103	+\$12
	IN13.5MAP60-UD	13.5"	60"	\$106	+\$12
 6.75" H Painted Multi Access Tile Beltline Location	IN6.75MAP30-BL	6.75"	30"	\$64	+\$8
	IN6.75MAP36-BL	6.75"	36"	\$65	+\$8
	IN6.75MAP42-BL	6.75"	42"	\$67	+\$8
	IN6.75MAP48-BL	6.75"	48"	\$69	+\$8
	IN6.75MAP54-BL	6.75"	54"	\$74	+\$9
	IN6.75MAP60-BL	6.75"	60"	\$77	+\$9
 13.5" H Painted Multi Access Tile Beltline Location	IN13.5MAP30-BL	13.5"	30"	\$89	+\$10
	IN13.5MAP36-BL	13.5"	36"	\$93	+\$11
	IN13.5MAP42-BL	13.5"	42"	\$97	+\$11
	IN13.5MAP48-BL	13.5"	48"	\$102	+\$11
	IN13.5MAP54-BL	13.5"	54"	\$103	+\$12
	IN13.5MAP60-BL	13.5"	60"	\$106	+\$12
 20.25" H Painted Multi Access Tile Bottom Location	IN20.25MAP30-BS	20.25"	30"	\$119	+\$13
	IN20.25MAP36-BS	20.25"	36"	\$121	+\$13
	IN20.25MAP42-BS	20.25"	42"	\$128	+\$14
	IN20.25MAP48-BS	20.25"	48"	\$135	+\$15
	IN20.25MAP54-BS	20.25"	54"	\$151	+\$16
	IN20.25MAP60-BS	20.25"	60"	\$154	+\$17

Product code key example:

IN6.75MAF30

IN Inscape System
6.75 6.75" high
MAF multi access fabric
30 30" wide

General information

- Fabric applied in a railroad orientation as standard
- Fabric tile is magnetic.
- Specific locations where these tiles may be installed on frame; See Inscape System Application Guide
- Flush bezel color option of black (default), white and gray
- Be sure to confirm crossrail locations will accommodate tile height
- Crossrails can be found in the accessory section of the price list under Panel and Table accessories

Notes

Code suffix denote specific tile location:

UD = Upper deck
BL = Beltline
BS = Base





See finishes section for fabrics that requires scrim

Tile size limitations exist for some fabrics, see finishes section

In order to get a total cost on products when upcharges are present take the list price of the product number and add the upcharge cost shown to the list price.

For example:

Product IN6.75MAF30-UD in Grade 2 with scrim would be \$81 +\$4 +\$11

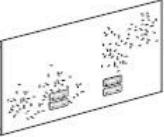
Description	Part number	Width	Grade 1/COM	Grade 2	Grade 3	Grade 4	Grade 5	Grade 6	Grade 7	Grade 8	Scrim
 6.75" H Fabric Multi Access Tile Upper Deck Location	IN6.75MAF30-UD	30"	\$81	+\$4	+\$6	+\$10	+\$14	+\$30	+\$45	+\$63	+\$11
	IN6.75MAF36-UD	36"	\$91	+\$6	+\$9	+\$17	+\$21	+\$42	+\$60	+\$83	+\$12
	IN6.75MAF42-UD	42"	\$95	+\$7	+\$8	+\$17	+\$23	+\$44	+\$62	+\$87	+\$12
	IN6.75MAF48-UD	48"	\$98	+\$7	+\$10	+\$18	+\$25	+\$45	+\$66	+\$92	+\$12
	IN6.75MAF54-UD	54"	\$103	+\$8	+\$10	+\$18	+\$25	+\$46	+\$67	+\$94	+\$12
	IN6.75MAF60-UD	60"	\$113	+\$8	+\$10	+\$20	+\$29	+\$54	+\$78	+\$109	+\$13
 13.5" H Fabric Multi Access Tile Upper Deck Location	IN13.5MAF30-UD	30"	\$103	+\$5	+\$9	+\$17	+\$24	+\$45	+\$66	+\$92	+\$13
	IN13.5MAF36-UD	36"	\$113	+\$6	+\$12	+\$23	+\$33	+\$59	+\$84	+\$117	+\$13
	IN13.5MAF42-UD	42"	\$116	+\$7	+\$19	+\$24	+\$36	+\$62	+\$89	+\$124	+\$14
	IN13.5MAF48-UD	48"	\$120	+\$9	+\$21	+\$30	+\$38	+\$65	+\$92	+\$128	+\$14
	IN13.5MAF54-UD	54"	\$121	+\$10	+\$23	+\$33	+\$42	+\$71	+\$98	+\$138	+\$16
	IN13.5MAF60-UD	60"	\$132	+\$11	+\$25	+\$35	+\$44	+\$74	+\$100	+\$140	+\$16
 6.75" H Fabric Multi Access Tile Beltline Location	IN6.75MAF30-BL	30"	\$81	+\$4	+\$6	+\$10	+\$14	+\$30	+\$45	+\$63	+\$11
	IN6.75MAF36-BL	36"	\$91	+\$6	+\$8	+\$17	+\$22	+\$40	+\$52	+\$75	+\$12
	IN6.75MAF42-BL	42"	\$95	+\$7	+\$8	+\$17	+\$23	+\$42	+\$62	+\$87	+\$12
	IN6.75MAF48-BL	48"	\$98	+\$7	+\$10	+\$18	+\$25	+\$45	+\$66	+\$92	+\$12
	IN6.75MAF54-BL	54"	\$103	+\$8	+\$10	+\$18	+\$25	+\$46	+\$67	+\$94	+\$12
	IN6.75MAF60-BL	60"	\$113	+\$8	+\$10	+\$20	+\$29	+\$54	+\$78	+\$109	+\$13
 13.5" H Fabric Multi Access Tile Beltline Location	IN13.5MAF30-BL	30"	\$103	+\$4	+\$9	+\$17	+\$24	+\$45	+\$66	+\$92	+\$13
	IN13.5MAF36-BL	36"	\$113	+\$6	+\$12	+\$23	+\$29	+\$56	+\$82	+\$104	+\$13
	IN13.5MAF42-BL	42"	\$116	+\$5	+\$16	+\$24	+\$32	+\$58	+\$84	+\$117	+\$14
	IN13.5MAF48-BL	48"	\$120	+\$9	+\$21	+\$30	+\$38	+\$65	+\$92	+\$128	+\$14
	IN13.5MAF54-BL	54"	\$121	+\$10	+\$23	+\$33	+\$42	+\$71	+\$98	+\$138	+\$16
	IN13.5MAF60-BL	60"	\$132	+\$3	+\$12	+\$23	+\$34	+\$63	+\$91	+\$127	+\$16
 20.25" H Fabric Multi Access Tile Bottom Location	IN20.25MAF30-BS	30"	\$121	+\$4	+\$18	+\$27	+\$36	+\$63	+\$89	+\$124	+\$24
	IN20.25MAF36-BS	36"	\$140	+\$6	+\$18	+\$29	+\$40	+\$72	+\$102	+\$143	+\$25
	IN20.25MAF42-BS	42"	\$144	+\$6	+\$16	+\$28	+\$39	+\$72	+\$102	+\$143	+\$26
	IN20.25MAF48-BS	48"	\$148	+\$9	+\$24	+\$36	+\$47	+\$82	+\$115	+\$161	+\$26
	IN20.25MAF54-BS	54"	\$151	+\$9	+\$26	+\$39	+\$52	+\$89	+\$124	+\$174	+\$27
	IN20.25MAF60-BS	60"	\$155	+\$11	+\$28	+\$49	+\$64	+\$102	+\$140	+\$195	+\$28

System

Architecture

Tiles

Double Glazed

Product code key example:

IN13.5GL24-3F

IN Inscape System
13.5 13.5" high
GL double glaze
24 24" wide
3F for 3.5" thick frame

General information

- "2F" denotes use with 2 ¾" thick frame, "3F" denotes use with 3 ½" thick frame
- Be sure to confirm crossrail locations will accommodate tile height
- Crossrails can be found in the accessory section of the price list under Panel and Table accessories

Notes

Standard tiles may NOT be installed in locations above Double Glaze Tile on the 2 ¾" thick frame

In order to get a total cost on products when upcharges are present take the list price of the product number and add the upcharge cost shown to the list price.

For example:

IN13.5GL24-3F in Frosted Acrylic would be \$286 +\$34

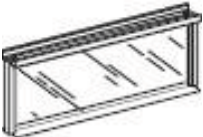
Description	Part number	Height	Width	Clear acrylic	Frosted acrylic	Accent paint upcharge
 Double Glaze Tile for 3 ½" Frames	IN13.5GL24-3F	13.5"	24"	\$286	+\$34	+\$30
	IN13.5GL30-3F	13.5"	30"	\$298	+\$46	+\$31
	IN13.5GL36-3F	13.5"	36"	\$309	+\$49	+\$32
	IN13.5GL42-3F	13.5"	42"	\$331	+\$75	+\$34
	IN13.5GL48-3F	13.5"	48"	\$340	+\$84	+\$35
 Double Glaze Tile for 2 ¾" Frames	IN13.5GL24-2F	13.5"	24"	\$275	+\$34	+\$28
	IN13.5GL30-2F	13.5"	30"	\$288	+\$46	+\$30
	IN13.5GL36-2F	13.5"	36"	\$299	+\$49	+\$31
	IN13.5GL42-2F	13.5"	42"	\$321	+\$75	+\$33
	IN13.5GL48-2F	13.5"	48"	\$329	+\$84	+\$34





Product code key example:

IN37P18

IN Inscape System
37 37" high
P painted
18 18" wide

General information

- Painted tiles are available in any of Inscape's standard paint colours or a custom colour can be accommodated
- Painted tile is magnetic.
- Be sure to confirm crossrail locations will accommodate tile height
- Crossrails can be found in the accessory section of the price list under Panel and Table accessories

Description	Part number	Height	Width	Neutral paint/ base price	Accent paint upcharge
	37" H Painted Monolithic Tile				
	IN37P18	37"	18"	\$148	+\$16
	IN37P24	37"	24"	\$153	+\$16
	IN37P30	37"	30"	\$156	+\$17
	IN37P36	37"	36"	\$161	+\$17
	IN37P42	37"	42"	\$163	+\$17
IN37P48	37"	48"	\$166	+\$18	
	44" H Painted Monolithic Tile				
	IN44P18	44"	18"	\$170	+\$18
	IN44P24	44"	24"	\$176	+\$19
	IN44P30	44"	30"	\$183	+\$19
	IN44P36	44"	36"	\$189	+\$20
	IN44P42	44"	42"	\$195	+\$21
IN44P48	44"	48"	\$200	+\$21	
	51" H Painted Monolithic Tile				
	IN51P18	51"	18"	\$181	+\$19
	IN51P24	51"	24"	\$190	+\$20
	IN51P30	51"	30"	\$194	+\$21
	IN51P36	51"	36"	\$200	+\$21
	IN51P42	51"	42"	\$211	+\$22
IN51P48	51"	48"	\$219	+\$23	
	57" H Painted Monolithic Tile				
	IN57P18	57"	18"	\$192	+\$20
	IN57P24	57"	24"	\$200	+\$21
	IN57P30	57"	30"	\$212	+\$22
	IN57P36	57"	36"	\$218	+\$23
	IN57P42	57"	42"	\$226	+\$24
IN57P48	57"	48"	\$236	+\$25	
	64" H Painted Monolithic Tile				
	IN64P18	64"	18"	\$214	+\$22
	IN64P24	64"	24"	\$227	+\$24
	IN64P30	64"	30"	\$241	+\$25
	IN64P36	64"	36"	\$256	+\$27
	IN64P42	64"	42"	\$266	+\$28
IN64P48	64"	48"	\$275	+\$28	

Architecture

Tiles

Monolithic - Fabric

Product code key example:

IN37F18

IN Inscape System
37 37" high
F fabric
18 18" wide

General information

- Fabric applied in a railroad orientation as standard
- Fabric tile is magnetic
- Be sure to confirm crossrail locations will accommodate tile height
- Crossrails can be found in the accessory section of the price list under Panel and Table accessories

Notes





See finishes section for fabrics that requires scrim

Tile size limitations exist for some fabrics, see finishes section

In order to get a total cost on products when upcharges are present take the list price of the product number and add the upcharge cost shown to the list price.

For example:

Product IN37F18 in Grade 2 with scrim would be \$224 +\$11 +\$28

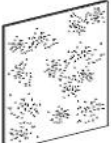
Description	Part number	Width	Grade 1/COM	Grade 2	Grade 3	Grade 4	Grade 5	Grade 6	Grade 7	Grade 8	Scrim
	IN37F18	18"	\$224	+\$11	+\$17	+\$25	+\$32	+\$63	+\$94	+\$131	+\$28
	IN37F24	24"	\$235	+\$12	+\$18	+\$25	+\$32	+\$65	+\$97	+\$135	+\$36
	IN37F30	30"	\$246	+\$12	+\$18	+\$26	+\$33	+\$67	+\$101	+\$142	+\$45
	IN37F36	36"	\$256	+\$25	+\$29	+\$43	+\$57	+\$102	+\$147	+\$205	+\$54
	IN37F42	42"	\$270	+\$25	+\$30	+\$43	+\$57	+\$104	+\$151	+\$212	+\$62
	IN37F48	48"	\$280	+\$26	+\$31	+\$45	+\$59	+\$109	+\$158	+\$220	+\$72
37" H Fabric Monolithic Tile											
	IN44F18	18"	\$249	+\$16	+\$19	+\$28	+\$37	+\$71	+\$103	+\$145	+\$33
	IN44F24	24"	\$264	+\$16	+\$19	+\$28	+\$37	+\$73	+\$108	+\$150	+\$44
	IN44F30	30"	\$277	+\$18	+\$21	+\$29	+\$38	+\$76	+\$112	+\$156	+\$55
	IN44F36	36"	\$290	+\$28	+\$34	+\$37	+\$63	+\$115	+\$167	+\$236	+\$65
	IN44F42	42"	\$302	+\$28	+\$34	+\$48	+\$66	+\$120	+\$173	+\$239	+\$77
	IN44F48	48"	\$317	+\$28	+\$34	+\$50	+\$66	+\$120	+\$173	+\$241	+\$87
44" H Fabric Monolithic Tile											
	IN51F18	18"	\$272	+\$17	+\$21	+\$31	+\$39	+\$76	+\$111	+\$154	+\$38
	IN51F24	24"	\$285	+\$18	+\$22	+\$32	+\$42	+\$82	+\$120	+\$168	+\$51
	IN51F30	30"	\$298	+\$20	+\$23	+\$34	+\$49	+\$84	+\$124	+\$176	+\$64
	IN51F36	36"	\$310	+\$29	+\$25	+\$54	+\$70	+\$121	+\$172	+\$240	+\$78
	IN51F42	42"	\$325	+\$30	+\$38	+\$55	+\$71	+\$124	+\$178	+\$248	+\$90
	IN51F48	48"	\$337	+\$32	+\$40	+\$57	+\$74	+\$126	+\$182	+\$254	+\$103
51" H Fabric Monolithic Tile											
	IN57F18	18"	\$283	+\$22	+\$27	+\$38	+\$48	+\$90	+\$131	+\$183	+\$43
	IN57F24	24"	\$297	+\$24	+\$28	+\$39	+\$50	+\$96	+\$141	+\$196	+\$57
	IN57F30	30"	\$310	+\$29	+\$32	+\$40	+\$52	+\$100	+\$147	+\$205	+\$72
	IN57F36	36"	\$326	+\$36	+\$41	+\$66	+\$84	+\$145	+\$206	+\$288	+\$85
	IN57F42	42"	\$342	+\$37	+\$45	+\$69	+\$85	+\$147	+\$210	+\$292	+\$99
	IN57F48	48"	\$357	+\$38	+\$47	+\$71	+\$86	+\$151	+\$217	+\$302	+\$113
57" H Fabric Monolithic Tile											
	IN64F18	18"	\$302	+\$22	+\$27	+\$38	+\$48	+\$90	+\$131	+\$183	+\$48
	IN64F24	24"	\$321	+\$24	+\$29	+\$39	+\$50	+\$96	+\$141	+\$196	+\$64
	IN64F30	30"	\$336	+\$28	+\$34	+\$40	+\$52	+\$100	+\$147	+\$205	+\$81
	IN64F36	36"	\$354	+\$32	+\$47	+\$66	+\$84	+\$145	+\$206	+\$288	+\$97
	IN64F42	42"	\$374	+\$36	+\$48	+\$69	+\$88	+\$147	+\$210	+\$292	+\$113
	IN64F48	48"	\$390	+\$38	+\$50	+\$71	+\$90	+\$151	+\$217	+\$302	+\$129
64" H Fabric Monolithic Tile											

Product code key example:

IN37MAP30B



IN Inscape System
37 37" high
MAP multi access - painted
30 30" wide
B base cut outs

General information

- Painted tiles are available in any of Inscape's standard paint colours or a custom colour can be accommodated
- Painted tile is magnetic
- Flush bezel color option of black (default), white and gray
- Be sure to confirm crossrail locations will accommodate tile height
- Crossrails can be found in the accessory section of the price list under Panel and Table accessories

Notes

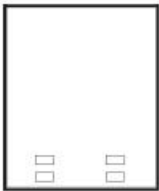
Multi access location at base only (includes 2 data cut outs and 2 electrical cut outs)

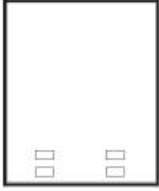
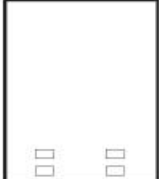
Description	Part number	Height	Width	Neutral paint/ base price	Accent paint upcharge
 37" H Painted Monolithic Tile with Multi Access	IN37MAP30B	37"	30"	\$162	+\$17
	IN37MAP36B	37"	36"	\$170	+\$18
	IN37MAP42B	37"	42"	\$176	+\$19
	IN37MAP48B	37"	48"	\$180	+\$19
 44" H Painted Monolithic Tile with Multi Access	IN44MAP30B	44"	30"	\$189	+\$20
	IN44MAP36B	44"	36"	\$198	+\$21
	IN44MAP42B	44"	42"	\$206	+\$22
	IN44MAP48B	44"	48"	\$214	+\$22
 51" H Painted Monolithic Tile with Multi Access	IN51MAP30B	51"	30"	\$197	+\$21
	IN51MAP36B	51"	36"	\$212	+\$22
	IN51MAP42B	51"	42"	\$219	+\$23
	IN51MAP48B	51"	48"	\$226	+\$24
 57" H Painted Monolithic Tile with Multi Access	IN57MAP30B	57"	30"	\$216	+\$23
	IN57MAP36B	57"	36"	\$227	+\$24
	IN57MAP42B	57"	42"	\$237	+\$25
	IN57MAP48B	57"	48"	\$246	+\$26
 64" H Painted Monolithic Tile with Multi Access	IN64MAP30B	64"	30"	\$244	+\$25
	IN64MAP36B	64"	36"	\$261	+\$27
	IN64MAP42B	64"	42"	\$269	+\$28
	IN64MAP48B	64"	48"	\$278	+\$29

Architecture

Tiles

Monolithic with Multi Access - Fabric

Product code key example:

IN37MAF30B

IN	Inscape System
37	37" high
MAF	multi access - fabric
30	30" wide
B	base cut outs

General information

- Fabric applied in a railroad orientation
- Flush bezel color option of black (default), white and gray
- Be sure to confirm crossrail locations will accommodate tile height
- Crossrails can be found in the accessory section of the price list under Panel and Table accessories

Notes

Multi access location at base only (includes 2 data cut outs and 2 electrical cut outs)

See finishes section for fabrics that requires scrim

Tile size limitations exist for some fabrics, see finishes section

In order to get a total cost on products when upcharges are present take the list price of the product number and add the upcharge cost shown to the list price.

For example:

Product IN37MAF30B in Grade 2 with scrim would be \$255 +\$12 +\$45

Description	Part number	Width	Grade 1/COM	Grade 2	Grade 3	Grade 4	Grade 5	Grade 6	Grade 7	Grade 8	Scrim
	IN37MAF30B	30"	\$255	+\$12	+\$18	+\$26	+\$33	+\$67	+\$101	+\$142	+\$45
	IN37MAF36B	36"	\$272	+\$25	+\$29	+\$39	+\$50	+\$102	+\$147	+\$205	+\$54
	IN37MAF42B	42"	\$283	+\$25	+\$30	+\$43	+\$57	+\$104	+\$151	+\$212	+\$62
	IN37MAF48B	48"	\$294	+\$26	+\$31	+\$45	+\$59	+\$109	+\$158	+\$220	+\$72

37" H Fabric
Monolithic Tile with
Multi Access

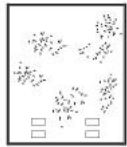

IN44MAF30B	30"	\$288	+\$16	+\$19	+\$29	+\$38	+\$76	+\$112	+\$156	+\$55
IN44MAF36B	36"	\$303	+\$28	+\$34	+\$50	+\$66	+\$120	+\$173	+\$241	+\$65
IN44MAF42B	42"	\$317	+\$31	+\$36	+\$52	+\$70	+\$124	+\$177	+\$247	+\$77
IN44MAF48B	48"	\$330	+\$33	+\$39	+\$55	+\$73	+\$128	+\$181	+\$250	+\$87

44" H Fabric
Monolithic Tile with
Multi Access

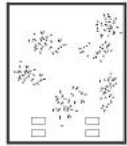

IN51MAF30B	30"	\$300	+\$18	+\$22	+\$32	+\$42	+\$100	+\$120	+\$168	+\$64
IN51MAF36B	36"	\$318	+\$29	+\$36	+\$54	+\$70	+\$121	+\$172	+\$240	+\$78
IN51MAF42B	42"	\$331	+\$30	+\$38	+\$55	+\$71	+\$124	+\$178	+\$248	+\$90
IN51MAF48B	48"	\$346	+\$31	+\$40	+\$57	+\$73	+\$126	+\$182	+\$254	+\$103

51" H Fabric
Monolithic Tile with
Multi Access

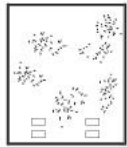

IN57MAF30B	30"	\$323	+\$24	+\$28	+\$40	+\$52	+\$100	+\$147	+\$205	+\$72
IN57MAF36B	36"	\$343	+\$36	+\$33	+\$62	+\$64	+\$145	+\$206	+\$288	+\$85
IN57MAF42B	42"	\$358	+\$37	+\$42	+\$63	+\$78	+\$147	+\$210	+\$292	+\$99
IN57MAF48B	48"	\$375	+\$38	+\$47	+\$67	+\$86	+\$151	+\$217	+\$302	+\$113

57" H Fabric
Monolithic Tile with
Multi Access

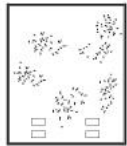

IN64MAF30B	30"	\$354	+\$24	+\$28	+\$40	+\$52	+\$100	+\$147	+\$205	+\$81
IN64MAF36B	36"	\$394	+\$30	+\$33	+\$54	+\$64	+\$145	+\$206	+\$288	+\$97
IN64MAF42B	42"	\$408	+\$32	+\$42	+\$63	+\$78	+\$147	+\$210	+\$292	+\$113
IN64MAF48B	48"	\$421	+\$38	+\$47	+\$67	+\$86	+\$151	+\$217	+\$302	+\$129

64" H Fabric
Monolithic Tile with
Multi Access

Product code key example:

IN6.75MAP30

INPL Inscape System Planna
6.75 6.75" high
MAP multi access - painted
30 30" wide

General information

- Use with 3.5" thick panel only
- Paint finish only
- Painted tiles are available in any of Inscape's standard paint colours or a custom colour can be accommodated
- Painted tile is magnetic
- Flush bezel color option of black (default), white and gray
- Be sure to confirm crossrail locations will accommodate tile height
- Crossrails can be found in the accessory section of the price list under Panel and Table accessories

Description	Part number	Height	Width	Neutral paint/ base price	Accent paint upcharge
 6.75" H Painted Multi Access Tile for use with Planna Storage	INPL6.75MAP30	6.75"	30"	\$90	+\$10
	INPL6.75MAP36	6.75"	36"	\$93	+\$11
	INPL6.75MAP42	6.75"	42"	\$99	+\$11

Left blank intentionally.

system

Technology

General information

Inscape System electrical is UL and CSA approved. New York City and Chicago solutions are also available as standard offering. The electrical system features 8 wires and 4 circuits that can be configured in a 2+2 or 3+1 circuit configuration. All electrical components, with the exception of the power feed (which must be connected to the building power supply by a licensed electrician) may be installed by furniture installers, unless otherwise stated by jurisdiction of the installation.

Inscape System electrical components consist of the following: Floor/Wall power in-feed, ceiling power in-feed, chimney feed, power tracks, jumper cables and duplex receptacles. Power components snap into place without the need of tools.

Power in-feed connections

Power in-feed connections can be made through a wall, column, or floor connection. Power in-feed connections consist of an 84" long liquid tight cable and a 45" flex cable connected by a 3" metal coupler and elbow joint to sit between bottom rails. The liquid tight portion of the Power in-feed must be connected to the building power supply by an electrician.

If two power feeds are being specified for one cluster of stations, care must be taken not to cross connect the two feeds through jumper cables and power tracks.

New York City has requirements for special power entry assemblies. A qualified electrician is required to hard-wire the **New York City In-feed** from the entry box to the power source. The New York City feed works for side feed, end feed or ceiling feed.

The City of Chicago does not permit the use of pre-wired modular electrical systems. To simplify hardwiring of the Inscape System panel, the **City of Chicago Hold Down Bracket** is available. When requiring power and data in the beltline location, it is required that basic frames be specified with the width specific code (ECHB-BL-). The beltline location code includes the beltline cover as well as the City of Chicago Hold Down bracket which is based on the width of the frame. When specifying in locations other than at the beltline, an attachment bracket (INECHB) is available. Specify two INECHB for each power entry point, one for the power feed and one for the outlet. (The outlet box is NOT supplied by Inscape). INECHB's are available in packages of 6. **Boxes should be sourced through Ental Industries or J&A Sheet both local Chicago suppliers of electrical junction boxes.**

Note: Panels 30" wide will accept one double-sided outlet box. Panels 36" wide and wider will accept two boxes. INECHB's may also be specified to mount multi-user termination boxes inside the panel.

Wire designation

2 + 2 Circuit Configuration

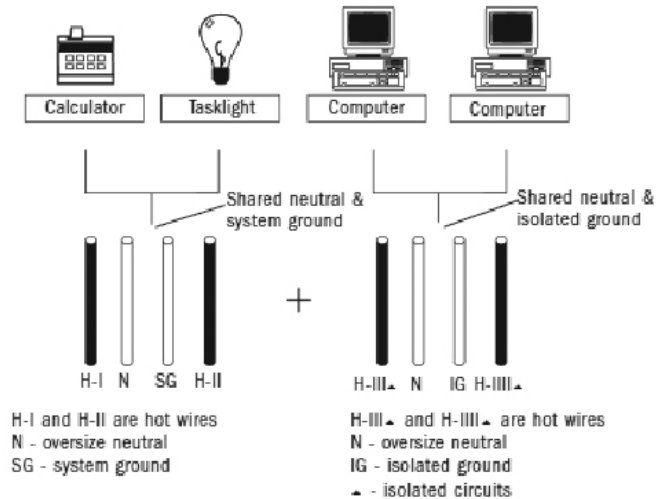

2+2

- Circuits #1 and #2 share one oversized neutral and one shared ground to provide convenience power for task lights, calculators, radios etc.
- Circuits #3 and #4 share the other oversized neutral and isolated ground to provide isolated power to computers.

3 + 1 Circuit Configuration

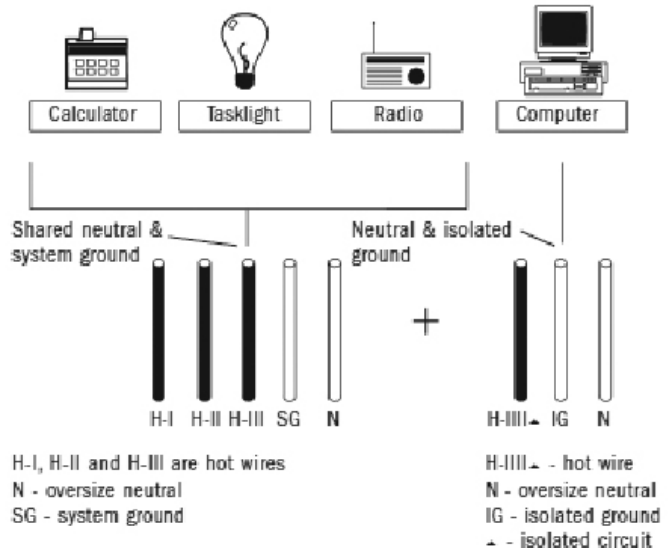

3+1

- Circuits #1, #2 and #3 share one oversized neutral and one shared ground to provide convenience power for task lights, calculators, radios etc.
- Circuit #4 uses the other oversized neutral and isolated ground to provide isolated power to computers.

Ceiling power and data feeds kit

Ceiling power and data feeds kit includes a split top trim to facilitate cable entry into the panel, a ceiling grommet, a 16' long electrical cable and power pole featuring a septum to separate power from data cables to avoid electromagnetic interference (EMI). Specify ceiling power pole according to panel width. The ceiling power entry cable must be connected to the building power supply by an electrician. If two power feeds are being specified for one cluster of stations, care must be taken not to cross connect the two feeds through jumper cables and power tracks. The entire power pole accommodates 61 Cat6 and 78 Cat5 cables at a 60% fill capacity if no electrical cable is routed through pole. If electrical is routed within power pole, at a 60% fill capacity, 46 Cat6 and 59 Cat5 cables may be accommodated.

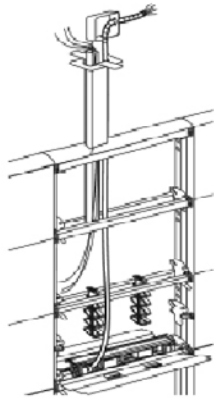

The chimney ceiling feed

The chimney ceiling feed carries up to 99 Cat6 or 128 Cat5 cables from the ceiling into the panel at 60% capacity when electrical is routed within chimney feed as well. If only data is being routed through Chimney Feed 147 Cat6 or 189 Cat5 cables may be routed through the chimney feed. The chimney kit consists of an 18" w Basic frame which includes an internal channel, ceiling collar (white only), and top trim. A septum within the chimney feed separates power and data cables. All tiles and vertical end trim must be specified separately. The 16' power entry cable is optional and is specified by the appropriate code.



Power tracks

Power tracks are specified for frames 30" wide and wider. This power track mounts at the beltline location of a 3 1/2" thick Standard frame by clips that are shipped with the frame. The 30" wide power track accepts one duplex per side. A power track 36" wide and wider accepts two duplexes per side. Power tracks do not include jumper cables. Jumper cables must be specified to carry power from track to track (see Application Guide for length requirements).

Power track kits

Power track kits consist of a power track and clips to attach the power track to a crossrail. The kit allows for power tracks to be mounted in all locations of the 2 3/4" thick panel and in locations other than the beltline location in the 3 1/2" thick standard frames. Jumper cables and receptacles are specified separately. The 30" wide Power Track Kit accepts one duplex per side. Power Track Kits which are 36" wide and wider accept two duplexes per side. Power Track Kits may be specified below the following; Transaction Tops, Up mount Bins, Stack on Glaze, Add on Glaze and Double Glazed Tiles. Power Track Kits MAY NOT be specified below Twin Bins or Power Poles.

Jumper Cables

Jumper cables by-pass non-powered panels and also facilitates connections from power track to power track. Jumper cables must attach to power tracks only and cannot be attached to adjacent jumper cables or power in-feeds. Product codes indicate the width of the jumper cable which may be cross-referenced in the Inscape System Application Guide. Various widths of jumper cables are available to facilitate various applications and configurations. See Inscape System Application Guide for details.

Duplex receptacles

Duplex receptacles snap into power tracks back-to-back and may be accessed through cutouts in either the electrical cover plate with standard frames or multi-access and communication tiles in all other locations and basic frames. Duplexes are interchangeable amongst the varying power track locations. However, specific duplexes are required for various frame thicknesses and Electrified Storage, and need to be specified accordingly. Specify duplexes according to circuit configuration, 2+2 or 3+1. The IN3D3-_ duplex is specific to 2+2 wire configurations and the IN3DU3-_ duplex is specified for 3+1 wire configurations. General rule is no more than 12 receptacles per circuit per power in feed. Duplexes may be specified in black, white (close match to P168 – Glacier White) and gray (close match to P290 – Aluminum Leaf).

Controlled receptacles to satisfy California Title 24 are available. These receptacles control circuits through building switches. When circuits are controlled through building switches, it is required to identify which circuit is controlled to the end user. To identify the receptacles on the controlled circuit, Inscape's controlled receptacles have a power mark (circle with the vertical line). The fit and function of these receptacles are same as the standard receptacle offering only application is in controlled circuits.

USB receptacles are also available. The snap into the standard power track. Each module provides 2 amp output via 2 USB ports and are available for both 2+2 and 3+1 wire configurations. Duplexes may be specified in black, white (close match to P168 – Glacier White) and gray (close match to P290 – Aluminum Leaf).

Task lights

Task lights may be installed below shelf or bin without the need for tools. Horizontal task lights may be adjusted horizontally beneath the bin or shelf. Horizontal task lights are black in color. The LED task light is 20" in length and is silver in color. It is 7.5W and has light color of cool white; 4,500° - 5,500°. The LED task light may be positioned on an overhead bin, shelf or twin bin. When mounted, because of its height of 7/8"h, it is not as visible as other task lights. This task light is magnetic.

Data components

Data hanger bracket

The Data Hanger Bracket provides a place for a voice/data box to be installed within the panel behind the tile (voice/data box not included). The bracket will accommodate up to a 6 outlet faceplate and is packaged in pairs.

Hinged cover (INHRC)

The hinged cover (INHRC) snaps into the cut outs which are found in multi access and communication tiles. When data faceplates and receptacles are not required the hinged cover provides a visual and protective cover.

Fiber optic outlet (INCFO)

Fiber optic outlet (INCFO) is specified to be installed in a cut out in a multi access or communication tile. May be specified in black, white (close match to P168 – Glacier White) and gray (close match to P290 – Aluminum Leaf).

Data and communication faceplate (INCDP)

The data and communication faceplate (INCDP) installs in a cut out in a multi access or communication tile where plug and play access is required. The faceplate provides three “slots” where the Category 5 (INCABRJ45), Category 6 (INCABR6J45), and/or Telephone Jacks (INCRJ11) may be inserted. All “openings” need to be filled with data or phone jacks, The Blank Data Plate Insert (INCB) fills in any which are not being used. Data components may be specified in black, white (close match to P168 – Glacier White) and gray (close match to P290 – Aluminum Leaf). Telephone Jacks (INCRJ11) are not available in gray.

Worksurface grommets

Worksurface grommets are field installed and instructions are available. Inscape cannot and will not be held responsible for the quality of workmanship executed by any installation firm engaged to provide grommet-cutting services required for the field installation of our grommet sleeve/cap offering.

Clamp-on power

Clamp-on power may be clamped along edge of worksurface for plug and play access to electrical/voice/data. Unit has clear anodized aluminum case with white inserts. Different insert configurations available. Voice and data adapter kits are included. Voice and data jacks must be purchased separately. Clamp-on power module has 72” long extension cord. This module adjusts from .75 to 1.75” for varying surface thickness.

Cable hooks

Cable Hooks support and segregate data cables. Each frame 37” and higher ships with one cable manager. Cable hooks carry data cables to their termination voice/data point at a multi access or communication tile for plug and play access or to hanger brackets which are located behind the tile.

Wire management clips

Wire management clips are required when power is being routed from a Credenza Storage benching application frame to the worksurface. Where cabling is running from behind a Credenza Storage case, these wire management clips are mounted to the underside of the inside of the case and the wires are cleanly routed to the main surface. These clips come in a package of 10 and are white in color.

Wire casing

Wire casing manages cables and technology from a worksurface to the floor. Casing is 29” long but can be adjustable in length by removing or adding “links”. Casing is available in gray. As standard the wire casing accommodates 28.5”h worksurface heights. The wire casing accommodates 30 Cat5 cables with electrical works at a 60% fill capacity which is recommended. Approximately 36 Cat5 cables may be accommodated in the wire casing at a 60% fill capacity without electrical works.

Power bar

Power bar is a white power bar consisting of 6 outlets and a 10’ cord which may be specified to provide additional outlets. Addition of power bars should be taken into account when determining the amount of power required for a single or a cluster of stations. The power bar may be mounted under the worksurface.

Electrified storage compliment technology components

Electrified storage compliment technology components have been designed to fit within or compliment the Electrified Storage case. These components essentially work the same as the frame components but are specified based on specific lengths in relation to Electrified Storage.

Electrified storage cable closets

The electrified storage cable closets are designed to facilitate technology entering the Electrified Storage cases if a panel is not present. The cable closet is specified for the end of an Electrified Storage single case or run of cases. The closet is 1 ½” space thick, 18”w and is specified based on the height of the case with which it is mounting to. Technology may enter the cable closet via the floor or ceiling. Specify correct closet for desired application.

When ceiling feed is required, the **Cable Feed Kit** for the cable closet is required to be specified separately based on the ceiling height. Cable closets which attach to the 1 ½” screen are available to allow for technology to enter an Electrified Storage unit when the 1 ½” screen is being utilized which does not carry power. Be sure to specify inline connectors for the connection of this cable closet to the screen. Closets include all hardware to attach to the Electrified Storage case.

Note: Holes are required to be drilled in the case in order to attach cable closet brackets.

Electrical module side cover

Electrical module side cover is specified for the end of an Electrified Storage unit to conceal the technology zone when a panel, screen or cable closet is not specified. This is a value engineered solution for the finishing of an Electrified Storage run. This cover may be painted the same colors as the Electrified Storage cases.

Electrical module front cover

Electrical module front cover come standard with all Electrified Storage base cases; one side with cut out and one side without. When the configuration of an Electrified Storage base unit calls for additional cut outs or no cut outs on the other side of the unit, the appropriate front cover may be specified. The 30” wide front cover only includes one cut out.

General information

- Power in-feed connections consist of an 84" long liquid tight cable and a 45" flex cable connected by a 3" metal coupler and elbow joint to sit between bottom rails
- All electrical components are standard 8 wire configuration

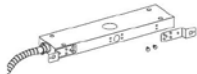
Description	Part number	List Price
 Standard Floor/Wall Power In Feed Kits	INEFWK-8	\$314
 New York City Power In Feed Kit	INEFWK-NY-8	\$558

System

Technology

Power In Feeds



Ceiling Power Pole Kits

General information

- The ceiling power pole accommodates a maximum ceiling height of 11' when placed atop any systems frame height
- See Inscape System Application Guide for compatibility with ceiling heights
- Power pole kit includes top trim, power pole (exposed height noted below) and electrical power in-feed
- "2F" denotes use with 2 ¾" thick frame
"3F" denotes use with 3 ½" thick frame

Notes

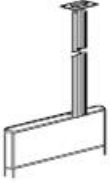
- **Beltline Power Track or Power Track Kit must be located in frame where power pole is entering in order for in-feed to connect**





Description	Part number	Height	Width	Tapered	Flat	Accent paint upcharge	
	Ceiling Power Pole Kit	113"	24"	\$1019	\$1019	+\$103	
	For use with 3 ½" T Frames	INECFK24-8-3F	113"	30"	\$1025	\$1025	+\$103
		INECFK30-8-3F	113"	36"	\$1032	\$1032	+\$104
		INECFK42-8-3F	113"	42"	\$1040	\$1040	+\$105
		INECFK48-8-3F	113"	48"	\$1046	\$1046	+\$105
		INECFK54-8-3F	113"	54"	\$1061	\$1061	+\$107
		INECFK60-8-3F	113"	60"	\$1066	\$1066	+\$107
	Ceiling Power Pole Kit	113"	24"	—	\$1019	+\$103	
	For use with 2 ¾" T Frames	INECFK24-8-2F	113"	30"	—	\$1025	+\$103
		INECFK30-8-2F	113"	36"	—	\$1032	+\$104
		INECFK42-8-2F	113"	42"	—	\$1040	+\$105
		INECFK48-8-2F	113"	48"	—	\$1046	+\$105
		INECFK54-8-2F	113"	54"	—	\$1061	+\$107
		INECFK60-8-2F	113"	60"	—	\$1066	+\$107

General information

- Chimney Feed Kit consists of an 18" w frame and top cap as well as electrical if optioned
- Tiles may span the 18" w Chimney frame along with adjacent frame (see Inscape System Application Guide for acceptable spans)
- "2F" denotes use with 2 3/4" thick frame
- "3F" denotes use with 3 1/2" thick frame
- 96" version is a 64" h frame with additional 27" h stack
- 104" version is a 64" h frame with additional 27" and 13.5" h stack

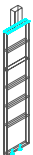
Notes

- Tiles, vertical trim, inline connectors or corner connectors are specified separately
- A Beltline power track or a Power Track Kit must be specified in directly adjacent panel to the Chimney Power Feed Frame
- 96" h Chimney Power Feed Frame to be ordered for ceiling heights of 8' +/- 6"
- 104" h Chimney Power Feed Frame to be ordered for ceiling height of 9' +/- 6"

Description	Part number	Height	Width	Tapered	Flat	Accent paint upcharge
 <p>Chimney Power Feed Frame with Electrical For use with 3 1/2" T Frames</p>	INCF1896E-8-3F INCF18104E-8-3F	96" 104"	18" 18"	\$1515 \$1756	\$1515 \$1756	+\$153 +\$176
 <p>Chimney Power Feed Frame without Electrical For use with 3 1/2" T Frame</p>	INCF1896-8-3F INCF18104-8-3F	96" 104"	18" 18"	\$1474 \$1715	\$1474 \$1715	+\$149 +\$172
 <p>Chimney Power Feed Frame with Electrical For use with 2 3/4" T Frames</p>	INCF1896E-8-2F INCF18104E-8-2F	96" 104"	18" 18"	— —	\$1515 \$1756	+\$153 +\$176
 <p>Chimney Power Feed Frame without Electrical For use with 2 3/4" T Frames</p>	INCF1896-8-2F INCF18104-8-2F	96" 104"	18" 18"	— —	\$1474 \$1715	+\$149 +\$172

System

Technology

Frame Components

Chicago Electrical Components

General information

- City of Chicago bracket for beltline is for 3 ½" thick frame beltline location only
- City of Chicago bracket is compatible with upper deck and base locations in 2 ¾" and 3 ½" thick frames
- "2F" denotes use with 2 ¾" thick frame, "3F" denotes use with 3 ½" thick frame
- Boxes should be sourced through Ental Industries or J&A Sheet both local Chicago suppliers of electrical junction boxes
- Brackets are painted in Eco Black

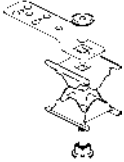
Description	Part number	Height	Width	List price
 City of Chicago Brackets (pkg of 6)	INECHB	—	—	\$77
City of Chicago Bracket for Beltline Location For use with 3 ½" T Standard Frames	INECHB-BL-30-3F	—	30"	\$211
	INECHB-BL-36-3F	—	36"	\$214
	INECHB-BL-42-3F	—	42"	\$216
	INECHB-BL-48-3F	—	48"	\$218
	INECHB-BL-54-3F	—	54"	\$223
	INECHB-BL-60-3F	—	60"	\$228
City of Chicago Bracket for Beltline Location For use with 2 ¾" T Standard Frames	INECHB-BL-30-2F	—	30"	\$211
	INECHB-BL-36-2F	—	36"	\$214
	INECHB-BL-42-2F	—	42"	\$216
	INECHB-BL-48-2F	—	48"	\$218
	INECHB-BL-54-2F	—	54"	\$223
	INECHB-BL-60-2F	—	60"	\$228

General information

- Add beltline cover kit to a Basic Frame to provide power at beltline location (power track separate)
- Cover kits are painted in Eco Black

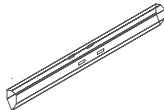
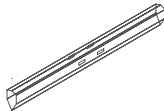
Description	Part number	Height	Width	List price
 <p>Beltline Cover Kit For use with 3 1/2" T Frames</p>	INBCVRKIT-18-3F	6.75"	18"	\$106
	INBCVRKIT-24-3F	6.75"	24"	\$109
	INBCVRKIT-30-3F	6.75"	30"	\$111
	INBCVRKIT-36-3F	6.75"	36"	\$113
	INBCVRKIT-42-3F	6.75"	42"	\$115
	INBCVRKIT-48-3F	6.75"	48"	\$117
	INBCVRKIT-54-3F	6.75"	54"	\$119
 <p>Beltline Cover Kit For use with 2 3/4" T Frames</p>	INBCVRKIT-18-2F	6.75"	18"	\$106
	INBCVRKIT-24-2F	6.75"	24"	\$109
	INBCVRKIT-30-2F	6.75"	30"	\$111
	INBCVRKIT-36-2F	6.75"	36"	\$113
	INBCVRKIT-42-2F	6.75"	42"	\$115
	INBCVRKIT-48-2F	6.75"	48"	\$117
	INBCVRKIT-54-2F	6.75"	54"	\$119
	INBCVRKIT-60-2F	6.75"	60"	\$123

System

Technology Power Tracks

General information

- Specify power tracks for open beltline location in the 3.5" and 2.75" thick standard frames
- Specify Power Track Kit for all locations other than open beltline in 3.5" and 2.75" thick standard frames, where ever a communication or multi access tile is used
- Receptacles and Jumper Cables (track to track connectors) specified separately

Notes

- **Power tracks are required to match the width of the frame it is being installed in**
- **Power Track Kits may be specified below the following; Transaction Tops, Up mount Bins, Stack on Glaze, Add on Glaze and Double Glazed Tiles**
- **Power Track Kits MAY NOT be specified below Twin Bins or Power Poles**

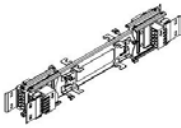
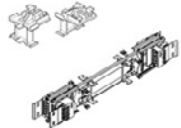
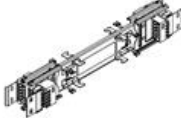
Description	Part number	Width	List price
 <p>Power Track For use with standard frame at beltline only</p>	INETP30-8	30"	\$125
	INETP36-8	36"	\$138
	INETP42-8	42"	\$148
	INETP48-8	48"	\$158
	INETP54-8	54"	\$168
	INETP60-8	60"	\$176
 <p>Power Track Kit For use in all locations on basic frame</p>	INRUDKIT-30-8	30"	\$161
	INRUDKIT-36-8	36"	\$174
	INRUDKIT-42-8	42"	\$190
	INRUDKIT-48-8	48"	\$206
	INRUDKIT-54-8	54"	\$220
	INRUDKIT-60-8	60"	\$236
 <p>Electrified Twin-Bin Power Track</p>	INETPTWB-8	8"	\$75

General information

- Jumper Cables do not connect together nor do they attach to power in feeds
- See Inscope System Application Guide for length requirements for varying panel configurations
- 24" and 25" W jumper cables are made of a black flexible mesh material
- 28" W and larger jumper cables are made of a more rigid metal Conduit material

Description	Part number	Width	List price
 Jumper Cables	INETC24-8	24"	\$62
	INETC25-8	25"	\$62
	INETC28-8	28"	\$62
	INETC31-8	31"	\$64
	INETC44-8	44"	\$67
	INETC53-8	53"	\$75
	INETC64-8	64"	\$90
	INETC88-8	88"	\$117
	INETC104-8	104"	\$134
	INETC122-8	122"	\$166
	INETC141-8	141"	\$167
	INETC158-8	158"	\$184
	INETC182-8	182"	\$211

System

Technology Receptacles

General information

- Receptacles are available in color options of black (default), white and gray
- White close match to 168 Glacier White and Gray close match to 290 – Aluminum Leaf
- Receptacles are specific for frame thickness and location in which they are being specified
- The circuit 3 receptacle requires 2+2 or 3+1 wire designation (“U” in the code signifies 3+1 compatibility)
- The “UD” receptacles are to be specified in conjunction with the Electrified Twin Bin
- Controlled receptacles satisfy California Title 24 and are indicated with a “power mark” which is represented by a circle with a line

Notes

In order to get a total cost on products when upcharges are present take the list price of the product number and add the upcharge cost shown to the list price.

For example:

Product IN3D1-8 in Gray would be \$23 +\$8

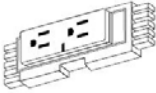
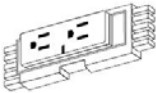
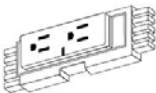
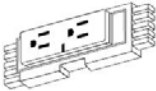
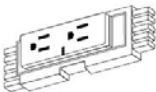
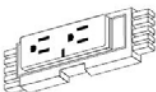
Description	Part number	Black	White	Gray
 <p>Receptacle for open Beltline and Storwal Storage For use in 3 1/2" and 2 3/4" frames</p>	IN3D1-8	\$23	+\$8	+\$8
	IN3D2-8	\$23	+\$8	+\$8
	IN3D3-8	\$23	+\$8	+\$8
	IN3D3U-8	\$23	+\$8	+\$8
	IN3D4-8	\$23	+\$8	+\$8
 <p>Receptacle for cutout tiles application in 3 1/2" frames</p>	IN3D1-UD-8	\$23	+\$8	+\$8
	IN3D2-UD-8	\$23	+\$8	+\$8
	IN3D3-UD-8	\$23	+\$8	+\$8
	IN3D3U-UD-8	\$23	+\$8	+\$8
	IN3D4-UD-8	\$23	+\$8	+\$8
 <p>Receptacle for cutout tiles application in 2 3/4" frames</p>	IN2D1-8	\$23	+\$8	+\$8
	IN2D2-8	\$23	+\$8	+\$8
	IN2D3-8	\$23	+\$8	+\$8
	IN2D3U-8	\$23	+\$8	+\$8
	IN2D4-8	\$23	+\$8	+\$8
 <p>Controlled Receptacle for open Beltline and Storwal Storage For use in 3 1/2" and 2 3/4" frames</p>	IN3D1-8C	\$27	+\$8	+\$8
	IN3D2-8C	\$27	+\$8	+\$8
	IN3D3-8C	\$27	+\$8	+\$8
	IN3D3U-8C	\$27	+\$8	+\$8
	IN3D4-8C	\$27	+\$8	+\$8
 <p>Controlled Receptacle for cutout tiles application in 3 1/2" frames</p>	IN3D1-UD-8C	\$27	+\$8	+\$8
	IN3D2-UD-8C	\$27	+\$8	+\$8
	IN3D3-UD-8C	\$27	+\$8	+\$8
	IN3D3U-UD-8C	\$27	+\$8	+\$8
	IN3D4-UD-8C	\$27	+\$8	+\$8
 <p>Controlled Receptacle for cutout tiles application in 2 3/4" frames</p>	IN2D1-8C	\$27	+\$8	+\$8
	IN2D2-8C	\$27	+\$8	+\$8
	IN2D3-8C	\$27	+\$8	+\$8
	IN2D3U-8C	\$27	+\$8	+\$8
	IN2D4-8C	\$27	+\$8	+\$8

General information

- USB power modules are available in color options of black (default), white and gray
- White close match to 168 Glacier White and Gray close match to 290 – Aluminum Leaf
- USB power modules are specific for frame thickness and location in which they are being specified
- The circuit 3 USB power modules requires 2+2 or 3+1 wire designation (“U” in the code signifies 3+1 compatibility)
- The “UD” USB power modules are to be specified in conjunction with the Electrified Twin Bin

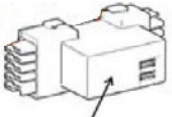
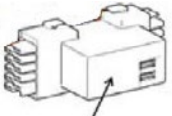
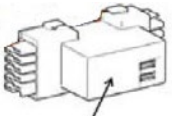
Description	Part number	List price
 <p>USB outlet For use with 2 3/4" T cut out tile</p> <p>USB Charging Module</p>	IN2USB1-8	\$143
	IN2USB2-8	\$143
	IN2USB3-8	\$143
	IN2USB3U-8	\$143
	IN2USB4-8	\$143
 <p>USB outlet For use with 3 1/2" T cut out tile</p> <p>USB Charging Module</p>	IN3USB1-UD-8	\$145
	IN3USB2-UD-8	\$145
	IN3USB3-UD-8	\$145
	IN3USB3U-UD-8	\$145
	IN3USB4-UD-8	\$145
 <p>USB outlet For use in open beltline location</p> <p>USB Charging Module</p>	IN3USB1-8	\$141
	IN3USB2-8	\$141
	IN3USB3-8	\$141
	IN3USB3U-8	\$141
	IN3USB4-8	\$141

System

Technology Task Lights

General information

- Task Lights mount to the underside of Overhead Bins and Shelves
- A power track must be specified in frame to connect task light
- LED task light is magnetic and fits below a Twin Bin and other Overhead Storage

Description	Part number	Height	Width	Weight (lbs)	List price
 LED Magnetic Task Light (silver)	INMAGTL	7/8"	20"	1	\$362

General information

- Data components which are face mounted have optional color of black (default), white or gray
- White close match to 168 Glacier White and Gray close match to 290 Aluminum Leaf
- Data components are industry standard sized AMP product
- If specifying AMP Data Communication Plate, AMP jacks and blank inserts must be specified+
- Data hanger bracket is paint Eco Black and allows for industry standard face data plate mount





Notes

Data cannot be installed directly back to back in a 2 3/4" thick frame application

In order to get a total cost on products when upcharges are present take the list price of the product number and add the upcharge cost shown to the list price.

For example:

Product INHRC in Gray would be \$18 +\$8

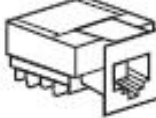
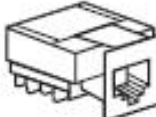
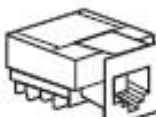
Description	Part number	Weight (lbs)	List price/black	White	Gray
 <p>Data Outlet Hanger Brackets (pair)</p>	INDPMT-W	2	\$41	—	—
 <p>Hinged Cover for Tiles with Cutouts</p>	INHRC	—	\$18	+\$8	+\$8
 <p>Fiber Optic Outlet</p>	INCFO	0.1	\$116	—	—
 <p>Data Communication Plate</p>	INCDP	0.1	\$23	+\$6	+\$6
 <p>Blank Data Plate Insert</p>	INCB	0.1	\$12	+\$5	+\$5
 <p>Telephone Jack</p>	INCRJ11	0.1	\$25	+\$5	—
 <p>Category 5A & 5B, RJ45 Jack</p>	INCABRJ45	0.1	\$39	+\$5	+\$5
 <p>Category 6, RJ45 Jack</p>	INC6ABRJ45	0.1	\$77	+\$14	+\$14

System

Technology

Worksurfaces Technology Components

General information



- Grommets must be field installed
- Round Grommet = 2" diameter
- Rectangular Grommet = 3" x 5.25"
- Clamp on Power Modules have white inserts and a 72" long power cord. It attaches to 1" and 1 ¼" thick worksurfaces
- Flip-up Power & Data Module is finished with a clear anodized aluminum with white inserts and a 72" long power cord

Notes

In order to get a total cost on products when upcharges are present take the list price of the product number and add the upcharge cost shown to the list price.

For example:





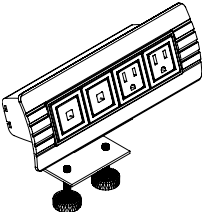
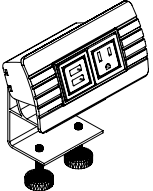
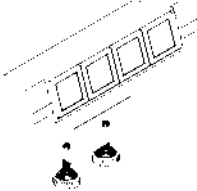
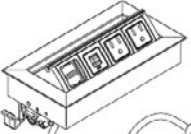

Product PLNGRKIT in Stainless Steel would be +\$0 +\$72

Description	Part number	Dimensions	List price	Black	White	Silver	Stainless steel
 Grommet Sleeve & Cover Kit	PLNGRKIT	5 ¼"	\$180	+\$0	—	—	+\$72
 Worksurface Grommet-PVC Sleeve & CAP	GROMMET-WS	—	\$14	+\$0	—	—	—

Description	Part number	List price
 Clamp-on Power Module 2 receptacles/2 voice/data ports	PVDMODTC	\$452
 Clamp-on Power Module 1 receptacle/1 dual USB port	PVDMODTC-1P1U	\$488
 Clamp-on Power Module 3 receptacle/1 dual USB port	PVDMODTC-3P1U	\$550
 Flip-up Power & Data Module 2 outlets + 1 dual USB + 1 data	PVDMODFL	\$786

General information

- One cable hook is included with each standard frame
- Wire Casing is 29" long and allows for electrical and data cables to neatly be brought from floor into a table – available in gray only, works with 28.5" worksurface heights
- Power bar available in white only
- Cable Management tray is available in two lengths black only and includes mounting hardware
- Wire Management clips are white and attach by double sided tape which is included

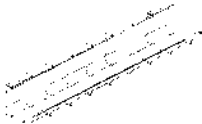
Description	Part number	Width	Weight (lbs)	List price
 Extension Cord for Recessed Duplexes	INEXTCORD-1	12"	—	\$62
 Cable Hooks	INEPWMH	—	0.1	\$14
 Wire Management Clip (pkg of 10)	INWMCLIP	—	—	\$25
 Wire Casing (Gray color)	INFWC	—	—	\$112
 Power Bar (6 outlets, 10' cord)	INPBAR	—	—	\$45
 Cable Management Tray	INCMT18 INCMT30	18" 30"	— —	\$31 \$39
 Wire mesh cable tray (silver)	INWMTRAY	—	—	\$115

System

Technology

Storwal Components

General information

- Receptacles and Jumper Cables (track to track connectors) specified separately
- Jumper Cables do not connect together nor do they attach to power in feeds
- See Inscape System Application Guide for length requirements for varying panel configurations
- 24" and 25" W jumper cables are made of a black flexible mesh material
- 28" W and larger jumper cables are made of a more rigid metal Conduit material
- Receptacles are available in color options of black (default), white and gray
- White close match to 168 Glacier White and Gray close match to 290 – Aluminum Leaf
- The circuit 3 receptacle requires 2+2 or 3+1 wire designation ("U" in the code signifies 3+1 compatibility)





Notes

Power tracks are required to match the width of the storage it is being installed in

In order to get a total cost on products when upcharges are present take the list price of the product number and add the upcharge cost shown to the list price.

For example:

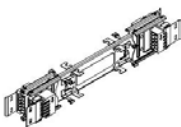

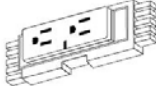

Product IN3D1-8 in Gray would be \$23 +\$8

Description	Part number	Height	Width	List price	Accent paint upcharge
 Storwal Floor/Wall Power In Feed Cable Closet specified separately	INSWEFWK-8	—	—	\$314	—
 Storwal New York City Power In Feed Kit Cable Closet specified separately	INSWEFWK-NY-8	—	—	\$523	—
 Ceiling Power Pole Kit Cable Closet specified separately	INSWECFK-86-8	86"	—	\$453	+\$46
	INSWECFK-96-8	96"	—	\$491	+\$50
	INSWECFK-106-8	106"	—	\$732	+\$75
 Power Track	INETP30-8	—	30"	\$125	—
	INETP36-8	—	36"	\$138	—
	INETP42-8	—	42"	\$148	—
 Jumper Cables	INETC44-8	—	44"	\$67	—
	INETC88-8	—	88"	\$117	—

Description	Part number	Black	White	Gray
 Receptacle for open Beltline and Storwal Storage	IN3D1-8	\$23	+\$8	+\$8
	IN3D2-8	\$23	+\$8	+\$8
	IN3D3-8	\$23	+\$8	+\$8
	IN3D3U-8	\$23	+\$8	+\$8
	IN3D4-8	\$23	+\$8	+\$8

General information

- Ceiling Feed Kit must be specified in conjunction with Cable Closet for Ceiling Feed
- Specific Cable Closet for connection to 1 ½" Screens
- Connection bracket to connect Cable Closet to 2 ¾" or 3 ½" frame included

Description	Part number	Width	Weight (lbs)	List price	Accent paint upcharge
 <p>Cable Closet for Floor/Wall Power In Feed In Feed specified separately</p>	SWCBLCL48	48"	—	\$265	+\$28
	SWCBLCL61.5	61 ½"	—	\$292	+\$30
	SWCBLCL67.5	67 ½"	—	\$303	+\$31
 <p>Cable Closet for Ceiling Power Pole Kit In Feed specified separately</p>	SWCBLCL48-C	48"	—	\$265	+\$28
	SWCBLCL61.5-C	61 ½"	—	\$292	+\$30
	SWCBLCL67.5-C	67 ½"	—	\$303	+\$31
 <p>Cable Closet for Floor/Wall Power In Feed, 1 ½" thick screen In Feed specified separately</p>	SWFFCBLCL48	48"	—	\$265	+\$28
	SWFFCBLCL61.5	61 ½"	—	\$292	+\$30
	SWFFCBLCL67.5	67 ½"	—	\$303	+\$31
 <p>Cable Closet for Ceiling Power Pole Kit, 1 ½" thick screen In Feed specified separately</p>	SWFFCBLCL48-C	48"	—	\$265	+\$28
	SWFFCBLCL61.5-C	61 ½"	—	\$292	+\$30
	SWFFCBLCL67.5-C	67 ½"	—	\$303	+\$31
 <p>Mounting Bracket for Cable Closet for Floor/ Wall Power In Feed , 1 ½" thick screen</p>	SWFFCBLBKT	—	—	\$128	+\$14

System



Technology

Storwal Components

General information

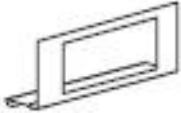
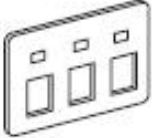
- Data communication plate must be specified in conjunction with Data Bracket
- Electrical Module Side cover, covers the electrical zone between the base and stack unit when no panel or Cable Closet is required at end of run
- Electrical Module Front Cover is ordered based on the width of the case and is installed on site (when ordered separately)

Description	Part number	Width	List price	
	Storwal Chicago Electrical Kit			
	SWCHELKIT-30	30"	\$47	
	SWCHELKIT-36	36"	\$62	
	SWCHELKIT-42	42"	\$78	
	Storwal Data Bracket	SWDB	—	\$21
	Storwal Data Communication Plate	SWCDP	—	\$22

Description	Part number	Width	Neutral paint/ base price	Accent paint upcharge	
	Storwal Electrical Module Side Cover	ECOVER	18"	\$32	+\$5
	Storwal Electrical Module Front Cover with Cutouts				
	EFRCOVER-30	30"	\$50	+\$6	
	EFRCOVER-36	36"	\$50	+\$6	
	EFRCOVER-42	42"	\$50	+\$6	
	Storwal Electrical Module Front Cover without Cutouts				
	EFRCOVER-30-NC	30"	\$39	+\$5	
	EFRCOVER-36-NC	36"	\$39	+\$5	
	EFRCOVER-42-NC	42"	\$39	+\$5	

system

Worksurfaces

Worksurfaces

Panel Mounted Worksurfaces

General information

General information

Depth dimension is nominal. Depths are 1" less than stated to provide a 1" gap between the worksurface and panel to facilitate wire management.

Imperial to Metric Conversions

Inches	mm
18"	457
24"	610
30"	762
36"	914
42"	1067
48"	1219
54"	1372
60"	1524
66"	1676
72"	1829
78"	1981
84"	2134
90"	2286
96"	2438

Electrified storage worksurfaces

Electrified storage worksurface lengths are true size to what is printed in the price list and are 1" less in length than a module line (panel). This allows for a 1" gap between the Electrified Storage unit and the end of the worksurface facilitating wire management and space for the Electrified Storage worksurface support bracket. This 1" less in length also allows the worksurface to line up on-module with a panel. Optional pencil groove is available.

Nuform solid and nuform woodgrain/pattern worksurfaces

The Nuform top is a thermo-formable polymer based sheet continuously bonded to a 1/4" or 1" thick MDF substrate. The polymer sheet is surface coated with a scratch resistant film. Colors are homogenous throughout the film thickness. Top and edge are one continuous surface with no edge seams. The underside of the top is finished in a low pressure melamine. Nuform tops have the option of a pencil groove running across the width of the worksurface as standard and depth for conference tables. Two price options are available - Nuform Solid and Nuform Woodgrain which includes patterns. Limitations exist with the F06, F08, F09, F10, F11, F16, F26 Nuform due to size of the foil - 48" standard and extended corners as well as 120 degree surfaces.

Edge detailed - nuform solid & nuform woodgrain

1 1/4" Straight Edge



1" Straight Edge

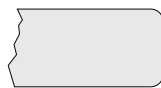

1 1/4" Tapered Edge



1" Tapered Edge



Top and edge are one continuous surface with no edge seams.

Composite veneer worksurfaces

Veneer thickness is 0.025". Overall thickness of top is 1.25". The stain color is impregnated throughout the veneer for color consistency. The open pore veneer is clear coated with a catalyzed lacquer utilizing a multi-step process and has a gloss value of 30° when dry. Tops are constructed utilizing 45lbs density particle board with an engineered balanced backer for structural integrity. Tops are edged in 3mm thick same species veneer and do not include a pencil groove.

Edge detail - composite veneer

Straight Edge



Laminate worksurfaces

Plastic laminate is laminated to 1.25" thick particle-board. The underside of the worksurface is finished with a man-made, wood-fiber veneer backer. Worksurfaces specified with a plastic laminate finish include a 2mm edge banding in a coordinating color. Plastic laminate tops do not include a pencil groove.

All worksurfaces default to 1.25" thick, Straight edge. Pencil Groove is only available on Nuform.

Edge detail - plastic veneer

Straight Edge

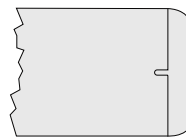

Load capacity for freestanding and panel mounted worksurfaces is 4.5lbs per linear inch.

Grain direction on Nuform Woodgrain and Veneer worksurfaces is as denoted below.

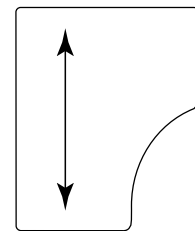
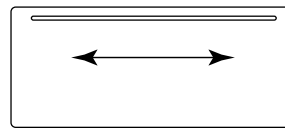

Adjustable height worksurfaces

Adjustable height worksurfaces are available in a panel mounted version which mounts on-module to the Inscape System frame. Worksurfaces provide gas cylinder height adjustment ranging from 28.5" to 49.5" with a lift capacity and calibration of a recommended 25lbs (not including the worksurface). Worksurfaces structured on the height adjustable mechanism are 1" less in stated width in the price list, and are meant to be installed on center to the base allowing for a gap between adjacent surfaces to eliminate pinch points. The base mechanism of the worksurface is available in gray only. See the Inscape System Application Guide for application notes and restrictions.

Product code key example

INW2024

INW	Inscape System worksurface
20	20" deep
24	24" wide

General information

- When manually specifying worksurface of laminate or veneer add suffix "-S" to the code
- Optional pencil groove with Nuform
- To manually specify Nuform worksurfaces; begin with the desired thickness then build up options

- 20"d tops should not be specified with cantilever brackets as mid span support
- 1" thick worksurfaces are not available in laminate or veneer
- Stretcher bars are required to be specified with worksurfaces 54" and wider which do have any mid support- ensure not to interfere with support brackets, cable trays or other work tools

Notes





In order to get a total cost on products when an upcharge or downcharge is present you take the list price of the product number and add the upcharge or deduct the downcharge cost shown to the list price.

For example:

Product INW2024 in Nuform Woodgrain with a tapered edge would be \$205 +\$24 +\$13

Product INW2024 in Nuform Woodgrain with a 1" straight edge would be \$205 +\$24 -\$23

Product INW2024 in veneer would be \$205 +\$507

Description	Part number	Width	Depth	1 1/4" straight edge nuform solid/laminate	Nuform woodgrain/pattern	Nuform tapered edge	1" straight edge nuform solid	Grade 1 laminate <small>1 1/4" straight edge only</small>	Veneer <small>1 1/4" straight edge only</small>
 20" D Rectangular Top	INW2024	24"	20"	\$205	+\$24	+\$13	-\$23	+\$66	+\$507
	INW2030	30"	20"	\$222	+\$26	+\$16	-\$25	+\$72	+\$538
	INW2036	36"	20"	\$251	+\$28	+\$16	-\$27	+\$81	+\$550
	INW2042	42"	20"	\$264	+\$28	+\$17	-\$27	+\$85	+\$587
	INW2048	48"	20"	\$301	+\$32	+\$19	-\$31	+\$97	+\$600
	INW2054	54"	20"	\$337	+\$39	+\$24	-\$33	+\$108	+\$615
	INW2060	60"	20"	\$376	+\$43	+\$26	-\$38	+\$121	+\$642
	INW2066	66"	20"	\$412	+\$45	+\$28	-\$42	+\$132	+\$642
	INW2072	72"	20"	\$451	+\$50	+\$29	-\$44	+\$145	+\$654
	INW2078	78"	20"	\$489	+\$55	+\$31	-\$49	+\$157	+\$667
	INW2084	84"	20"	\$602	+\$61	+\$32	-\$109	+\$193	+\$603
INW2090	90"	20"	\$639	+\$66	+\$36	-\$94	+\$205	+\$619	
INW2096	96"	20"	\$680	+\$74	+\$38	-\$88	+\$218	+\$625	
 24" D Rectangular Top	INW2424	24"	24"	\$254	+\$28	+\$13	-\$27	+\$82	+\$538
	INW2430	30"	24"	\$276	+\$30	+\$16	-\$29	+\$89	+\$567
	INW2436	36"	24"	\$313	+\$33	+\$16	-\$32	+\$101	+\$577
	INW2442	42"	24"	\$328	+\$34	+\$17	-\$33	+\$105	+\$617
	INW2448	48"	24"	\$376	+\$39	+\$19	-\$38	+\$121	+\$628
	INW2454	54"	24"	\$422	+\$45	+\$24	-\$44	+\$136	+\$638
	INW2460	60"	24"	\$468	+\$48	+\$26	-\$47	+\$150	+\$663
	INW2466	66"	24"	\$514	+\$52	+\$28	-\$51	+\$165	+\$658
	INW2472	72"	24"	\$563	+\$58	+\$29	-\$57	+\$181	+\$666
	INW2478	78"	24"	\$611	+\$63	+\$31	-\$62	+\$196	+\$675
	INW2484	84"	24"	\$658	+\$67	+\$32	-\$66	+\$211	+\$682
INW2490	90"	24"	\$707	+\$74	+\$36	-\$73	+\$227	+\$692	
INW2496	96"	24"	\$755	+\$77	+\$38	-\$76	+\$242	+\$693	
 30" D Rectangular Top	INW3024	24"	30"	\$324	+\$34	+\$17	-\$33	+\$104	+\$583
	INW3030	30"	30"	\$341	+\$37	+\$21	-\$36	+\$110	+\$635
	INW3036	36"	30"	\$389	+\$40	+\$22	-\$39	+\$125	+\$662
	INW3042	42"	30"	\$411	+\$43	+\$23	-\$42	+\$132	+\$703
	INW3048	48"	30"	\$468	+\$48	+\$26	-\$47	+\$150	+\$708
	INW3054	54"	30"	\$526	+\$54	+\$27	-\$52	+\$169	+\$717
	INW3060	60"	30"	\$587	+\$60	+\$30	-\$59	+\$188	+\$723
	INW3066	66"	30"	\$627	+\$64	+\$33	-\$63	+\$201	+\$755
	INW3072	72"	30"	\$703	+\$72	+\$34	-\$71	+\$225	+\$737
	INW3078	78"	30"	\$779	+\$78	+\$39	-\$77	+\$250	+\$738
	INW3084	84"	30"	\$854	+\$88	+\$44	-\$86	+\$274	+\$691
INW3090	90"	30"	\$930	+\$96	+\$48	-\$92	+\$298	+\$670	
INW3096	96"	30"	\$1007	+\$103	+\$51	-\$101	+\$323	+\$656	
 36" D Rectangular Top	INW3624	24"	36"	\$375	+\$40	+\$58	-\$40	+\$120	+\$597
	INW3630	30"	36"	\$397	+\$43	+\$62	-\$43	+\$128	+\$652
	INW3636	36"	36"	\$452	+\$47	+\$70	-\$47	+\$145	+\$672
	INW3642	42"	36"	\$477	+\$48	+\$73	-\$48	+\$153	+\$816
	INW3648	48"	36"	\$541	+\$57	+\$83	-\$60	+\$174	+\$843
	INW3654	54"	36"	\$609	+\$63	+\$91	-\$60	+\$195	+\$853
	INW3660	60"	36"	\$682	+\$71	+\$101	-\$71	+\$219	+\$905
INW3666	66"	36"	\$723	+\$74	+\$106	-\$74	+\$232	+\$942	
INW3672	72"	36"	\$814	+\$81	+\$111	-\$80	+\$261	+\$931	

System

Worksurfaces

Panel Mounted Worksurfaces

Reducing Tops

Product code key example

INRDL302430

IN	Inscape System
RD	reducing top
L	left hand
3024	30-24" deep
30	30" wide

General information

- When manually specifying worksurface of laminate or veneer add suffix “-S” to the code
- Optional pencil groove with Nuform
- To manually specify Nuform worksurfaces; begin with the desired thickness then build up options
- 1" thick worksurfaces are not available in laminate or veneer
- Stretcher bars are required to be specified with worksurfaces 54" and wider which do have any mid support– ensure not to interfere with support brackets, cable trays or other work tools



Notes

In order to get a total cost on products when an upcharge or downcharge is present you take the list price of the product number and add the upcharge or deduct the downcharge cost shown to the list price.

For example:

Product INRDL302430 in Nuform Woodgrain with a tapered edge would be \$340 +\$32 +\$18

Product INRDL302430 in Nuform Woodgrain with a 1" straight edge would be \$340 +\$32 -\$31

Description	Part number	Width	Depth	1 ¼" straight edge nuform solid	Nuform woodgrain/pattern	Nuform tapered edge	1" straight edge nuform solid	Veneer 1 ¼" straight edge only
 Left Hand Reducing Top	INRDL302430	30"	30-24"	\$340	+\$32	+\$18	-\$31	—
	INRDL302436	36"	30-24"	\$389	+\$38	+\$21	-\$37	—
	INRDL302442	42"	30-24"	\$411	+\$39	+\$22	-\$38	—
	INRDL302448	48"	30-24"	\$468	+\$44	+\$25	-\$43	—
	INRDL302454	54"	30-24"	\$526	+\$48	+\$27	-\$47	—
	INRDL302460	60"	30-24"	\$587	+\$54	+\$30	-\$52	—
	INRDL302466	66"	30-24"	\$627	+\$58	+\$32	-\$57	—
	INRDL302472	72"	30-24"	\$700	+\$64	+\$35	-\$63	—
	INRDL302478	78"	30-24"	\$735	+\$67	+\$36	-\$64	—
	INRDL302484	84"	30-24"	\$770	+\$74	+\$38	-\$73	—
INRDL302490	90"	30-24"	\$804	+\$73	+\$44	-\$73	—	
INRDL302496	96"	30-24"	\$848	+\$81	+\$45	-\$80	—	
 Right Hand Reducing Top	INRDR243030	30"	24-30"	\$340	+\$32	+\$18	-\$31	—
	INRDR243036	36"	24-30"	\$389	+\$38	+\$21	-\$37	—
	INRDR243042	42"	24-30"	\$411	+\$39	+\$22	-\$38	—
	INRDR243048	48"	24-30"	\$468	+\$44	+\$25	-\$43	—
	INRDR243054	54"	24-30"	\$526	+\$48	+\$27	-\$47	—
	INRDR243060	60"	24-30"	\$587	+\$54	+\$30	-\$52	—
	INRDR243066	66"	24-30"	\$627	+\$58	+\$32	-\$57	—
	INRDR243072	72"	24-30"	\$700	+\$64	+\$35	-\$63	—
	INRDR243078	78"	24-30"	\$735	+\$67	+\$36	-\$64	—
	INRDR243084	84"	24-30"	\$770	+\$74	+\$38	-\$73	—
INRDR243090	90"	24-30"	\$804	+\$73	+\$44	-\$73	—	
INRDR243096	96"	24-30"	\$848	+\$81	+\$45	-\$80	—	

Product code key example

INSD3048

IN	Inscape System worksurface
SD	saddle top
30	30" deep
48	48" wide

General information

- When manually specifying worksurface of laminate or veneer add suffix “-S” to the code
- Optional pencil groove with Nuform
- To manually specify Nuform worksurfaces; begin with the desired thickness then build up options
- 1" thick worksurfaces are not available in laminate or veneer
- Stretcher bars are required to be specified with worksurfaces 54" and wider which do have any mid support– ensure not to interfere with support brackets, cable trays or other work tools

Notes

In order to get a total cost on products when an upcharge or downcharge is present you take the list price of the product number and add the upcharge or deduct the downcharge cost shown to the list price.

For example:

Product INSD3048 in Nuform Woodgrain with a tapered edge would be \$492 +\$50 +\$27

Product INSD3048 in Nuform Woodgrain with a 1" straight edge would be \$492 +\$50 -\$49

Product INSD3048 in veneer would be \$492 +\$744

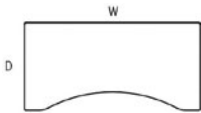
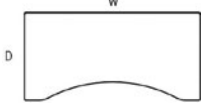
Description	Part number	Width	Depth	1 ¼" straight edge nuform solid/laminate	Nuform woodgrain/pattern	Nuform tapered edge	1" straight edge nuform solid	Grade 1 laminate 1 ¼" straight edge only	Veneer 1 ¼" straight edge only
 30" D Saddle Top	INSD3048	48"	30"	\$492	+\$50	+\$27	-\$49	+\$158	+\$744
	INSD3054	54"	30"	\$552	+\$57	+\$28	-\$55	+\$177	+\$753
	INSD3060	60"	30"	\$616	+\$64	+\$31	-\$63	+\$198	+\$760
	INSD3066	66"	30"	\$656	+\$66	+\$34	-\$65	+\$210	+\$793
	INSD3072	72"	30"	\$738	+\$75	+\$36	-\$74	+\$237	+\$773
	INSD3084	84"	30"	\$886	+\$92	+\$46	-\$80	+\$284	+\$734
	INSD3096	96"	30"	\$1045	+\$108	+\$55	-\$92	+\$335	+\$645
 36" D Saddle Top	INSD3648	48"	36"	\$563	+\$55	+\$28	-\$60	+\$181	+\$846
	INSD3654	54"	36"	\$630	+\$64	+\$32	-\$63	+\$202	+\$858
	INSD3660	60"	36"	\$703	+\$74	+\$35	-\$73	+\$225	+\$865
	INSD3666	66"	36"	\$749	+\$76	+\$38	-\$75	+\$240	+\$905
	INSD3672	72"	36"	\$841	+\$84	+\$42	-\$83	+\$270	+\$883
	INSD3684	84"	36"	\$1038	+\$103	+\$47	-\$92	+\$333	+\$790
	INSD3696	96"	36"	\$1222	+\$120	+\$55	-\$110	+\$392	+\$717

System

Worksurfaces

Panel Mounted Worksurfaces

Galley Tops

Product code key example

INWG362460

INW	Inscape System worksurface
G	galley top
3624	36-24" deep
60	60" wide

General information

- When manually specifying worksurface of laminate or veneer add suffix “-S” to the code
- Optional pencil groove with Nuform
- To manually specify Nuform worksurfaces; begin with the desired thickness then build up options
- 1" thick worksurfaces are not available in laminate or veneer
- Stretcher bars are required to be specified with worksurfaces 54" and wider which do have any mid support– ensure not to interfere with support brackets, cable trays or other work tools

Notes

In order to get a total cost on products when an upcharge or downcharge is present you take the list price of the product number and add the upcharge or deduct the downcharge cost shown to the list price.

For example:

Product INWG362460 in Nuform Woodgrain with a tapered edge would be \$682 +\$71 +\$32

Product INWG362460 in Nuform Woodgrain with a 1" straight edge would be \$682 +\$71 -\$65

Product INWG362460 in veneer would be \$682 +\$1411

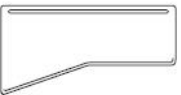
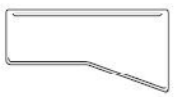
Description	Part number	Width	Depth	1 ¼" straight edge nufrom solid/laminate	Nuform woodgrain/pattern	Nuform tapered edge	1" straight edge nufrom solid	Grade 1 laminate 1 ¼" straight edge only	Veneer 1 ¼" straight edge only
 Left Hand Galley Top	INWG362460	60"	36-24"	\$682	+\$71	+\$32	-\$65	+\$219	+\$1411
	INWG362466	66"	36-24"	\$733	+\$75	+\$35	-\$74	+\$235	+\$1470
	INWG362472	72"	36-24"	\$814	+\$82	+\$40	-\$81	+\$261	+\$1482
	INWG362478	78"	36-24"	\$902	+\$91	+\$46	-\$89	+\$289	+\$1487
	INWG362484	84"	36-24"	\$991	+\$102	+\$50	-\$100	+\$318	+\$1502
	INWG362490	90"	36-24"	\$1020	+\$103	+\$55	-\$101	+\$327	+\$1575
	INWG362496	96"	36-24"	\$1070	+\$108	+\$59	-\$106	+\$343	+\$1624
 Right Hand Galley Top	INWG243660	60"	24-36"	\$682	+\$71	+\$32	-\$65	+\$219	+\$1411
	INWG243666	66"	24-36"	\$733	+\$75	+\$35	-\$74	+\$235	+\$1470
	INWG243672	72"	24-36"	\$814	+\$82	+\$40	-\$81	+\$261	+\$1482
	INWG243678	78"	24-36"	\$902	+\$91	+\$46	-\$89	+\$289	+\$1487
	INWG243684	84"	24-36"	\$991	+\$102	+\$50	-\$100	+\$318	+\$1502
	INWG243690	90"	24-36"	\$1020	+\$103	+\$55	-\$101	+\$327	+\$1575
	INWG243696	96"	24-36"	\$1070	+\$108	+\$59	-\$106	+\$343	+\$1624

Product code key example

INWF304272

INW Inscape System worksurface
F funnel top
3042 30-42" deep
72 72" wide

General information

- When manually specifying worksurface of laminate or veneer add suffix “-S” to the code
- Optional pencil groove with Nuform
- To manually specify Nuform worksurfaces; begin with the desired thickness then build up options
- 20”d tops should not be specified with cantilever brackets as mid span support
- Stretcher bars are required to be specified with worksurfaces 54” and wider which do have any mid support– ensure not to interfere with support brackets, cable trays or other work tools

Notes

In order to get a total cost on products when an upcharge or downcharge is present you take the list price of the product number and add the upcharge or deduct the downcharge cost shown to the list price.

For example:

Product INWF304272 in Nuform Woodgrain with a tapered edge would be \$884 +\$90 +\$44

Product INWF304272 in Nuform Woodgrain with a 1” straight edge would be \$884 +\$90 -\$88

Product INWF304272 in veneer would be \$884 +\$1283

Description	Part number	Width	Depth	1 ¼" straight edge nuform solid/laminate	Nuform woodgrain/pattern	Nuform tapered edge	1" straight edge nuform solid	Grade 1 laminate 1 ¼" straight edge only	Veneer 1 ¼" straight edge only
	INWF304272	72"	30-42"	\$884	+\$90	+\$44	-\$88	+\$283	+\$1283
	INWF304278	78"	30-42"	\$980	+\$100	+\$48	-\$98	+\$314	+\$1268
	INWF304284	84"	30-42"	\$1075	+\$110	+\$54	-\$108	+\$344	+\$1363
	INWF304290	90"	30-42"	\$1108	+\$111	+\$55	-\$111	+\$355	+\$1547
	INWF304296	96"	30-42"	\$1164	+\$117	+\$58	-\$115	+\$373	+\$1631

Funnel Top

System

Worksurfaces

Panel Mounted Worksurfaces

Radiused Tops

Product code key example

INRER2460

INRE	Inscape System radiused top
24	24" deep
60	60" wide

General information

- When manually specifying worksurface of laminate or veneer add suffix “-S” to the code
- Optional pencil groove with Nuform
- To manually specify Nuform worksurfaces; begin with the desired thickness then build up options
- 1" thick worksurfaces are not available in laminate or veneer
- Stretcher bars are required to be specified with worksurfaces 54" and wider which do have any mid support– ensure not to interfere with support brackets, cable trays or other work tools

Notes

In order to get a total cost on products when an upcharge or downcharge is present you take the list price of the product number and add the upcharge or deduct the downcharge cost shown to the list price.

For example:

Product INRER2460 in Nuform Woodgrain with a tapered edge would be \$466 +\$48 +\$25

Product INRER2460 in Nuform Woodgrain with a 1" straight edge would be \$466 +\$48 -\$47

Product INRER2460 in veneer would be \$466 +\$1393

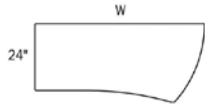
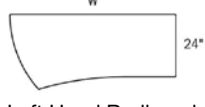
Description	Part number	Width	Depth	1 ¼" straight edge nuform solid/laminate	Nuform woodgrain/pattern	Nuform tapered edge	1" straight edge nuform solid	Grade 1 laminate 1 ¼" straight edge only	Veneer 1 ¼" straight edge only
 Right Hand Radiused End Top	INRER2460	60"	24"	\$466	+\$48	+\$25	-\$47	+\$150	+\$1393
	INRER2466	66"	24"	\$498	+\$50	+\$26	-\$49	+\$160	+\$1437
	INRER2472	72"	24"	\$560	+\$57	+\$28	-\$55	+\$180	+\$1459
	INRER2478	78"	24"	\$682	+\$71	+\$36	-\$70	+\$219	+\$1553
	INRER2484	84"	24"	\$824	+\$84	+\$47	-\$83	+\$264	+\$1881
	INRER2490	90"	24"	\$892	+\$88	+\$50	-\$88	+\$286	+\$2295
INRER2496	96"	24"	\$959	+\$96	+\$55	-\$96	+\$307	+\$2611	
 Left Hand Radiused End Top	INREL2460	60"	24"	\$466	+\$48	+\$25	-\$47	+\$150	+\$1393
	INREL2466	66"	24"	\$498	+\$50	+\$26	-\$49	+\$160	+\$1437
	INREL2472	72"	24"	\$560	+\$57	+\$28	-\$55	+\$180	+\$1459
	INREL2478	78"	24"	\$682	+\$71	+\$36	-\$70	+\$219	+\$1553
	INREL2484	84"	24"	\$824	+\$84	+\$47	-\$83	+\$264	+\$1881
	INREL2490	90"	24"	\$892	+\$88	+\$50	-\$88	+\$286	+\$2295
INREL2496	96"	24"	\$959	+\$96	+\$55	-\$96	+\$307	+\$2611	

Product code key example

INCR3636-22

INCR	Inscape System standard corner
3636	36 x 36" wide
22	24" depth

General information

- When manually specifying worksurface of laminate or veneer add suffix "-S" to the code
- Optional pencil groove with Nuform
- To manually specify Nuform worksurfaces; begin with the desired thickness then build up options
- 48" Split Corner accommodates 24" or 30" returns
- Standard Corner and Split Corner include a

radius front edge

- Limitations exist with the F06, F08, F09, F10, F11, F16, F26 Nuform due to size of the foil – 48" standard and extended corners as well as 120 degree surfaces
- 1" thick worksurfaces are not available in laminate or veneer
- Stretcher bars are required to be specified with worksurfaces 54" and wider which do have any mid support– ensure not to interfere with support brackets, cable trays or other work tools

Notes

In order to get a total cost on products when an upcharge or downcharge is present you take the list price of the product number and add the upcharge or deduct the downcharge cost shown to the list price.

For example:

Product INCR3636-22 in Nuform Woodgrain with a tapered edge would be \$439 +\$44 +\$24

Product INCR3636-22 in Nuform Woodgrain with a 1" straight edge would be \$439 +\$44 -\$43

Product INCR3636-22 in veneer would be \$439 +\$1034

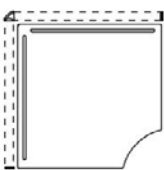
Description	Part number	Width	Depth	1 ¼" straight edge nuform solid/laminate	Nuform woodgrain/pattern	Nuform tapered edge	1" straight edge nuform solid	Grade 1 laminate 1 ¼" straight edge only	Veneer 1 ¼" straight edge only
	INCR3636-22	36"	24"	\$439	+\$44	+\$24	-\$43	+\$141	+\$1034
	INCR4242-22	42"	24"	\$626	+\$64	+\$32	-\$63	+\$201	+\$1075
	INCR4848-22	48"	24"	\$763	+\$76	+\$39	-\$70	+\$245	+\$1217

Standard Corners 24" returns

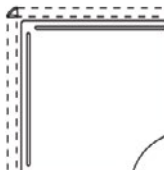
	INCR4242-33	42"	30"	\$626	+\$64	+\$32	-\$63	+\$201	+\$1164
	INCR4848-33	48"	30"	\$763	+\$76	+\$39	-\$70	+\$245	+\$1217

Standard Corners 30" returns

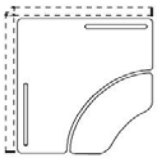
	INCSLS4242-22	42"	24"	\$1348	+\$55	—	-\$54	+\$432	—
	INCSLS4848	48"	24 or 30"	\$1492	+\$60	—	-\$59	+\$478	—

Split Corners

System

Worksurfaces

Panel Mounted Worksurfaces

Extended Corners

Product code key example

INECR6036-22

IN	Inscape System
ECR	Extended corner worksurfaces
60	60" long
36	36" wide
-22	24" deep returns on both ends

General information

- Extended Corners accommodate 24" deep returns
- When manually specifying worksurface of laminate or veneer add suffix "-S" to the code

- Optional pencil groove with Nuform
- To manually specify Nuform worksurfaces; begin with thickness then build up options
- Limitations exist with the F06, F08, F09, F10, F11, F16, F26 Nuform due to size of the foil – 48" standard and extended corners as well as 120 degree surfaces
- 1" thick worksurfaces are not available in laminate or veneer
- Stretcher bars are required to be specified with worksurfaces 54" and wider which do have any mid support– ensure not to interfere with support brackets, cable trays or other work tools

Notes

In order to get a total cost on products when an upcharge or downcharge is present you take the list price of the product number and add the upcharge or deduct the downcharge cost shown to the list price.

For example:

Product INECR6036-22 in Nuform Woodgrain with a tapered edge would be \$719 +\$73 +\$37

Product INECR6036-22 in Nuform Woodgrain with a 1" straight edge would be \$719 +\$73 -\$72

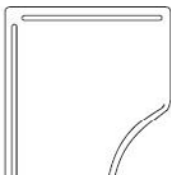
Description	Part number	Width	Depth	1 ¼" straight edge nuform solid/laminate	Nuform woodgrain/pattern	Nuform tapered edge	1" straight edge nuform solid	Grade 1 laminate 1 ¼" straight edge only	Veneer 1 ¼" straight edge only
	INECR6036-22	60"	24"	\$719	+\$73	+\$37	-\$72	+\$231	—
	INECR6636-22	66"	24"	\$734	+\$76	+\$37	-\$75	+\$235	—
	INECR7236-22	72"	24"	\$748	+\$77	+\$39	-\$76	+\$240	—
	INECR7836-22	78"	24"	\$763	+\$78	+\$39	-\$77	+\$245	—
	INECR8436-22	84"	24"	\$781	+\$79	+\$40	-\$78	+\$250	—
	INECR9036-22	90"	24"	\$797	+\$81	+\$40	-\$80	+\$256	—
	INECR9636-22	96"	24"	\$812	+\$81	+\$42	-\$80	+\$260	—

36" Left Hand
Extended Corners

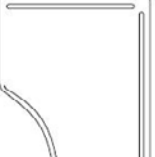
	INECR3660-22	60"	24"	\$719	+\$73	+\$37	-\$72	+\$231	—
	INECR3666-22	66"	24"	\$734	+\$76	+\$37	-\$75	+\$235	—
	INECR3672-22	72"	24"	\$748	+\$77	+\$39	-\$76	+\$240	—
	INECR3678-22	78"	24"	\$763	+\$78	+\$39	-\$77	+\$245	—
	INECR3684-22	84"	24"	\$781	+\$79	+\$40	-\$78	+\$250	—
	INECR3690-22	90"	24"	\$797	+\$81	+\$40	-\$80	+\$256	—
	INECR3696-22	96"	24"	\$812	+\$81	+\$42	-\$80	+\$260	—

36" Right Hand
Extended Corners

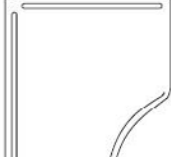
	INECR6042-22	60"	24"	\$757	+\$76	+\$38	-\$75	+\$243	—
	INECR6642-22	66"	24"	\$771	+\$78	+\$38	-\$77	+\$247	—
	INECR7242-22	72"	24"	\$788	+\$79	+\$39	-\$78	+\$253	—
	INECR7842-22	78"	24"	\$804	+\$81	+\$40	-\$80	+\$258	—
	INECR8442-22	84"	24"	\$822	+\$82	+\$40	-\$81	+\$264	—
	INECR9042-22	90"	24"	\$838	+\$83	+\$43	-\$83	+\$269	—
	INECR9642-22	96"	24"	\$854	+\$88	+\$44	-\$86	+\$274	—

42" Left Hand
Extended Corners

	INECR4260-22	60"	24"	\$757	+\$76	+\$38	-\$75	+\$243	—
	INECR4266-22	66"	24"	\$771	+\$78	+\$38	-\$77	+\$247	—
	INECR4272-22	72"	24"	\$788	+\$79	+\$39	-\$78	+\$253	—
	INECR4278-22	78"	24"	\$804	+\$81	+\$40	-\$80	+\$258	—
	INECR4284-22	84"	24"	\$822	+\$82	+\$40	-\$81	+\$264	—
	INECR4290-22	90"	24"	\$838	+\$83	+\$43	-\$83	+\$269	—
	INECR4296-22	96"	24"	\$854	+\$88	+\$44	-\$86	+\$274	—

42" Right Hand
Extended Corners

Product code key example

INECR6036-33

IN	Inscape System
ECR	Extended corner worksurfaces
60	60" long
36	36" wide
-33	30" deep returns on both ends

General information

- Extended Corners accommodate 30" deep returns
- When manually specifying worksurface of laminate or veneer add suffix "-S" to the code

- Optional pencil groove with Nuform
- To manually specify Nuform worksurfaces; begin with thickness then build up options
- Limitations exist with the F06, F08, F09, F10, F11, F16, F26 Nuform due to size of the foil – 48" standard and extended corners as well as 120 degree surfaces
- 1" thick worksurfaces are not available in laminate or veneer
- Stretcher bars are required to be specified with worksurfaces 54" and wider which do have any mid support– ensure not to interfere with support brackets, cable trays or other work tools

Notes

In order to get a total cost on products when an upcharge or downcharge is present you take the list price of the product number and add the upcharge or deduct the downcharge cost shown to the list price.

For example:

Product INECR6042-33 in Nuform Woodgrain with a tapered edge would be \$886 +\$90 +\$44

Product INECR6042-33 in Nuform Woodgrain with a 1" straight edge would be \$886 +\$90 -\$88

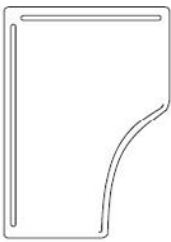
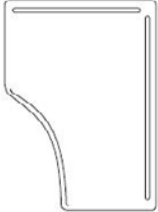
Description	Part number	Width	Depth	1 ¼" straight edge nuform solid/laminate	Nuform woodgrain/pattern	Nuform tapered edge	1" straight edge nuform solid	Grade 1 laminate 1 ¼" straight edge only	Veneer 1 ¼" straight edge only
	INECR6042-33	60"	30"	\$886	+\$90	+\$44	-\$88	+\$284	—
	INECR6642-33	66"	30"	\$904	+\$94	+\$47	-\$91	+\$290	—
	INECR7242-33	72"	30"	\$923	+\$94	+\$47	-\$91	+\$296	—
	INECR7842-33	78"	30"	\$992	+\$101	+\$49	-\$99	+\$318	—
	INECR8442-33	84"	30"	\$1011	+\$153	+\$62	-\$99	+\$324	—
	INECR9042-33	90"	30"	\$1053	+\$162	+\$62	-\$99	+\$337	—
	INECR9642-33	96"	30"	\$1078	+\$170	+\$62	-\$97	+\$345	—
42" Left Hand Extended Corners									
	INECR4260-33	60"	30"	\$886	+\$90	+\$44	-\$88	+\$284	—
	INECR4266-33	66"	30"	\$904	+\$94	+\$47	-\$91	+\$290	—
	INECR4272-33	72"	30"	\$923	+\$94	+\$47	-\$91	+\$296	—
	INECR4278-33	78"	30"	\$992	+\$101	+\$49	-\$99	+\$318	—
	INECR4284-33	84"	30"	\$1011	+\$153	+\$62	-\$99	+\$324	—
	INECR4290-33	90"	30"	\$1053	+\$162	+\$62	-\$99	+\$337	—
	INECR4296-33	96"	30"	\$1078	+\$170	+\$62	-\$97	+\$345	—
42" Right Hand Extended Corners									

System

Worksurfaces

Panel Mounted Worksurfaces

120° Corners

Product code key example

INCRV3636-3F

IN Inscape System
CRV 120 corner worksurfaces
3636 36" x 36" wide
3F 3 1/2" thick frame application

General information

- 120° worksurfaces accommodate 24"d returns on either side
- "2F" denotes use with 2 3/4" thick frame, "3F" denotes use with 3 1/2" thick frame
- When manually specifying worksurface of laminate or veneer add suffix "-S" to the code

- Optional pencil groove with Nuform
- To manually specify Nuform worksurfaces; begin with the desired thickness then build up options
- Limitations exist with the F06, F08, F09, F10, F11, F16, F26 Nuform due to size of the foil – 48" standard and extended corners as well as 120 degree surfaces
- 1" thick worksurfaces are not available in laminate or veneer
- Stretcher bars are required to be specified with worksurfaces 54" and wider which do have any mid support– ensure not to interfere with support brackets, cable trays or other work tools

Notes

In order to get a total cost on products when an upcharge or downcharge is present you take the list price of the product number and add the upcharge or deduct the downcharge cost shown to the list price.

For example:

Product INCRV3636-2F in Nuform Woodgrain with a tapered edge would be \$469 +\$46 +\$26

Product INCRV3636-2F in Nuform Woodgrain with a 1" straight edge would be \$469 +\$46 -\$45

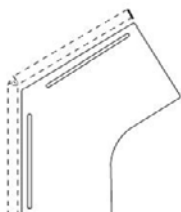
Description	Part number	Width	Depth	1 1/4" straight edge nuform solid/laminate	Nuform woodgrain/pattern	Nuform tapered edge	1" straight edge nuform solid	Grade 1 laminate 1 1/4" straight edge only	Veneer 1 1/4" straight edge only
	INCRV3636-3F	36"	24"	\$469	+\$46	+\$26	-\$45	+\$151	—
	INCRV4242-3F	42"	24"	\$668	+\$67	+\$35	-\$66	+\$214	—
	INCRV4848-3F	48"	24"	\$818	+\$81	+\$40	-\$80	+\$262	—

120° Corner Worksurfaces

For use with 3 1/2" T Frames

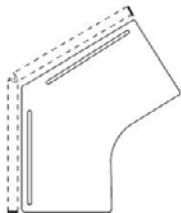
	INCRV3636-2F	36"	24"	\$469	+\$46	+\$26	-\$45	+\$151	—
	INCRV4242-2F	42"	24"	\$668	+\$67	+\$35	-\$66	+\$214	—
	INCRV4848-2F	48"	24"	\$818	+\$81	+\$40	-\$80	+\$262	—

120° Corner Worksurfaces

For use with 2 3/4" T Frames

Product code key example

INCTR3060

IN Inscape System
CTR Conference top
30 30" deep
60 60" wide

General information

- 1" less in width to provide 1" gap between worksurface and panel
- When manually specifying worksurface of laminate or veneer add suffix "-S" to the code
- Optional pencil groove with Nuform

- To manually specify Nuform worksurfaces; begin with the desired thickness then build up options
- Support brackets to panel and leg specified separately
- 1" thick worksurfaces are not available in laminate or veneer
- Stretcher bars are required to be specified with worksurfaces 54" and wider which do have any mid support- ensure not to interfere with support brackets, cable trays or other work tools





Notes

In order to get a total cost on products when an upcharge or downcharge is present you take the list price of the product number and add the upcharge or deduct the downcharge cost shown to the list price.

For example:

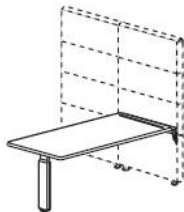
Product INCTR3060 in Nuform Woodgrain would be \$717 +\$75

Product INCTR3060 in Nuform Woodgrain with a 1" straight edge would be \$717 +\$75 -\$74

Description	Part number	Width	Depth	1 ¼" straight edge nuform solid/laminate	Nuform woodgrain/pattern	Nuform tapered edge	1" straight edge nuform solid	Grade 1 laminate 1 ¼" straight edge only	Veneer 1 ¼" straight edge only
 <p>Rectangular Top Top only</p>	INCTR3060	60 (59)"	30"	\$717	+\$75	—	-\$74	+\$230	—
	INCTR3066	66 (65)"	30"	\$763	+\$78	—	-\$77	+\$245	—
	INCTR3072	72 (71)"	30"	\$848	+\$81	—	-\$44	+\$272	—
	INCTR3078	78 (77)"	30"	\$952	+\$97	—	-\$94	+\$305	—
 <p>Bullet Top Top only</p>	INCTB3060	60 (59)"	30"	\$717	+\$75	—	-\$74	+\$230	+\$893
	INCTB3066	66 (65)"	30"	\$764	+\$78	—	-\$77	+\$245	+\$889
	INCTB3072	72 (71)"	30"	\$850	+\$86	—	-\$65	+\$272	+\$865
	INCTB3078	78 (77)"	30"	\$952	+\$97	—	-\$94	+\$305	+\$794
 <p>Left Hand P Shaped Top Top only</p>	INCTCL3060	60 (59)"	30"	\$753	+\$79	—	-\$78	+\$241	—
	INCTCL3066	66 (65)"	30"	\$803	+\$82	—	-\$81	+\$257	—
	INCTCL3072	72 (71)"	30"	\$895	+\$90	—	-\$88	+\$287	—
	INCTCL3078	78 (77)"	30"	\$1001	+\$101	—	-\$99	+\$321	—
 <p>Right Hand P Shaped Top Top only</p>	INCTCR3060	60 (59)"	30"	\$753	+\$79	—	-\$78	+\$241	—
	INCTCR3066	66 (65)"	30"	\$803	+\$82	—	-\$81	+\$257	—
	INCTCR3072	72 (71)"	30"	\$895	+\$90	—	-\$88	+\$287	—
	INCTCR3078	78 (77)"	30"	\$1001	+\$101	—	-\$99	+\$321	—

System

Worksurfaces

Panel Mounted Worksurfaces

Height Adjustable Worksurfaces

Product code key example

INEZ2436

IN Inscape System worksurfaces
EZ Panel mounted height adjustable
24 24" deep
36 36" wide

General information

- The Inscape System Application Guide should be referenced for limitations in the installation of the pneumatic panel mounted height adjustable worksurface
- This manual pneumatic height adjustable table has a lift capacity of 25lbs (includes worksurface)
- Worksurfaces are structured with appropriate weight allotments dialed in to the gas cylinders; height adjustable mechanisms shall be installed with properly structured tops as outlined below
- Height adjustment is 28.5" to 48.5"; a total range of 20"

- Base comes in silver only
- Tops are adjustable by a paddle in the front right of the worksurface
- Worksurfaces are 1" less in width on both sides of worksurface to avoid pinch points (2")
- Recommended load 0-25lbs (does not include worksurface)
- Stretcher bars are included in desks of 60" and wider
- The Panel Stabilizer Bracket ensures the panel which the mechanism is being mounted to is stable in specific conditions. Refer to the Application Guide for specific details (at least one wing panel must be adjacent to the panel mounted height adjustable surface)
- When manually specifying worksurface of laminate or veneer add suffix "-S" to the code
- Optional pencil groove with Nuform
- To manually specify Nuform worksurfaces; begin with the desired thickness then build up options
- 1" thick worksurfaces are not available in laminate or veneer

Notes

In order to get a total cost on products when an upcharge or downcharge is present you take the list price of the product number and add the upcharge or deduct the downcharge cost shown to the list price.

For example:

Product INEZ2436 in Nuform Woodgrain with a tapered edge would be \$1788 +\$33 +\$16

Product INEZ2436 in Nuform Woodgrain with a 1" straight edge would be \$1788 +\$33 -\$32

Product INEZ2436 in veneer would be \$1788 +\$577

Description	Part number	Width	Depth	1 1/4" straight edge nuform solid/laminate	Nuform woodgrain/pattern	Nuform tapered edge	1" straight edge nuform solid	Grade 1 laminate 1 1/4" straight edge only	Veneer 1 1/4" straight edge only
	INEZ2436	36"	24"	\$1788	+\$33	+\$16	-\$32	+\$573	+\$577
	INEZ2442	42"	24"	\$1803	+\$34	+\$17	-\$33	+\$577	+\$617
	INEZ2448	48"	24"	\$1850	+\$39	+\$19	-\$38	+\$592	+\$628
	INEZ2454	54"	24"	\$1897	+\$45	+\$24	-\$44	+\$608	+\$638
	INEZ2460	60"	24"	\$2055	+\$48	+\$26	-\$47	+\$658	+\$663
	INEZ2466	66"	24"	\$2332	+\$52	+\$28	-\$51	+\$747	+\$658
	INEZ2472	72"	24"	\$2394	+\$58	+\$29	-\$57	+\$767	+\$666

24" D Panel Mounted Height Adjustable Worksurface

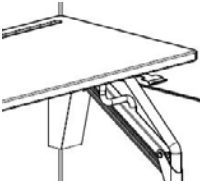
	INEZ3036	36"	30"	\$1864	+\$40	+\$22	-\$39	+\$597	+\$662
	INEZ3042	42"	30"	\$1886	+\$43	+\$23	-\$42	+\$604	+\$703
	INEZ3048	48"	30"	\$2174	+\$48	+\$26	-\$47	+\$696	+\$708
	INEZ3054	54"	30"	\$2231	+\$54	+\$27	-\$52	+\$714	+\$717
	INEZ3060	60"	30"	\$2406	+\$60	+\$30	-\$59	+\$770	+\$723
	INEZ3066	66"	30"	\$2444	+\$64	+\$33	-\$63	+\$783	+\$755
	INEZ3072	72"	30"	\$2533	+\$72	+\$34	-\$71	+\$811	+\$737

30" D Panel Mounted Height Adjustable Worksurface

Description	Part number	Weight (lbs)	Neutral paint/base price	Accent paint upcharge
	INRHPSB12 left hand (illustrated)	—	\$180	+\$19
	INLHPSB12 right hand	—	\$180	+\$19

Product code key example

INSWW2423

IN Inscape System
SWW Storwal worksurface
24 24" deep
23 23" wide

General information

- Storwal worksurfaces are 1" less in length than standard worksurfaces
- When manually specifying worksurface of laminate or veneer add suffix "-S" to the code
- Optional pencil groove with Nuform
- To manually specify Nuform worksurfaces; begin with the desired thickness then build up options
- 1" thick worksurfaces are not available in laminate or veneer
- Stretcher bars are required to be specified with worksurfaces 54" and wider which do have any mid support- ensure not to interfere with support brackets, cable trays or other work tools

Notes



In order to get a total cost on products when an upcharge or downcharge is present you take the list price of the product number and add the upcharge or deduct the downcharge cost shown to the list price.

For example:

Product INSWW2423 in Nuform Woodgrain with a tapered edge would be \$254 +\$28 +\$13

Product INSWW2423 in Nuform Woodgrain with a 1" straight edge would be \$254 +\$28 -\$27

Product INSWW2423 in veneer would be \$254 +\$538

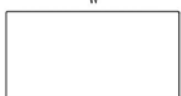
Description	Part number	Width	Depth	1 1/4" straight edge nuform solid/laminate	Nuform woodgrain/pattern	Nuform tapered edge	1" straight edge nuform solid	Grade 1 laminate 1 1/4" straight edge only	Veneer 1 1/4" straight edge only
 <p>24" D Storwal Rectangular Top</p>	INSWW2423	23"	24"	\$254	+\$28	+\$13	-\$27	+\$82	+\$538
	INSWW2429	29"	24"	\$276	+\$30	+\$16	-\$29	+\$89	+\$567
	INSWW2435	35"	24"	\$313	+\$33	+\$16	-\$32	+\$101	+\$577
	INSWW2441	41"	24"	\$328	+\$34	+\$17	-\$33	+\$105	+\$617
	INSWW2447	47"	24"	\$376	+\$39	+\$19	-\$38	+\$121	+\$628
	INSWW2453	53"	24"	\$422	+\$45	+\$24	-\$44	+\$136	+\$638
	INSWW2459	59"	24"	\$468	+\$48	+\$26	-\$47	+\$150	+\$663
	INSWW2465	65"	24"	\$514	+\$52	+\$28	-\$51	+\$165	+\$658
	INSWW2471	71"	24"	\$563	+\$58	+\$29	-\$57	+\$181	+\$666
	INSWW2477	77"	24"	\$611	+\$63	+\$31	-\$62	+\$196	+\$675
	INSWW2483	83"	24"	\$658	+\$67	+\$32	-\$66	+\$211	+\$682
INSWW2489	89"	24"	\$707	+\$74	+\$36	-\$73	+\$227	+\$692	
INSWW2495	95"	24"	\$755	+\$77	+\$38	-\$76	+\$242	+\$693	
 <p>30" D Storwal Rectangular Top</p>	INSWW3023	23"	30"	\$324	+\$34	+\$17	-\$33	+\$104	+\$583
	INSWW3029	29"	30"	\$341	+\$37	+\$21	-\$36	+\$110	+\$635
	INSWW3035	35"	30"	\$389	+\$40	+\$22	-\$39	+\$125	+\$662
	INSWW3041	41"	30"	\$411	+\$43	+\$23	-\$42	+\$132	+\$703
	INSWW3047	47"	30"	\$468	+\$48	+\$26	-\$47	+\$150	+\$708
	INSWW3053	53"	30"	\$526	+\$54	+\$27	-\$52	+\$169	+\$717
	INSWW3059	59"	30"	\$587	+\$60	+\$30	-\$59	+\$188	+\$723
	INSWW3065	65"	30"	\$627	+\$64	+\$33	-\$63	+\$201	+\$755
	INSWW3071	71"	30"	\$703	+\$72	+\$34	-\$71	+\$225	+\$737
	INSWW3077	77"	30"	\$779	+\$78	+\$39	-\$77	+\$250	+\$738
	INSWW3083	83"	30"	\$854	+\$88	+\$44	-\$86	+\$274	+\$691
INSWW3089	89"	30"	\$930	+\$96	+\$48	-\$92	+\$298	+\$670	
INSWW3095	95"	30"	\$1007	+\$103	+\$51	-\$101	+\$323	+\$656	
 <p>36" D Storwal Rectangular Top</p>	INSWW3623	23"	36"	\$375	+\$40	+\$58	-\$40	+\$120	+\$597
	INSWW3629	29"	36"	\$397	+\$43	+\$62	-\$43	+\$128	+\$652
	INSWW3635	35"	36"	\$452	+\$47	+\$70	-\$47	+\$145	+\$672
	INSWW3641	41"	36"	\$477	+\$48	+\$73	-\$48	+\$153	+\$816
	INSWW3647	47"	36"	\$541	+\$57	+\$83	-\$60	+\$174	+\$843
	INSWW3653	53"	36"	\$609	+\$63	+\$91	-\$63	+\$195	+\$853
	INSWW3659	59"	36"	\$682	+\$71	+\$101	-\$71	+\$219	+\$905
	INSWW3665	65"	36"	\$723	+\$74	+\$106	-\$74	+\$232	+\$942
INSWW3671	71"	36"	\$814	+\$81	+\$111	-\$80	+\$261	+\$931	

System

Worksurfaces

Panel Mounted Worksurfaces

Storwal Saddle Tops

Product code key example

INSWSD3047

IN	Inscape System
SWSD	Storwal saddle worksurface
30	30" deep
47	47" wide

General information

- Storwal worksurfaces are 1" less in length than standard worksurfaces
- When manually specifying worksurface of laminate or veneer add suffix "-S" to the code
- Optional pencil groove with Nuform
- To manually specify Nuform worksurfaces; begin with the desired thickness then build up options
- 1" thick worksurfaces are not available in laminate or veneer
- Stretcher bars are required to be specified with worksurfaces 54" and wider which do have any mid support- ensure not to interfere with support brackets, cable trays or other work tools

Notes



In order to get a total cost on products when an upcharge or downcharge is present you take the list price of the product number and add the upcharge or deduct the downcharge cost shown to the list price.

For example:

Product INSWSD3047 in Nuform Woodgrain with a tapered edge would be \$492 +\$50 +\$27

Product INSWSD3047 in Nuform Woodgrain with a 1" straight edge would be \$492 +\$50 -\$49

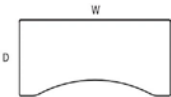
Product INSWSD3047 in veneer would be \$492 +\$744

Description	Part number	Width	Depth	1 1/4" straight edge nuform solid/laminate	Nuform woodgrain/pattern	Nuform tapered edge	1" straight edge nuform solid	Grade 1 laminate 1 1/4" straight edge only	Veneer 1 1/4" straight edge only
 30" Storwal Saddle Top	INSWSD3047	47"	30"	\$492	+\$50	+\$27	-\$49	+\$158	+\$744
	INSWSD3053	53"	30"	\$552	+\$57	+\$28	-\$55	+\$177	+\$753
	INSWSD3059	59"	30"	\$616	+\$64	+\$31	-\$63	+\$198	+\$760
	INSWSD3065	65"	30"	\$656	+\$66	+\$34	-\$65	+\$210	+\$793
	INSWSD3071	71"	30"	\$738	+\$75	+\$36	-\$74	+\$237	+\$773
 36" Storwal Saddle Top	INSWSD3647	47"	36"	\$563	+\$55	+\$28	-\$60	+\$181	+\$846
	INSWSD3653	53"	36"	\$630	+\$64	+\$32	-\$63	+\$202	+\$858
	INSWSD3659	59"	36"	\$703	+\$74	+\$35	-\$73	+\$225	+\$865
	INSWSD3665	65"	36"	\$749	+\$76	+\$38	-\$75	+\$240	+\$905
	INSWSD3671	71"	36"	\$841	+\$84	+\$42	-\$83	+\$270	+\$883

Product code key example
INSWWG362459

IN Inscape System
SWWG Storwal galley worksurface
3624 36-24" deep
59 59" wide

General information

- Storwal worksurfaces are 1" less in length than standard worksurfaces
- When manually specifying worksurface of laminate or veneer add suffix "-S" to the code
- Optional pencil groove with Nuform
- To manually specify Nuform worksurfaces; begin with the desired thickness then build up options
- 1" thick worksurfaces are not available in laminate or veneer
- Stretcher bars are required to be specified with worksurfaces 54" and wider which do have any mid support- ensure not to interfere with support brackets, cable trays or other work tools

Notes



In order to get a total cost on products when an upcharge or downcharge is present you take the list price of the product number and add the upcharge or deduct the downcharge cost shown to the list price.

For example:

Product INSWWG362459 in Nuform Woodgrain with a tapered edge would be \$682 +\$71 +\$32

Product INSWWG362459 in Nuform Woodgrain with a 1" straight edge would be \$682 +\$71 -\$65

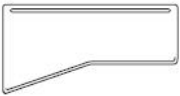
Product INSWWG362459 in veneer would be \$682 +\$1411

Description	Part number	Width	Depth	1 ¼" straight edge solid/laminate	Nuform woodgrain/pattern	Nuform tapered edge	1" straight edge nuform solid	Grade 1 laminate 1 ¼" straight edge only	Veneer 1 ¼" straight edge only
 Left Hand Storwal Galley Top	INSWWG362459	59"	36-24"	\$682	+\$71	+\$32	-\$65	+\$219	+\$1411
	INSWWG362465	65"	36-24"	\$733	+\$75	+\$35	-\$74	+\$235	+\$1470
	INSWWG362471	71"	36-24"	\$814	+\$82	+\$40	-\$81	+\$261	+\$1482
	INSWWG362477	77"	36-24"	\$902	+\$91	+\$46	-\$89	+\$289	+\$1487
	INSWWG362483	83"	36-24"	\$991	+\$102	+\$50	-\$100	+\$318	+\$1502
	INSWWG362489	89"	36-24"	\$1020	+\$103	+\$55	-\$101	+\$327	+\$1575
 Right Hand Storwal Galley Top	INSWWG243659	59"	24-36"	\$682	+\$71	+\$32	-\$65	+\$219	+\$1411
	INSWWG243665	65"	24-36"	\$733	+\$75	+\$35	-\$74	+\$235	+\$1470
	INSWWG243671	71"	24-36"	\$814	+\$82	+\$40	-\$81	+\$261	+\$1482
	INSWWG243677	77"	24-36"	\$902	+\$91	+\$46	-\$89	+\$289	+\$1487
	INSWWG243683	83"	24-36"	\$991	+\$102	+\$50	-\$100	+\$318	+\$1502
	INSWWG243689	89"	24-36"	\$1020	+\$103	+\$55	-\$101	+\$327	+\$1575
	INSWWG243695	95"	24-36"	\$1070	+\$108	+\$59	-\$103	+\$343	+\$1624

Worksurfaces

Transaction tops
General information

General information

Transaction tops are commonly specified for reception areas but have a variety of applications including help desks and banks.

Transaction Tops are commonly specified with 37" high panels. Widths indicated refer to panel width. Stanchions and top trim are included. Installed height of transaction top on 37" high panel is 41 1/2". Transaction Top worksurfaces are 1" thick and available in Nuform options. The edge detail is straight only. Transaction tops are panel thickness specific.

The suffix "2F" denotes compatibility with 2 3/4" thick panel, "3F" denotes compatibility with 3 1/2" thick panel. Hi-Lo Transaction Top must be specified when a transaction top is specified directly adjacent to a higher panel. The worksurface takes into account the profile of the end trim.

Note: 72", 84" and 96" w kits consist of two top caps and four stanchions (based on "Symmetrical Frame Configuration" module lines). Top Caps can be specified as an option and are included with the kit.

Product code key example

INTT1236-3F

INTT	Inscape System rectangular transaction top
12	12" deep
36	36" wide
3F	3 1/2" thick frame application

R in the code indicates one end has a right-handed 90° miter.

L in the code indicates one end has a left-handed 90° miter.

HL in the code indicates one end is for a hi-lo application.

General

- Straight-line and curved transaction tops are available
- Straight-line transaction tops are 12" deep and are available in the following widths: 24", 30", 36", 42", 48", 54", 60", 72", 84" and 96"
- Transaction tops may be specified for 37" standard frames. Overall height of 37" high frame and transaction top is 41 1/2"
- Hi-Lo tops are shorter than the module line and may be specified for hi-lo applications
- All transaction tops, shorter than 72" wide, are supported by 2 stanchions
- Transaction tops 72" or wider include two top trims and four stanchions
- A top trim with two cut-outs, to accommodate the stanchions, is included with each transaction top
- Stanchions are not height adjustable
- Transaction tops are available in several shapes and sizes to accommodate a variety of configurations including hi-lo, straight line and 90°
- Transaction top codes indicate the size and shape of the top, see below.
- Do not specify upper deck electrical beneath

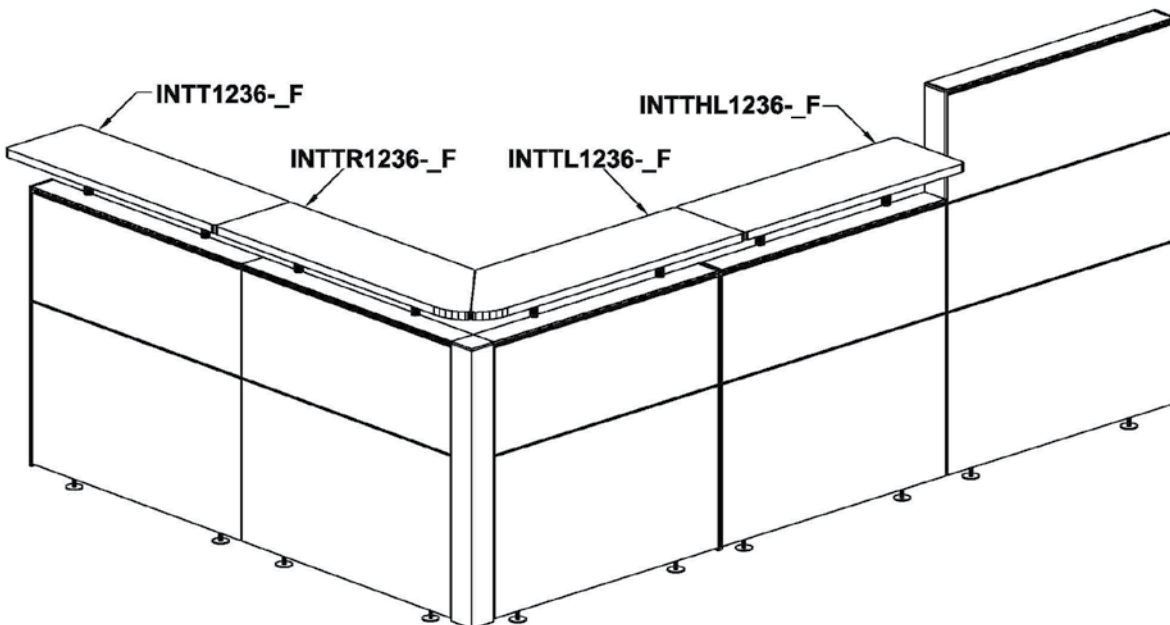

The above hypothetical configuration illustrates transaction tops specified in a variety of configurations.

General information



- Straight Edge Nuform worksurface
- Specific frame configurations only for the spanning tops
- 1" thick worksurface
- 72" (36" top caps), 84" (42" top caps) and 96" (48" top caps) wide kits consist of two top caps and four stanchions
- On-module installation only
- Stanchions have a rectangular profile

Notes

In order to get a total cost on products when an upcharge or downcharge is present you take the list price of the product number and add the upcharge or deduct the downcharge cost shown to the list price.

For example:

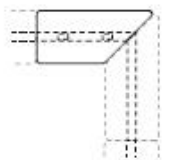
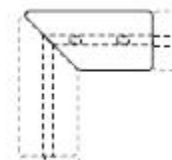
Product INTL1224-3F in Nuform Woodgrain with tapered trim would be \$325 +\$17

Description	Part number	Height	Width	Tapered trim		Flat trim		Accent paint upcharge
				1" Straight edge nuform solid	1" Nuform woodgrain/pattern	1" Straight edge nuform solid	1" Nuform woodgrain/pattern	
 Rectangular Transaction Top	INTT1224-3F	12"	24"	\$325	+\$17	\$325	+\$17	+\$33
	INTT1230-3F	12"	30"	\$348	+\$18	\$348	+\$18	+\$36
	INTT1236-3F	12"	36"	\$370	+\$19	\$370	+\$19	+\$38
	INTT1242-3F	12"	42"	\$392	+\$21	\$392	+\$21	+\$40
	INTT1248-3F	12"	48"	\$423	+\$23	\$423	+\$23	+\$43
	INTT1254-3F	12"	54"	\$445	+\$24	\$445	+\$24	+\$45
	INTT1260-3F	12"	60"	\$450	+\$24	\$450	+\$24	+\$46
	INTT1272-3F	12"	72"	\$739	+\$37	\$739	+\$37	+\$75
	INTT1284-3F	12"	84"	\$782	+\$39	\$782	+\$39	+\$79
INTT1296-3F	12"	96"	\$837	+\$42	\$837	+\$42	+\$85	
 Left Hand Miter Transaction Top	INTL1224-3F	12"	24"	\$351	+\$18	\$351	+\$18	+\$36
	INTL1230-3F	12"	30"	\$374	+\$19	\$374	+\$19	+\$38
	INTL1236-3F	12"	36"	\$394	+\$21	\$394	+\$21	+\$40
	INTL1242-3F	12"	42"	\$419	+\$22	\$419	+\$22	+\$43
	INTL1248-3F	12"	48"	\$448	+\$24	\$448	+\$24	+\$46
	INTL1254-3F	12"	54"	\$504	+\$26	\$504	+\$26	+\$51
	INTL1260-3F	12"	60"	\$518	+\$27	\$518	+\$27	+\$52
	INTL1272-3F	12"	72"	\$761	+\$38	\$761	+\$38	+\$77
	INTL1284-3F	12"	84"	\$803	+\$40	\$803	+\$40	+\$82
INTL1296-3F	12"	96"	\$859	+\$43	\$859	+\$43	+\$87	
 Right Hand Miter Transaction Top	INTR1224-3F	12"	24"	\$351	+\$18	\$351	+\$18	+\$36
	INTR1230-3F	12"	30"	\$374	+\$19	\$374	+\$19	+\$38
	INTR1236-3F	12"	36"	\$394	+\$21	\$394	+\$21	+\$40
	INTR1242-3F	12"	42"	\$419	+\$22	\$419	+\$22	+\$43
	INTR1248-3F	12"	48"	\$448	+\$24	\$448	+\$24	+\$46
	INTR1254-3F	12"	54"	\$504	+\$26	\$504	+\$26	+\$51
	INTR1260-3F	12"	60"	\$518	+\$27	\$518	+\$27	+\$52
	INTR1272-3F	12"	72"	\$761	+\$38	\$761	+\$38	+\$77
	INTR1284-3F	12"	84"	\$803	+\$40	\$803	+\$40	+\$82
INTR1296-3F	12"	96"	\$859	+\$43	\$859	+\$43	+\$87	
 Hi Lo One Side Rectangular Transaction Top	INTHL1224-3F	12"	24"	\$323	+\$17	\$323	+\$17	+\$33
	INTHL1230-3F	12"	30"	\$346	+\$18	\$346	+\$18	+\$35
	INTHL1236-3F	12"	36"	\$368	+\$19	\$368	+\$19	+\$38
	INTHL1242-3F	12"	42"	\$390	+\$21	\$390	+\$21	+\$40
	INTHL1248-3F	12"	48"	\$421	+\$23	\$421	+\$23	+\$43
	INTHL1254-3F	12"	54"	\$443	+\$24	\$443	+\$24	+\$45
	INTHL1260-3F	12"	60"	\$459	+\$24	\$459	+\$24	+\$47
	INTHL1272-3F	12"	72"	\$737	+\$37	\$737	+\$37	+\$75
	INTHL1284-3F	12"	84"	\$780	+\$38	\$780	+\$38	+\$79
INTHL1296-3F	12"	96"	\$817	+\$40	\$817	+\$40	+\$83	

System

Worksurfaces

Transaction Tops
For 2 3/4" Thick Frames

General information



- Straight Edge Nuform worksurface
- Specific frame configurations only for the spanning tops
- 1" thick worksurface
- 72" (36" top caps), 84" (42" top caps) and 96" (48" top caps) wide kits consist of two top caps and four stanchions
- On-module installation only
- Stanchions have a rectangular profile

Notes

In order to get a total cost on products when an upcharge or downcharge is present you take the list price of the product number and add the upcharge or deduct the downcharge cost shown to the list price.

For example:

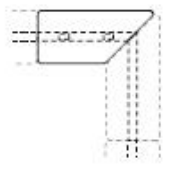
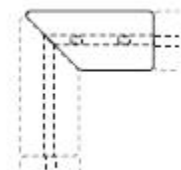
Product INTT1224-2F in Nuform Woodgrain with flat trim would be \$325 +\$17

Description	Part number	Height	Width	Tapered trim		Flat trim		Accent paint upcharge
				1" Straight edge nuform solid	1" Nuform woodgrain/pattern	1" Straight edge nuform solid	1" Nuform woodgrain/pattern	
 Rectangular Transaction Top	INTT1224-2F	12"	24"	—	—	\$325	+\$17	+\$33
	INTT1230-2F	12"	30"	—	—	\$348	+\$18	+\$36
	INTT1236-2F	12"	36"	—	—	\$370	+\$19	+\$38
	INTT1242-2F	12"	42"	—	—	\$392	+\$21	+\$40
	INTT1248-2F	12"	48"	—	—	\$423	+\$23	+\$43
	INTT1254-2F	12"	54"	—	—	\$445	+\$24	+\$45
	INTT1260-2F	12"	60"	—	—	\$450	+\$24	+\$46
	INTT1272-2F	12"	72"	—	—	\$739	+\$37	+\$75
	INTT1284-2F	12"	84"	—	—	\$782	+\$39	+\$79
INTT1296-2F	12"	96"	—	—	\$837	+\$42	+\$85	
 Left Hand Miter Transaction Top	INTL1224-2F	12"	24"	—	—	\$351	+\$18	+\$36
	INTL1230-2F	12"	30"	—	—	\$374	+\$19	+\$38
	INTL1236-2F	12"	36"	—	—	\$394	+\$21	+\$40
	INTL1242-2F	12"	42"	—	—	\$419	+\$22	+\$43
	INTL1248-2F	12"	48"	—	—	\$448	+\$24	+\$46
	INTL1254-2F	12"	54"	—	—	\$504	+\$26	+\$51
	INTL1260-2F	12"	60"	—	—	\$518	+\$27	+\$52
	INTL1272-2F	12"	72"	—	—	\$761	+\$38	+\$77
	INTL1284-2F	12"	84"	—	—	\$803	+\$40	+\$82
INTL1296-2F	12"	96"	—	—	\$859	+\$43	+\$87	
 Right Hand Miter Transaction Top	INTR1224-2F	12"	24"	—	—	\$351	+\$18	+\$36
	INTR1230-2F	12"	30"	—	—	\$374	+\$19	+\$38
	INTR1236-2F	12"	36"	—	—	\$394	+\$21	+\$40
	INTR1242-2F	12"	42"	—	—	\$419	+\$22	+\$43
	INTR1248-2F	12"	48"	—	—	\$448	+\$24	+\$46
	INTR1254-2F	12"	54"	—	—	\$504	+\$26	+\$51
	INTR1260-2F	12"	60"	—	—	\$518	+\$27	+\$52
	INTR1272-2F	12"	72"	—	—	\$761	+\$38	+\$77
	INTR1284-2F	12"	84"	—	—	\$803	+\$40	+\$82
INTR1296-2F	12"	96"	—	—	\$859	+\$43	+\$87	
 Hi Lo One Side Rectangular Transaction Top	INTHL1224-2F	12"	24"	—	—	\$323	+\$17	+\$33
	INTHL1230-2F	12"	30"	—	—	\$346	+\$18	+\$35
	INTHL1236-2F	12"	36"	—	—	\$368	+\$19	+\$38
	INTHL1242-2F	12"	42"	—	—	\$390	+\$21	+\$40
	INTHL1248-2F	12"	48"	—	—	\$421	+\$23	+\$43
	INTHL1254-2F	12"	54"	—	—	\$443	+\$24	+\$45
	INTHL1260-2F	12"	60"	—	—	\$459	+\$24	+\$47
	INTHL1272-2F	12"	72"	—	—	\$737	+\$37	+\$75
	INTHL1284-2F	12"	84"	—	—	\$780	+\$38	+\$79
INTHL1296-2F	12"	96"	—	—	\$817	+\$40	+\$83	

'L' Legs - height adjustable

'L' legs are manually height adjustable at 1.5" increments to achieve 5 standard worksurface heights: 25.5", 27", 28.5", 30" and 31.5". Feet are available in nominal widths of 24" and 30" for specification beneath 24" and 30" deep worksurfaces. Legs may be specified with a slide glide front and rear or with a caster on the rear and a slide glide on the front. Black nylon slide glides are dome-shaped at the bottom for easy maneuverability over carpeted floors. Dual wheel, non-locking fixed casters are also manufactured from black nylon. Casters are approximately 2 1/4" in diameter. Manual height adjustable 'L' legs adjust (without tools) by loosening a thumbscrew located on the inner side of the leg. Height adjustable 'L' legs are handed.

Leg docking bracket

Leg docking bracket information can be found in the "Inscape System Application Guide" section for specification guidelines. To be specified with 'L' legs on-module.

'C' Legs - height adjustable & fixed height

'C' legs - height adjustable & fixed height feet are 18" wide and may be specified beneath 24" and 30" deep worksurfaces where noted in the price list. Feet on 'C' legs are available with slide glides only. Foot docking brackets cannot be specified with 'C' legs.

End gable & end gable brackets

End gable & end gable brackets support panel mounted worksurfaces 28.5" high and. The left and right-handed brackets match the height of the end gable. End gables and brackets are available in any of Inscape's standard paint finishes and are frame thickness specific.

'H' Leg

'H' leg is a freestanding leg which may also be specified in a panel mounted application. Small glides provide leveling capability.

'O' leg

'O' leg is a fully welded 'O' structure which mounts to the underside of a worksurface. This leg is freestanding.

Framed leg

Framed leg is a panel mounted worksurface support that has the bracket to attach to panel incorporated in the design. Legs are specified based on depth of worksurface. Small leveling glide included with no glide cap. For version with glide cap see standard specials.

Cantilever bracket

Cantilever brackets support panel mounted worksurfaces on-module and are available in fixed or adjustable. Brackets are handed and adjustable to achieve 5 standard worksurface heights: 24.5", 27", 28.5", 30" and 31.5". Fixed cantilever brackets do not adjust vertically.

Mid span cantilever bracket

The mid span cantilever bracket is specified when there is a long tile being specified in the zone directly above the bottom 20.25"h tile which would interfere with the middle upright for a standard cantilever to attach into. The Mid Span Cantilever mounts lower to the upright allowing the wide tile aesthetic.

Corner cantilever bracket

The corner cantilever bracket is specified where the 1" gap behind a worksurface wraps around a corner.

Bridge bracket

Bridge bracket install onto Cantilever brackets only. These brackets are handed and an adjustable version is available to achieve the same five heights as Cantilever brackets. Fixed bridge brackets do not adjust vertically and must only be specified with fixed Cantilever brackets.

Flush brackets

Flush brackets are specified when two adjoining worksurfaces need to be held flush together and come in pairs. Maximum span of overhang when supported with a flush bracket is 18" per side.

Multi surface support brackets

Multi surface support brackets are adjustable to achieve five standard worksurface heights: 25.5", 27", 28.5", 30" and 31.5". MSSB's provide corner support for panel-mounted worksurfaces, support panel mounted conference tops and provide mid-span support for worksurfaces up to 72" wide. MSSB's are handed and may be specified for either thickness of Inscape System panel. Fixed Multi-surface Support Brackets are available and do not adjust vertically.

Front edge support brackets

Front edge support brackets provide front edge support for 24" and 30" deep worksurfaces and also dock freestanding tables to panel's on-module. Brackets may be positioned to achieve five standard worksurface heights. Front Edge Support Brackets are handed and may be specified for either thickness of panel.

Framed leg front support bracket

The framed leg front support bracket provides additional stability to a wing panel which is longer than the depth of the adjacent worksurface. The bracket must have access to a crossrail (at any location within the height of the leg) via a segmentation in tiles. The bracket is then double side taped to the inside of the leg.

Planna support bracket

Planna support bracket is specified to be mounted on Planna rail and floats the worksurface off the bracket. Bracket is available in all standard paint colors. Bracket "snaps" into the rail without the need for tools. These are shipped as a pair and both must be installed per worksurface.

Hat channel

Hat channels are used to support a worksurface off of a 21"ID Planna storage case and are available in any of Inscape's standard paint finishes. They are nominal in height and support a worksurface at a standard 28.5" height.

Storwal support bracket

Bracket suspends a Storwal worksurface from a Storwal unit and is available as adjustable or fixed height. Available in all standard paint colors and tools are not required in order to "snap" into place on Storwal unit. Brackets ship in pairs and both must be installed per application.

Worksurface stretcher bar

Worksurface stretcher bar is additional structural support for unsupported worksurfaces of 54" or greater. It is 1 1/2" high and the length of the stretcher bar is chosen based on the width of the worksurface. Be sure that there are no legs or panel mounted worksurface support brackets that may interfere with the stretcher bar.

Worksurface to tower bracket

This bracket is attached to a storage unit with screws (included) to support a worksurface from the underside. The 18"w bracket is used in a lateral, bookcase or locker application. The 24"w bracket is used with modular and workplace towers. These brackets are painted. Silicone caps to cover exposed screw tips are provided.

1.5" Screen docking brackets

Brackets dock the screen to a worksurface but are NOT worksurface supporting. Worksurfaces must always be freestanding. The Single Docking bracket docks one surface to a screen, the double docks two surfaces on either side of the screen. The Front edge docks the front edge of a freestanding table to the edge of a screen. Mid Span Docking bracket simply dock the mid of the worksurface to the 1.5" screen but does not support it.

System

Worksurfaces

Supports

Panel Mounted Worksurface Supports

General information

- Worksurface support brackets are universal between two panel thicknesses (unless otherwise stated)
- Value Engineer Option – Eco Black finish
- If visible it is suggested the paint option be chosen
- Cantilevers cannot be specified to support 20"d or less worksurfaces





Notes

In order to get a total cost on products when an upcharge or downcharge is present you take the list price of the product number and add the upcharge or deduct the downcharge cost shown to the list price.

For example:

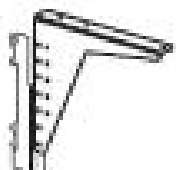
INLHCBFX in neutral paint would be \$38 +\$10

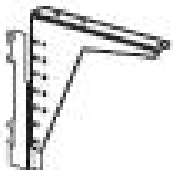
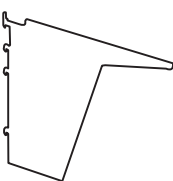
INLHCBFX in accent paint would be \$38 +\$10 +\$5

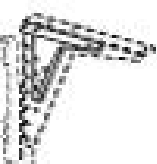
Description	Part number	Height	Weight (lbs)	Eco black/ base price	Neutral paint upcharge	Accent paint upcharge
 Cantilever Bracket Fixed Height Handed	INLHCBFX	—	5	\$38	+\$10	+\$5
	INRHCBFX	—	5	\$38	+\$10	+\$5
 Cantilever Bracket Adjustable Height Handed	INLHCB	—	5	\$46	+\$16	+\$6
	INRHCB	—	5	\$46	+\$16	+\$6
 Mid Span Cantilever Bracket Fixed Height Handed	INLHCBS	—	5	\$69	+\$10	+\$8
	INRHCBS	—	5	\$69	+\$10	+\$8
 Corner Cantilever Bracket Adjustable Height Handed	INLHCB1CRNR	—	5	\$80	+\$10	+\$9
	INRHCB1CRNR	—	5	\$80	+\$10	+\$9
 Reform Cantilever Bracket Fixed Height Handed	INLHCBR	—	5	\$106	+\$10	+\$12
	INRHCBR	—	5	\$106	+\$10	+\$12
 Bridge Bracket Fixed Height	INBBFX	—	1	\$12	+\$5	+\$3
 Bridge Bracket Adjustable Height Handed	INLBB	—	1	\$21	+\$8	+\$3
	INRBB	—	1	\$21	+\$8	+\$3

General information

- Worksurface support brackets are universal between two panel thicknesses (unless otherwise stated)
- Value Engineer Option – Eco Black finish
- If visible it is suggested the paint option be chosen
- A break in tile segmentation (horizontally) below the worksurface must be present for the Framed Leg Front Support Bracket to attach to the crossrail of the panel
- “H” Leg Docking Bracket ties an “H” leg or “O” leg into a frame

Notes

In order to get a total cost on products when an upcharge or downcharge is present you take the list price of the product number and add the upcharge or deduct the downcharge cost shown to the list price.

For example:

INLHMSSBFX in neutral paint would be \$18 +\$5

INLHMSSBFX in accent paint would be \$18 +\$5 +\$3

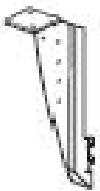
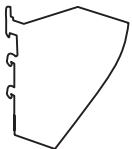
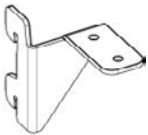
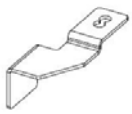
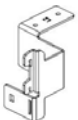
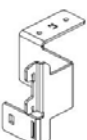
Description	Part number	Height	Weight (lbs)	Eco black/ base price	Neutral paint upcharge	Accent paint upcharge
Reform Bridge Bracket Fixed Height	INLBBR INRBRR	— —	1 1	\$53 \$53	+\$8 +\$8	+\$7 +\$7
	Multi Surface Support Bracket Fixed Height	—	2	\$18	+\$5	+\$3
	INLHMSSBFX INRHMSSBFX	— —	2 2	\$18 \$18	+\$5 +\$5	+\$3 +\$3
	Multi Surface Support Bracket Adjustable Height Handed	— —	2 2	\$31 \$31	+\$8 +\$8	+\$4 +\$4
	INLHMSSB INRHMSSB	— —	2 2	\$31 \$31	+\$8 +\$8	+\$4 +\$4
	Reform Multi Surface Support Bracket Fixed Height Handed	— —	2 2	\$53 \$53	+\$8 +\$8	+\$7 +\$7
	INLHMSSBR INRHMSSBR	— —	2 2	\$53 \$53	+\$8 +\$8	+\$7 +\$7
	Front Edge Support Bracket Fixed Height Handed	— —	1 1	\$23 \$23	+\$16 +\$16	+\$4 +\$4
	INLHFSB INRHFSB	— —	1 1	\$23 \$23	+\$16 +\$16	+\$4 +\$4
	Framed Leg Front Support Bracket Adjustable Height Handed	— —	1 1	— —	\$32 \$32	+\$5 +\$5
	INLHPFRSB INRHPSRSB	— —	1 1	— —	\$32 \$32	+\$5 +\$5
	“H” Leg Docking Bracket For use with 3 ½” T Frames Handed	— —	1 1	— —	\$74 \$74	+\$9 +\$9
	INLHHLDB-3F INRHHLDB-3F	— —	1 1	— —	\$74 \$74	+\$9 +\$9
	“H” Leg Docking Bracket For use with 2 ¾” T Frames Handed	— —	1 1	— —	\$74 \$74	+\$9 +\$9
	INLHHLDB-2F INRHHLDB-2F	— —	1 1	— —	\$74 \$74	+\$9 +\$9

System

Worksurfaces



Supports



Panel Mounted Worksurface Supports

General information

- “2F” denotes use with 2 ¾” thick frame, “3F” denotes use with 3 ½” thick frame
- Worksurface support brackets are universal between two panel thicknesses (unless otherwise stated)
- Value Engineer Option – Eco Black finish
- If support is visible it is suggested the paint option be chosen
- End panel must be docked to the frame with brackets
- Frame Support Leg mounts to both thicknesses of panel

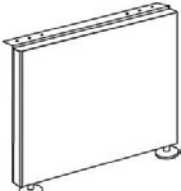
- Frame Support Legs are handed and based on which side of frame attaching to
- The Center Frame Support Leg cannot be used in an end location

Description	Part number	Height	Weight (lbs)	Eco black/ base price	Neutral paint upcharge	Accent paint upcharge	
	End Panel Bracket For use with 3 ½” T Frames Handed	INLHEGB28.5-3F	28 ½”	5	—	\$81	+\$9
		INRHEGB28.5-3F	28 ½”	5	—	\$81	+\$9
	End Panel Bracket For use with 2 ¾” T Frames Handed	INLHEGB28.5-2F	28 ½”	5	—	\$81	+\$9
		INRHEGB28.5-2F	28 ½”	5	—	\$81	+\$9
	End Panel	INEG2428.5	28 ½”	50	—	\$305	+\$31
		INEG3028.5	28 ½”	50	—	\$310	+\$32

Description	Part number	Height	Depth	Neutral paint/ base price	Accent paint upcharge	
	Left Hand Frame Support Leg New Style	INLFRMLEG2428.5	28 ½”	24”	\$340	+\$35
		INLFRMLEG3028.5	28 ½”	30”	\$381	+\$39
		INLFRMLEG3628.5	28 ½”	36”	\$424	+\$43
	Right Hand Frame Support Leg New Style	INRFRMLEG2428.5	28 ½”	24”	\$340	+\$35
		INRFRMLEG3028.5	28 ½”	30”	\$381	+\$39
		INRFRMLEG3628.5	28 ½”	36”	\$424	+\$43
	Centre Framed Support Leg New Style	INCFRMLEG2428.5	28 ½”	24”	\$340	+\$35
		INCFRMLEG3028.5	28 ½”	30”	\$381	+\$39
		INCFRMLEG3628.5	28 ½”	36”	\$424	+\$43

General information

- Value Engineer Option – Eco Black finish
- If bracket visible it is suggested the paint option be chosen
- Stretcher bars are required to be specified with worksurfaces 54” and wider which do have any mid support– ensure not to interfere with support brackets, cable trays or other work tools
- Stretcher bars are 1 ½” high



Notes



In order to get a total cost on products when an upcharge or downcharge is present you take the list price of the product number and add the upcharge or deduct the downcharge cost shown to the list price.

For example:

INWMB24-36 in neutral paint would be \$28 +\$8

INWMB24-36 in accent paint would be \$28 +\$8 +\$4

Description	Part number	Weight (lbs)	List price
 Flush Bracket Kit of 2	INFB	0.2	\$14
 20” Flush Bracket	INFB20	1	\$22
 Screws for Worksurfaces (box of 100)	INCBSCREWS	0.5	\$24

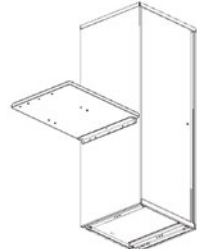
Description	Part number	Width	Weight (lbs)	Eco black/ base price	Neutral paint upcharge	Accent paint upcharge
 Worksurface Stretcher Bar For use with worksurfaces 54” and wider	INSBK54 For use with 54” surface	44”	—	\$66	—	—
	INSBK60 For use with 60” surface	50”	—	\$98	—	—
	INSBK72 For use with 72” surface	62”	—	\$117	—	—
	INSBK84 For use with 84” surface	74”	—	\$140	—	—
	INSBK96 For use with 96” surface	86”	—	\$159	—	—
 Wall Mount Bracket	INWMB24-36	24-36”	—	\$28	+\$8	+\$4
	INWMB42-54	42-54”	—	\$36	+\$10	+\$5
	INWMB60-72	60-72”	—	\$50	+\$14	+\$6
 Storage to worksurface bracket	INMTWBKT-18 Lateral/locker application	18”	—	—	\$31	+\$4
	INMTWBKT-24 Modular tower application	24”	—	—	\$45	+\$6

System



Worksurfaces

Supports

Storwal and Planna Worksurface Support Brackets



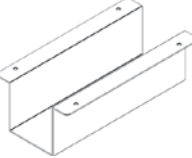
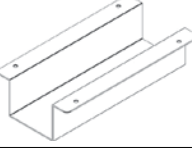

General information

- Planna Storage Support Brackets are shipped as a pair and are both required per Planna Storage worksurface installation
- Hat Channel heights are nominal and they support a standard worksurface height of 28.5"
- Storwal bracket adjustable to 5 standard heights

Description	Part number	Height	Weight (lbs)	Neutral paint/ base price	Accent paint upcharge
 <p>Planna Bracket (pair) Adjustable Height</p>	PSUPBKT	—	1	\$79	+\$9
 <p>9" W x 2.89"H Hat Channel For use over Planna case with ½" top with no rail</p>	HATCHNL2.89	2.89"	2	\$44	+\$6
 <p>9" W x 2.375"H Hat Channel For use over Planna case with ½" top and ½" rail</p>	HATCHNL2.3759	2.375"	2	\$44	+\$6
 <p>Storwal Bracket (pair)</p>	INWSUPBT-28.5 Fixed Height	1 ¼"	1	\$66	+\$8
	INWSUPBT-ADJ Adjustable Height	1 ¼"	1	\$114	+\$13

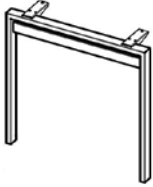
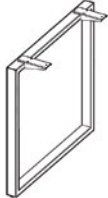
General information

- Height adjustable leg provides manual adjustability to five heights -25.5", 27", 28.5", 30", 31.5"
- Legs are available in any of Inscape's standard paint colors
- To adjust the height there are two bolts that unthread and then pull out so that inner leg can then move up and down

Description	Part number	Height	Weight (lbs)	Neutral paint/ base price	Accent paint upcharge
 <p>"H" Leg Fixed Height</p>	INHLEG2428.5	28 ½"	—	\$422	+\$43
	INHLEG3028.5	28 ½"	—	\$445	+\$45
	INHLEG3628.5	28 ½"	—	\$460	+\$47
 <p>"H" Leg Adjustable Height</p>	INHLEG24-ADJ	28 ½"	—	\$513	+\$52
	INHLEG30-ADJ	28 ½"	—	\$535	+\$54
	INHLEG36-ADJ	28 ½"	—	\$551	+\$56
 <p>"O" Leg Fixed Height</p>	INOLEG2428.5	28 ½"	—	\$351	+\$36
	INOLEG3028.5	28 ½"	—	\$362	+\$37
	INOLEG3628.5	28 ½"	—	\$366	+\$37
 <p>Post Leg Fixed Height Existing Storwal Storage version</p>	INLEG28.5F	28 ½"	3	\$166	+\$18
 <p>Post Leg Fixed Height</p>	INPLEG28.5F	28 ½"	5	\$172	+\$18
 <p>Post Leg Adjustable Height</p>	INPLEGM	28 ½"	7	\$277	+\$29

System







Worksurfaces

Supports

Legs and Leg Docking Brackets

General information

- Height adjustable leg provides manual adjustability to five heights -25.5", 27", 28.5", 30", 31.5"
- Legs are available in any of Inscape's standard paint colors
- The Triangular post leg provides concealed wire management

Description	Part number	Height	Weight (lbs)	Neutral paint/ base price	Accent paint upcharge
 Round Post Leg Fixed Height	INFFLEG28.5	28 ½"	4	\$76	+\$9
 Rectangular Post Leg	INRECPLEG-28.5 INRECPLEG-ADJ	28 ½" ADJUSTABLE"	— —	\$148 \$248	+\$16 +\$26
 Triangular Leg Fixed Height	INTWMLEG-28.5	28 ½"	—	\$224	+\$23
 "C" Leg Fixed Height	INCL1828.5F	28 ½"	7	\$334	+\$34
 "C" Leg Manual Adjustable Height Handed	INCLEG18MLH left-handed INCLEG18MRH right-handed	— —	8 8	\$415 \$415	+\$42 +\$42
 "L" Leg Fixed Height	INLLEG2428.5F INLLEG3028.5F	28 ½" 28 ½"	7 7	\$340 \$353	+\$35 +\$36

General information

- Height adjustable leg provides manual adjustability to five heights -25.5", 27", 28.5", 30", 31.5"
- Legs are available in any of Inscape's standard paint colors
- Leg docking bracket for use with "L" legs only – on module
- See "Inscape System Application Guide" for details of the Leg Docking Bracket

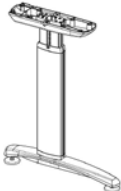
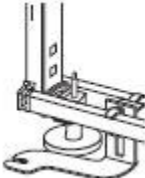
Description	Part number	Height	Weight (lbs)	Neutral paint/ base price	Accent paint upcharge
	"L" Leg				
	Manual Adjustable Height				
	Handed				
	INLLEG24MLH	—	8	\$415	+\$42
	INLLEG30MLH left-handed	—	8	\$426	+\$43
	INLLEG24MRH	—	8	\$415	+\$42
	INLLEG30MRH right-handed	—	8	\$426	+\$43
	"L" Leg Docking Bracket				
	Handed				
	INFDBLH left-handed	—	1	\$63	+\$8
	INFDBRH right-handed	—	1	\$63	+\$8

System



Worksurfaces

Supports

1 1/2" Screen Worksurfaces Docking Brackets

General information

- Docking brackets only, not worksurface supporting - legs for surfaces are required
- Compatible with 1" and 1 1/4" thick worksurfaces
- Brackets are available in any of Inscape's standard paint colors

Description	Part number	Weight (lbs)	Neutral paint/ base price	Accent paint upcharge
 1.5" Screen Single Docking Bracket	FWSDB	2	\$25	+\$4
 1.5" Screen Back to Back Docking Bracket	FWSBDB	2	\$39	+\$5
1.5" Screen Front Edge Docking Bracket	FWSFESB	2	\$28	+\$4
 1.5" Screen Mid-Span Docking Bracket	FF-MSSB	1	\$19	+\$3

General information

- Brackets are available in any of Inscape's standard paint colors
- Brackets attach to ADDWALL only

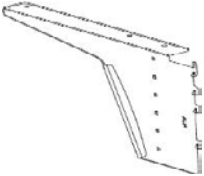
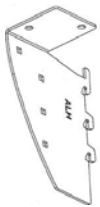
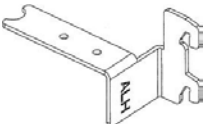
Description	Part number	Neutral paint/ base price	Accent paint upcharge
 <p>ADDWALL Cantilever Bracket</p>	INLHCBA	\$87	+\$10
	INRHCBA	\$87	+\$10
 <p>ADDWALL Multi Surface Support Bracket</p>	INLHMSSBA	\$55	+\$7
	INRHMSSBA	\$55	+\$7
 <p>ADDWALL Front Edge Support Bracket</p>	INLHFSBA	\$58	+\$7
	INRHFSBA	\$58	+\$7

Left blank intentionally.

system

Storage

System

Storage

Pedestals

General information

Pedestals are of all-welded “wrap-around” construction of 20 and 22 gauge high quality, tension leveled, cold rolled steel. The steel gauge selected for drawer fronts, bodies and accessories ensure the highest quality durability and performance for all components. All glides on cases consist of flat glides with $\frac{5}{8}$ ” height adjustability. Pedestal corners are welded at junction of top and case, eliminating horizontal lines for a cleaner, flush appearance, and strengthened with reinforcing gussets. A completely enclosed case provides rigid construction and dust-free interiors.

ANSI/BIFMA

With the addition of counterweights where appropriate, cabinets meet all BIFMA specifications.

Construction features & benefits

Box drawer sides are slotted on 1” centers to allow for maximum flexibility for drawer division. Double-wall construction allows lift-up doors to be picked up and recede smoothly, eliminates deformation, ensures flush fit within cabinet and improves lock performance. 7900 is single-wall construction. File (10.5” and 12”) and EDP (15”) drawer bodies have full-height sides to accommodate hanging file folders, eliminating the need for optional file frames. Fully progressive ball bearing suspensions on all drawers, including pencil and box drawers, are staged so that the left and right sides work in unison; this provides smooth drawer operation with minimum force. Staged suspensions allow the drawer to be completely pulled out, providing access to the entire drawer depth.

Special “claw-like” device incorporated in the suspension “grips” the fixed section of the suspension channel preventing drawer body bounce back or creep when drawer is closed. Modular interior allows complete interchangeability of drawer types within the pedestal case. For example, two 6” box drawers may be replaced by a 12” file drawer. Pedestals are standard with keyholes for attachment to underside of worksurface. For the 7900 only cases: 18” deep pedestals come standard with 18” deep drawers, 22” and 28” deep pedestals come standard with 22” deep drawers. For all other Series, pedestal drawers match case depth.

Pedestals are available in mobile and worksurface supporting. Worksurface supporting pedestals are designed for use with the Inscape System and are standard with flat glides. Worksurface supporting pedestals are available in two depths to fit under 24” and 30” deep worksurfaces and support finished worksurface height of 28.5”. Pedestals with 3”, 6” or 7.5” drawers include one pencil tray per pedestal. The 6” and 7.5” drawers also include a steel divider. The 10.5” and 12” drawers have one hang file suspension bar (two in a 28” deep pedestal) for side-to-side filing of legal or letter

size folders or printout binders. 7900 Pedestals do not include any suspension bars.

Note: System storage pedestal cases consist of holes in the top of the case and back of the case to allow for worksurface docking and panel mounted brackets to be secured.

Counterweights

Counterweights are required for ALL freestanding units that are not anchored or ganged to other cabinets or bolted to walls/floor.

Counterweights come standard with ALL mobile pedestals and must be field installed.

Docking bracket

The pedestal docking bracket docks a pedestal to an Inscape System panel on-module. Specify bracket according to case front style and based on the thickness of panel. ADDWALL pedestal-to-wall bracket docks a pedestal supporting a 24” deep worksurface to an ADDWALL movable wall on-module. Pedestal -to-panel brackets are available in full height version.

Glides

Inscape System pedestals are standard with flat glides. Glides provide 0.125” height adjustment when docked and 0.75” height adjustment if unit is not docked. 2 glides in front and 2 in back are adjustable from inside the cabinet so that cabinets can be leveled regardless of whether they are backed against a wall or banked.

Locks

Standard with single bitted lock. If lock is not required add suffix ‘/NL’ after product number and deduct \$48 list per lock. For applications requiring higher security a double bitted solution is available. Random keying is standard, and keyed alike may be ordered. Master keys are available; refer to the accessories section to specify.

Cabinets originally ordered as non-locking may be field installed with the addition of locking bars and a lock core. Contact your client services representative for required parts.

Locks feature removable core and are standard with two keys, one of which has a black neoprene plastic key cover. Locks may be ordered for field installation. Specify cabinet height and width or model number.

Note: Locks cannot be field installed on hinged door cabinets.

9900 Series Note: Pedestals with 9900 series fronts must be specified beneath Wood Veneer and 1” Nuform worksurfaces only.





Finishes

All laterals are finished in standard 36.5° gloss baked enamel, electrostatically applied

in a 2-coat process. Refer to the surface materials section for available colors. With the exception of custom micas, whites and metallic; custom colors are available at an up-charge and are be subject to extended lead times. All interior drawers/ shelf bodies, exposed hardware (excluding European style hinges) hang file bars, dividers and media frames are finished in Eco Black.

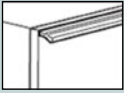
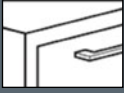
Front details & pull options

9900 Series fronts have full width integral pulls with enamel finish to match case fronts. 7900 is single-wall construction. Refer to the images and chart below for pull application on 7900 Series, Nuform, and Veneer fronts.

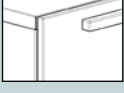
Pull	7900 Series	Nuform	Veneer
 <p>FP001 P290 Aluminum Leaf Finish</p>			
 <p>FP002 Matte Chrome Finish</p>			
 <p>FP004 Brushed Nickel Finish</p>			
 <p>FP005 Satin Nickel Finish</p>			
 <p>FP007 Brushed Nickel Finish</p>	+\$70	+\$70	+\$70
 <p>FP008 Matte Chrome Finish</p>	+\$70	+\$70	+\$70
 <p>FP009 Nickel Plated Matte Finish</p>	+\$70	+\$70	+\$70

Available

Unavailable

Pulls FP004, FP005, FP007 and FP008 meet the guidelines for ADA compliance.

FP005 is the default pull for 7900

FP001 is the default pull for Nuform and Veneer

Note: FP002 is not available on hinged door cabinets.

Cushion mobile pedestals

Cushion mobile pedestals are topped with 1.25" thick Cal.117 fire-retardant polyurethane foam with a 2.2lb/ft. density. This upholstery cushion is balanced with a 7/16" board and is attached to a pedestal top with Velcro. Select from our graded upholstery program of solid color fabrics and vinyl's or choose COM option (Customers Own Material). To determine if a COM fabric has been pre-approved for use on our cushion topper, contact your client services representative or log into INSITE. For application of ALL fabrics, both from our graded program as well as COM (Customer Own Material) please specify layout orientation at time of order. If layup instructions are not provided Inscape will choose the direction to maximize production. Refer to the diagram for layup options.

After calculating the total amount of material needed in inches, divide the total number of inches by 36 for the total yardage and round up to the next full yard. Allow additional for repeat. Add 15% of total fabric required for small and medium pattern repeats. Add 20% of total fabric required for large patterns.

Due to the nature of the design and manufacture of our cushion, only approved fabrics will be accepted for application. For a description of the procedure required for COM fabric approval see sample 'Cushion COM Test Request' form found in the General Information section of this price list. This form can be downloaded from the Administration section of Insite or by contacting your client services representative for assistance.

All directional/patterned fabrics (Graded or COM) require cushion layup instructions with order placement. Depending on layup additional fabric may be required and upcharges may apply. If layup instructions are not provided the layup that maximizes the production yield will be chosen. (Refer to the layup diagrams)

Fabric lay up of pedestal cushions

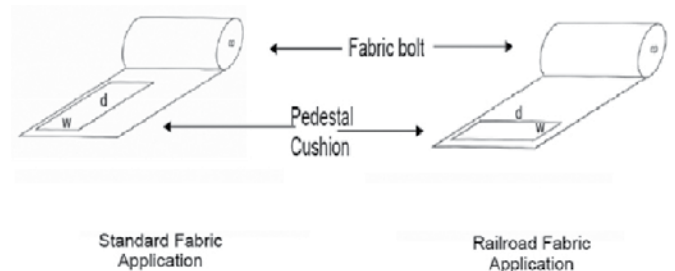

System



Storage

Pedestals

7900 Series Front Pedestals with Flat Glides

General information

- Consult General Information for pull options
- Includes worksurface mounting holes in top and bracket slots in back of case
- 15" letter width pedestal
- Worksurface supporting for 28.5" high

Description	Part number	Height	Width	Depth	Weight (lbs)	Neutral paint/ base price	Accent paint upcharge
 2-6" box, 12" file	GHF1522-2BF	26 7/8"	15"	22"	100	\$892	+\$90
	GHF1528-2BF	26 7/8"	15"	28"	110	\$938	+\$95
 2-12" files	GHF1522-2F	26 7/8"	15"	22"	100	\$783	+\$80
	GHF1528-2F	26 7/8"	15"	28"	110	\$808	+\$82
 3" pencil, 2-10.5" file	GHF1522-P2F10	26 7/8"	15"	22"	100	\$892	+\$90
	GHF1528-P2F10	26 7/8"	15"	28"	110	\$938	+\$95

General information

- Consult General Information for pull options
- Includes worksurface mounting holes in top and bracket slots in back of case
- 15" letter width pedestal
- Worksurface supporting for 28.5" high
- Rectangular glides are gray

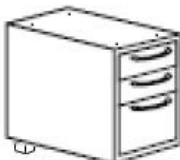
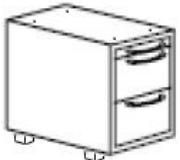
Description	Part number	Height	Width	Depth	Weight (lbs)	Neutral paint/ base price	Accent paint upcharge
 10.5" file, 12" file	INGH1522-F10F	26 7/8"	15"	22"	93	\$783	+\$80
	INGH1528-F10F	26 7/8"	15"	28"	105	\$808	+\$82
 2-6" box, 10.5" file	INGH1522-2BF10	26 7/8"	15"	22"	93	\$892	+\$90
	INGH1528-2BF10	26 7/8"	15"	28"	105	\$938	+\$95
 3" pencil, 7.5" box, 12" file	INGH1522-PB7F	26 7/8"	15"	22"	93	\$892	+\$90
	INGH1528-PB7F	26 7/8"	15"	28"	105	\$938	+\$95

System

Storage

Pedestals

7900 Series Front Mobile Pedestals

General information

- Consult General Information for pull options
- 15" letter width pedestal





Notes

In order to get a total cost on products when upcharges are present take the list price of the product number and add the upcharge cost shown to the list price.

For example:

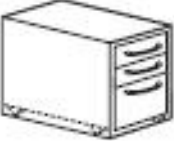
Product PH1518-BFMCNH in Grade B/COM fabric would be \$979 +\$48

PH1518-BFMCNH in Grade C fabric would be \$979 +\$89

Description	Part number	Height	Width	Depth	Weight (lbs)	List price/ Grade A	Accent paint upcharge
 2-6" box, 10.5" file Mobile No cushion	PH1518-2BF10M	26"	15"	18"	85	\$949	+\$96
	PH1522-2BF10M	26"	15"	22"	95	\$1052	+\$106
	PH1528-2BF10M	26"	15"	28"	105	\$1099	+\$111
 10.5" file, 12" file Mobile No cushion	PH1518-F10FM	26"	15"	18"	85	\$887	+\$90
	PH1522-F10FM	26"	15"	22"	95	\$949	+\$96
	PH1528-F10FM	26"	15"	28"	105	\$974	+\$98
 6" box, 12" file Mobile Includes cushion, no handle	PH1518-BFMCNH	22 3/4"	15"	18"	90	\$979	+\$99
	PH1522-BFMCNH	22 3/4"	15"	22"	100	\$1015	+\$102
	PH1528-BFMCNH	22 3/4"	15"	28"	105	\$1057	+\$107
 7.5" box, 10.5" file Mobile Includes cushion, no handle	PH1518B7F10MCNH	22 3/4"	15"	18"	90	\$949	+\$96
	PH1522B7F10MCNH	22 3/4"	15"	22"	100	\$1057	+\$107
	PH1528B7F10MCNH	22 3/4"	15"	28"	105	\$1099	+\$111



Fabric upcharge for mobile cushion pedestals

Note: To price fabric grade options, add the upcharge (+\$) in the chart below to the base price of the List price (Grade A) column This will be the total cost for that product.

Grade B/COM	Grade C	Grade D	Grade E	Grade F
+\$48	+\$89	+\$126	+\$151	+\$216

General information

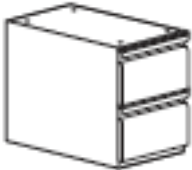
- Includes worksurface mounting holes in top and bracket slots in back of case
- Worksurface supporting for 28.5" high
- Recommended installation below 1" worksurfaces or veneer only for clean aesthetic due to the tight corner radius of the worksurface

Description	Part number	Height	Width	Depth	Weight (lbs)	Neutral paint/ base price	Accent paint upcharge	
	2-12" files Flat Glides	GEF1522-2F	26 7/8"	15"	22 3/4"	100	\$705	+\$81
		GEF1528-2F	26 7/8"	15"	28 3/4"	110	\$775	+\$84
		Letter Width						
		GEF1822-2F	26 7/8"	18"	22 3/4"	100	\$930	+\$94
		GEF1828-2F	26 7/8"	18"	28 3/4"	110	\$968	+\$98
		Legal Width						
	2-6" box, 1-12" file Flat Glides	GEF1522-2BF	26 7/8"	15"	22 3/4"	100	\$825	+\$91
		GEF1528-2BF	26 7/8"	15"	28 3/4"	110	\$900	+\$96
		Letter Width						
		GEF1822-2BF	26 7/8"	18"	22 3/4"	100	\$1051	+\$106
		GEF1828-2BF	26 7/8"	18"	28 3/4"	95	\$1103	+\$111
		Legal Width						
	3" pencil, 2-10.5" files Flat Glides	GEF1522-P2F10	26 7/8"	15"	22 3/4"	100	\$835	+\$92
		GEF1528-P2F10	26 7/8"	15"	28 3/4"	110	\$900	+\$96
		Letter Width						
		GEF1822-P2F10	26 7/8"	18"	22 3/4"	100	\$1052	+\$106
		GEF1828-P2F10	26 7/8"	18"	28 3/4"	110	\$1100	+\$111
		Legal Width						

System



Storage

Pedestals

9900 Series Front Pedestals with Rectangular Glides

General information

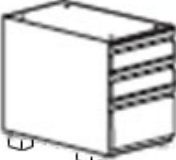
- Includes worksurface mounting holes in top and bracket slots in back of case
- Worksurface supporting for 28.5" high
- Recommended installation below 1" worksurfaces or veneer only for clean aesthetic due to the tight corner radius of the worksurface
- Rectangular glides are gray

Description	Part number	Height	Width	Depth	Weight (lbs)	Neutral paint/ base price	Accent paint upcharge		
	10.5" File, 12" File Rectangular Glides	INGE1522-F10F INGE1528-F10F Letter Width	26 7/8" 15"	22 3/4" 28 3/4"	95 105	\$797 \$828	+\$81 +\$84		
		INGE1822-F10F INGE1828-F10F Legal Width	26 7/8" 18"	22 3/4" 28 3/4"	100 110	\$930 \$968	+\$94 +\$98		
		2-6" box, 1-10.5" file Rectangular Glides	INGE1522-2BF10 INGE1528-2BF10 Letter Width	26 7/8" 15"	22 3/4" 28 3/4"	95 105	\$903 \$946	+\$91 +\$96	
			INGE1822-2BF10 INGE1828-2BF10 Legal Width	26 7/8" 18"	22 3/4" 28 3/4"	100 110	\$1051 \$1103	+\$106 +\$111	
			3" pencil, 7.5" box, and 12" file Rectangular Glides	INGE1522-PB7F INGE1528-PB7F Letter Width	26 7/8" 15"	22 3/4" 28 3/4"	95 105	\$905 \$950	+\$92 +\$96
				INGE1822-PB7F INGE1828-PB7F Legal Width	26 7/8" 18"	22 3/4" 28 3/4"	100 110	\$1052 \$1100	+\$106 +\$111

General information

- 15" letter width mobile pedestals

Notes



Optional handle for mobile cushion pedestals, add \$27 list per pedestal.

In order to get a total cost on products when upcharges are present take the list price of the product number and add the upcharge cost shown to the list price.

For example:

Product PF1518EBFMC in Grade B/COM fabric would be

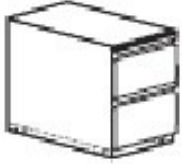
\$990 +\$48PF1518EBFMC in Grade C fabric would be \$990 +\$89

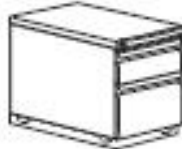
Description	Part number	Height	Width	Depth	Weight (lbs)	List price/ Grade A	Accent paint upcharge
 3" pencil, 6" box and 12" file No cushion	PE1518-PBFM	24 ½"	15"	18 ¾"	85	\$875	+\$96
	PE1522-PBFM	24 ½"	15"	22 ¾"	95	\$950	+\$104
	PE1528-PBFM	24 ½"	15"	28 ¾"	105	\$1025	+\$109
 2-10.5" files No cushion	PE1518-2F10.5M	24 ½"	15"	18 ¾"	85	\$899	+\$91
	PE1522-2F10.5M	24 ½"	15"	22 ¾"	95	\$959	+\$97
	PE1528-2F10.5M	24 ½"	15"	28 ¾"	105	\$992	+\$100
 6" box, 12" file Includes cushion	PF1518EBFMC	22 ¾"	15"	18 ¾"	90	\$900	+\$100
	PF1522EBFMC	22 ¾"	15"	22 ¾"	100	\$950	+\$104
	PF1528EBFMC	22 ¾"	15"	28 ¾"	110	\$1010	+\$108
 7.5" box, 10.5" file Includes cushion	PF1518EB7F10MC	22 ¾"	15"	18 ¾"	90	\$900	+\$100
	PF1522EB7F10MC	22 ¾"	15"	22 ¾"	100	\$950	+\$104
	PF1528EB7F10MC	22 ¾"	15"	28 ¾"	110	\$1010	+\$108

Fabric upcharge for mobile cushion pedestals

Note: To price fabric grade options, add the upcharge (+\$) in the chart below to the base price of the List price (Grade A) column This will be the total cost for that product.

Grade B/COM	Grade C	Grade D	Grade E	Grade F
+\$48	+\$89	+\$126	+\$151	+\$216

System

Storage

Pedestals

Nuform Front Pedestals with Flat Glides

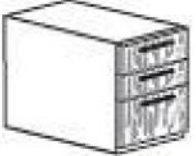

General information

- Consult General Information for pull options
- Includes worksurface mounting holes in top and bracket slots in back of case
- 15" letter width pedestal
- Worksurface supporting for 28.5" high
- Woodgrain and solid colors available

Description	Part number	Height	Width	Depth	Weight (lbs)	Neutral paint/ base price	Accent paint upcharge
 2-12" files Flat Glides	GQF1522-2F	26 7/8"	15"	22 3/4"	95	\$1073	+\$108
	GQF1528-2F	26 7/8"	15"	28 3/4"	105	\$1228	+\$123
 2-6" box, 1-12" file Flat Glides	GQF1522-2BF	26 7/8"	15"	22 3/4"	95	\$1200	+\$121
	GQF1528-2BF	26 7/8"	15"	28 3/4"	105	\$1317	+\$132

General information

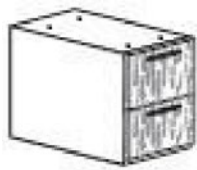
- Consult General Information for pull options
- Includes worksurface mounting holes in top and bracket slots in back of case
- 15" letter width pedestal
- Worksurface supporting for 28.5" high

Description	Part number	Height	Width	Depth	Weight (lbs)	Neutral paint/ base price	Accent paint upcharge
 2-12" file Flat Glides	GWF1522-2F	26 7/8"	15"	22 3/4"	95	\$1366	+\$138
	GWF1528-2F	26 7/8"	15"	28 3/4"	105	\$1500	+\$151
 2-6" box 1-12" file Flat Glides	GWF1522-2BF	26 7/8"	15"	22 3/4"	95	\$1568	+\$158
	GWF1528-2BF	26 7/8"	15"	28 3/4"	105	\$1670	+\$168

System

Storage

Pedestals

Pedestal Brackets

General information

- Pedestal brackets are full height and may be painted to match case finish
- The height is nominal and includes the thickness of the worksurface above the storage
- Specific brackets are required for case type and mounting application

- “2F” denotes use with 2 ¾” thick frame
- “3F” denotes use with 3 ½” thick frame
- Brackets are handed and are ordered based on which side of the frame the bracket is being mounted to

Description	Part number	Height	Weight (lbs)	Neutral paint/ base price	Accent paint upcharge
 <p>Full Height Pedestal Docking Bracket for 7900 Series, Nuform and Veneer fronts For use with 3 ½” T frames Handed</p>	IN28.5PEDLH-3F left handed	28 ½”	2	\$79	+\$9
	IN28.5PEDRH-3F right handed	28 ½”	2	\$79	+\$9
 <p>Full Height Pedestal Docking Bracket for 9900, Radius and Linear Series fronts For use with 3 ½” T frames Handed</p>	IN28.5PEDGLH-3F left handed	28 ½”	2	\$79	+\$9
	IN28.5PEDGRH-3F right handed	28 ½”	2	\$79	+\$9
 <p>Full Height Pedestal Docking Bracket for 7900 Series, Nuform and Veneer fronts For use with 2 ¾” T frames Handed</p>	IN28.5PEDLH-2F left handed	28 ½”	2	\$79	+\$9
	IN28.5PEDRH-2F right handed	28 ½”	2	\$79	+\$9
 <p>Full Height Pedestal Docking Bracket for 9900, Radius and Linear Series fronts For use with 2 ¾” T frames Handed</p>	IN28.5PEDGLH-2F left handed	28 ½”	2	\$79	+\$9
	IN28.5PEDGRH-2F right handed	28 ½”	2	\$79	+\$9
 <p>Full Height Pedestal Docking Bracket for 7900 Series, Nuform and Veneer fronts For use with 1 ½” T screens Handed</p>	PEDBRKTLH left handed	28 ½”	2	\$40	+\$5
	PEDBRKTRH right handed	28 ½”	2	\$40	+\$5
 <p>Full Height Pedestal Docking Bracket for 9900, Radius and Linear Series fronts For use with 1 ½” T screens Handed</p>	PEDBRKTFELH left handed	28 ½”	2	\$40	+\$5
	PEDBRKTFERH right handed	28 ½”	2	\$40	+\$5
 <p>Full Height Pedestal Docking Bracket For use with ADDWALL Handed</p>	INLHPSBFHA left handed	—	2	\$96	+\$11
	INRHPSBFHA right handed	—	2	\$96	+\$11

Lateral cabinets are of all-welded construction using 20 and 22 gauge high quality, tension leveled, and cold rolled steel. Drawer fronts, lift-up doors, roll-out shelves and all steel accessories are manufactured of the steel gauge appropriate to function at the highest quality level.

ANSI/BIFMA

With the addition of counterweights where appropriate, cabinets meet all BIFMA specifications.

Construction features & benefits

All interiors are completely modular and interchangeable so that cabinets can be retrofitted with new accessories and interiors as required. Cabinet corners are welded at junction of top and case, eliminating horizontal lines for cleaner, flush appearance, and strengthened with reinforcing gussets. Double-wall construction allows lift-up doors to be picked up and receded smoothly, eliminates deformation, ensures flush fit within cabinet and improves lock performance. Lift-up door carrier mechanism has four nylon rollers two on each side - for smooth receding action with no binding or snagging. Self-closing, 110° opening, European style cupboard hinges for smooth door operations. 7900 Series storage is single-wall construction.

The absence of scissor mechanism in doors and drawers eliminates the potential for scissors binding, and facilitates reconfiguration of cabinet openings as needed. Front leading edge of pullout shelves is beaded and rolled to provide grip for pullout action and strengthen shelf; front leading edge of fixed shelf is flat for easy removal of material. Fully progressive ball bearing suspension slides provide smooth action with minimum force.

Special "claw-like" device incorporated in suspension slide channel "grips" the fixed section of the suspension channel preventing drawer bounce-back or creep when drawer is closed. A patented Safelock™ interlock mechanism provides complete security and user safety against accidental opening of two or more drawers simultaneously. Lock fingers are configured with right angle bend upward not downward so that lift-up doors cannot be pulled down to disengage fingers from door slots and be forced to circumvent lock system. Lock bars operate vertically on both sides of cabinet for maximum security.

Laterals include 1 pair of hang file bars in 10.5" and 12" fixed fronts, 1 EDP kit in 13.5" and 15" fixed fronts, pencil tray in 3" multi-file drawer and steel divider in 7.5" multi-file drawer, steel divider in 6" multi-file drawers and 3 divider plates in 13.5" liftups. Fixed shelf in lift-up is slotted in 1" increments. Lateral-to-panel bracket is required if lateral is

positioned on-module.

Note: System storage laterals and multi-files consist of slots in the back of the case to allow for panel mounted brackets to be secured.

Counterweights

Counterweights are required for ALL freestanding units that are not anchored or ganged to other cabinets or bolted to walls/floor.

Counterweights come standard with ALL mobile pedestals and must be field installed.

Docking bracket

The Lateral Docking Bracket docks a lateral to an Inscape System panel on-module. Specify bracket according to depth of worksurface and based on the thickness of panel. ADDWALL lateral-to-wall bracket docks a lateral supporting a 24" deep worksurface to an ADDWALL movable wall on-module. For 30" deep worksurfaces, specify an ADDWALL right and left handed MSSB to dock worksurface to an ADDWALL movable wall. Counterweights are not required for laterals which are tied into the panel and worksurface supporting.

Glides

Inscape System laterals are standard with flat glides. Glides provide 0.125" height adjustment when docked and 0.625" height adjustment if unit is not docked. 2 glides in front and 2 in back are adjustable from inside the cabinet so that cabinets can be leveled regardless of whether they are backed against a wall or banked.

Locks

Standard with single bitted lock. If lock is not required add suffix '**NL**' after product number and deduct \$48 list per lock. For applications requiring higher security a double bitted solution is available. Random keying is standard, and keyed alike may be ordered. Master keys are available; refer to the accessories section to specify.

Cabinets originally ordered as non-locking may be field installed with the addition of locking bars and a lock core. Contact your client services representative for required parts.

Locks feature removable core and are standard with two keys, one of which has a black neoprene plastic key cover. Locks may be ordered for field installation. Specify cabinet height and width or model number.

Note: Locks cannot be field installed on hinged door cabinets.

Storage stabilizer bracket

Storage Stabilizer Bracket is specified when a storage case/Planna Storage lateral or pedestal is positioned directly adjacent to an Inscape System panel. This bracket does not create a gap between the case and the panel like a pedestal or lateral bracket does. No factory holes are required to be in the back of the case and are added at time of installation.

Finishes

All laterals are finished in standard 36.5° gloss baked enamel, electrostatically applied in a 2-coat process. Refer to Finishes section for available colors. With the exception of custom micas, whites and metallic; custom colors are available at an up-charge and are subject to extended lead times. All interior drawers/ shelf bodies, exposed hardware (excluding European style hinges) hang file bars, dividers and media frames are finished in Eco Black.

System





Storage

Laterals

General information

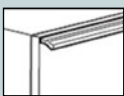
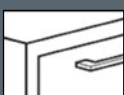
Front details & pull options

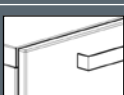
9900 Series fronts have full width integral pulls with enamel finish to match case fronts. 7900 is single-wall construction. Refer to the images and chart below for pull application on 7900 Series, Nuform, and Veneer fronts.

Pull	7900 Series	Nuform	Veneer
 <p>FP001 P290 Aluminum Leaf Finish</p>			
 <p>FP002 Matte Chrome Finish</p>			
 <p>FP004 Brushed Nickel Finish</p>			
 <p>FP005 Satin Nickel Finish</p>			
 <p>FP007 Brushed Nickel Finish</p>	+\$70	+\$70	+\$70
 <p>FP008 Matte Chrome Finish</p>	+\$70	+\$70	+\$70
 <p>FP009 Nickel Plated Matte Finish</p>	+\$70	+\$70	+\$70

Available

Unavailable

Pulls FP004, FP005, FP007 and FP008 meet the guidelines for ADA compliance.



FP005 is the default pull for 7900

FP001 is the default pull for Nuform & Veneer

Note: FP002 is not available on hinged door cabinets.

General information

- Includes slots in back for lateral to panel bracket, no holes on top
- Laterals are 18" deep
- Worksurface supporting for 28.5" high
- Consult General Information for pull options

Description	Part number	Height	Width	Weight (lbs)	Neutral paint/ base price	Accent paint upcharge
 3" pencil, 2-10.5" file Flat Glides	GHF3024-P2F10	26 7/8"	30"	105	\$967	+\$98
	GHF3624-P2F10	26 7/8"	36"	125	\$1054	+\$106
	GHF4224-P2F10	26 7/8"	42"	135	\$1146	+\$115
 2-12" files Flat Glides	GHF3024-FF	26 7/8"	30"	105	\$808	+\$82
	GHF3624-FF	26 7/8"	36"	125	\$889	+\$90
	GHF4224-FF	26 7/8"	42"	135	\$978	+\$99

System



Storage

Laterals

7900 Series Front Laterals with Rectangular Glides







General information

- Includes slots in back for lateral to panel bracket, no holes on top
- Laterals are 18" deep
- Worksurface supporting for 28.5" high
- Consult General Information for pull options
- **Rectangular glides have an upcharge of \$28 per unit**

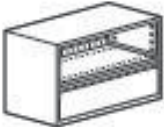
Description	Part number	Height	Width	Weight (lbs)	Neutral paint/ base price	Accent paint upcharge	
	10.5" file, 12" file	25 1/4"	30"	—	\$954	+\$96	
	Rectangular Glides	INGH3022.5-F10F	25 1/4"	36"	—	\$1046	+\$105
		INGH4222.5-F10F	25 1/4"	42"	—	\$1149	+\$116
	3" pencil, 7.5" box, 12" file	25 1/4"	30"	—	\$978	+\$99	
	Rectangular Glides	INGH3022.5-PB7F	25 1/4"	36"	—	\$1070	+\$108
		INGH4222.5-PB7F	25 1/4"	42"	—	\$1171	+\$118

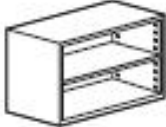
General information

- Includes slots in back for lateral to panel bracket, no holes on top
- Laterals are 18" deep
- Worksurface supporting for 28.5" high

Description	Part number	Height	Width	Weight (lbs)	Neutral paint/ base price	Accent paint upcharge	
	13.5 bookcase Insert, 10.5" file Flat Glides	GEF3024-BKF10	26 7/8"	30"	100	\$952	+\$96
		GEF3624-BKF10	26 7/8"	36"	125	\$1020	+\$103
		GEF4224-BKF10	26 7/8"	42"	135	\$1108	+\$112
	Display Cabinet Flat Glides	GEF3024-2MS	26 7/8"	30"	100	\$685	+\$70
		GEF3624-2MS	26 7/8"	36"	125	\$725	+\$74
		GEF4224-2MS	26 7/8"	42"	135	\$798	+\$81
	7.5" box, 16.5" bookcase insert Flat Glides	GEF3024-B7BK	26 7/8"	30"	98	\$1054	+\$106
		GEF3624-B7BK	26 7/8"	36"	108	\$1121	+\$113
		GEF4224-B7BK	26 7/8"	42"	121	\$1208	+\$121
	Bookcase with 1 shelf Flat Glides	GF3024-1BK18	26 7/8"	30"	49	\$829	+\$84
	Adjustable or fixed shelf options	GF3624-1BK18	26 7/8"	36"	57	\$855	+\$87
		GF4224-1BK18	26 7/8"	42"	65	\$868	+\$88
	2-12" files Flat Glides	GEF3024-FF	26 7/8"	30"	105	\$950	+\$96
		GEF3624-FF	26 7/8"	36"	125	\$995	+\$105
		GEF4224-FF	26 7/8"	42"	135	\$1040	+\$116
	2-6" box, 12" file Flat Glides	GEF3024-2BF	26 7/8"	30"	105	\$1091	+\$110
		GEF3624-2BF	26 7/8"	36"	125	\$1197	+\$120
		GEF4224-2BF	26 7/8"	42"	135	\$1318	+\$132
	3" pencil, 2-10.5" files Flat Glides	GEF3024-P2F10	26 7/8"	30"	105	\$1137	+\$114
		GEF3624-P2F10	26 7/8"	36"	125	\$1240	+\$125
		GEF4224-P2F10	26 7/8"	42"	135	\$1349	+\$135
	13.5 lift up with Fixed Shelf, 10.5" file Flat Glides	GEF3024-LUF10	26 7/8"	30"	105	\$951	+\$96
		GEF3624-LUF10	26 7/8"	36"	125	\$1050	+\$106
		GEF4224-LUF10	26 7/8"	42"	135	\$1163	+\$117

System



Storage

Laterals

9900 Series Front Laterals with Rectangular Glides





General information

- Includes slots in back for lateral to panel bracket, no holes on top
- Laterals are 18" deep
- Worksurface supporting for 28.5" high
- **Rectangular glides have an upcharge of \$28 per unit**

Description	Part number	Height	Width	Weight (lbs)	Neutral paint/ base price	Accent paint upcharge
 10.5" file, 12" file Rectangular Glides	INGE3022.5-F10F	25 1/4"	30"	—	\$954	+\$96
	INGE3622.5-F10F	25 1/4"	36"	—	\$1046	+\$105
	INGE4222.5-F10F	25 1/4"	42"	—	\$1149	+\$116
 2-6" box, 10.5" file Rectangular Glides	INGE3022.52BF10	25 1/4"	30"	—	\$1091	+\$110
	INGE3622.52BF10	25 1/4"	36"	—	\$1206	+\$121
	INGE4222.52BF10	25 1/4"	42"	—	\$1318	+\$132
 3" pencil, 7.5" box ,12" file Rectangular Glides	INGE3022.5-PB7F	25 1/4"	30"	—	\$978	+\$99
	INGE3622.5-PB7F	25 1/4"	36"	—	\$1070	+\$108
	INGE4222.5-PB7F	25 1/4"	42"	—	\$1171	+\$118

General information

- Includes slots in back for lateral to panel bracket, no holes on top
- Laterals are 18" deep
- Worksurface supporting for 28.5" high
- FP001 pull is standard. Consult General Information for pull options
- Woodgrain and solid colors available

Description	Part number	Height	Width	Weight (lbs)	Neutral paint/ base price	Accent paint upcharge
 2-12" files Flat Glides	GQF3024-2FF	26 7/8"	30"	95	\$1284	+\$129
	GQF3624-2FF	26 7/8"	36"	105	\$1380	+\$139
	GQF4224-2FF	26 7/8"	42"	115	\$1430	+\$144
 2-6" box, 12" file Flat Glides	GQF3024-2BF	26 7/8"	30"	95	\$1546	+\$156
	GQF3624-2BF	26 7/8"	36"	105	\$1650	+\$166
	GQF4224-2BF	26 7/8"	42"	115	\$1723	+\$173
 Nuform Front Hinged Door Cabinet with no interior accessories	GQF3024HD	26 7/8"	30"	75	\$966	+\$98
	GQF3624HD	26 7/8"	36"	95	\$1044	+\$105
	GQF4224HD	26 7/8"	42"	110	\$1184	+\$119
 Nuform Front Hinged Door Cabinet with 1 slotted shelf	GQF3024HD-SH	26 7/8"	30"	75	\$1052	+\$106
	GQF3624HD-SH	26 7/8"	36"	95	\$1130	+\$114
	GQF4224HD-SH	26 7/8"	42"	110	\$1271	+\$128

System





Storage

Laterals

Composite Veneer Front Laterals with Flat Glides

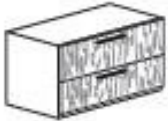





General information

- Includes slots in back for lateral to panel bracket, no holes on top
- Laterals are 18" deep
- Worksurface supporting for 28.5" high
- FP001 pull is standard. Consult General Information for pull options

Description	Part number	Height	Width	Weight (lbs)	Neutral paint/ base price	Accent paint upcharge
 2-12" files Flat Glides	GWF3024-2FF	26 7/8"	30"	95	\$1843	+\$185
	GWF3624-2FF	26 7/8"	36"	105	\$1907	+\$191
	GWF4224-2FF	26 7/8"	42"	115	\$1942	+\$195
 2-6" box, 12" file Flat Glides	GWF3024-2BF	26 7/8"	30"	95	\$2267	+\$228
	GWF3624-2BF	26 7/8"	36"	105	\$2377	+\$239
	GWF4224-2BF	26 7/8"	42"	115	\$2463	+\$247
 Composite Veneer Front Hinged Door Cabinet with no interior accessories	GWF3024HD	26 7/8"	30"	75	\$1115	+\$112
	GWF3624HD	26 7/8"	36"	95	\$1203	+\$121
	GWF4224HD	26 7/8"	42"	110	\$1368	+\$138
 Composite Veneer Front Hinged Door Cabinet with 1 slotted shelf	GWF3024HD-SH	26 7/8"	30"	75	\$1200	+\$121
	GWF3624HD-SH	26 7/8"	36"	95	\$1288	+\$129
	GWF4224HD-SH	26 7/8"	42"	110	\$1452	+\$146

General information

- Lateral brackets are full height and may be painted to match case finish
- The height is nominal and includes the thickness of the worksurface above the storage
- Specific brackets are required for case type and for worksurfaces depth
- “2F” denotes use with 2 ¾” thick frame
- “3F” denotes use with 3 ½” thick frame
- Brackets are handed and are ordered based on which side of the frame the bracket is being mounted to

Description	Part number	Height	Weight (lbs)	Neutral paint/ base price	Accent paint upcharge
 <p>Full Height Lateral Docking Bracket for 24”D worksurfaces For 7900, 9900 and Radius series For use with 3 ½” T frames Handed</p>	IN28.5LBLH-3F left handed	28 ½”	5	\$87	+\$10
	IN28.5LBRH-3F right handed	28 ½”	5	\$87	+\$10
 <p>Full Height Lateral Docking Bracket for 24”D worksurfaces For GRID series For use with 3 ½” T frames Handed</p>	IN28.5LBGLH-3F left handed	28 ½”	5	\$87	+\$10
	IN28.5LBGRH-3F right handed	28 ½”	5	\$87	+\$10
 <p>Full Height Lateral Docking Bracket for 30”D worksurfaces For all series For use with 3 ½” T frames Handed</p>	IN28.5LB30LH-3F left handed	28 ½”	5	\$113	+\$13
	IN28.5LB30RH-3F right handed	28 ½”	5	\$113	+\$13
 <p>Full Height Lateral Docking Bracket for 24”D worksurfaces For 7900, 9900 and Radius series For use with 2 ¾” T frames Handed</p>	IN28.5LBLH-2F left handed	28 ½”	5	\$87	+\$10
	IN28.5LBRH-2F right handed	28 ½”	5	\$87	+\$10
 <p>Full Height Lateral Docking Bracket for 24”D worksurfaces For GRID series For use with 2 ¾” T frames Handed</p>	IN28.5LBGLH-2F left handed	28 ½”	5	\$87	+\$10
	IN28.5LBGRH-2F right handed	28 ½”	5	\$87	+\$10
 <p>Full Height Lateral Docking Bracket for 30”D worksurfaces For all series For use with 2 ¾” T frames Handed</p>	IN28.5LB30LH-2F left handed	28 ½”	5	\$113	+\$13
	IN28.5LB30RH-2F right handed	28 ½”	5	\$113	+\$13

System



Storage

Laterals

Lateral Brackets

General information

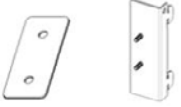
- “2F” denotes use with 2 ¾” thick frame
- “3F” denotes use with 3 ½” thick frame
- Stabilizer brackets cannot be used with Modular Towers as they have chamfered corners
- ADDWALL brackets are handed and are ordered based on which side of the frame the bracket is being mounted to

Description	Part number	Weight (lbs)	Neutral paint/ base price	Accent paint upcharge
 <p>Storage to Panel Stabilizer Bracket For use with 3 ½” T frames</p>	INPSSB-3F	1	\$40	+\$5
 <p>Storage to Panel Stabilizer Bracket For use with 2 ¾” T frames</p>	INPSSB-2F	1	\$40	+\$5
ADDWALL Lateral Bracket Handed	INLHPSBWSHA left handed	—	\$111	+\$12
	INRHPSBWSHA right handed	—	\$111	+\$12

Workplace Towers are constructed of all-welded construction using high quality, tension leveled cold rolled steel. The steel gauge selected for drawer fronts, bodies and accessories ensure the highest quality durability and performance for all components.

Safelock™

The patented Safelock mechanism is standard on the 42" wide locker and on towers and lockers that have more than one file (10.5" and 12") drawer. It provides complete security against accidental opening of two or more drawers simultaneously. When any drawer is extended, even fractionally, Safelock ensures that all other openings immediately become inoperable.

Drawer standard equipment

On pre-configured units, Lockers and towers containing 3" or 6" drawers are provided with one pencil tray per cabinet. 6" drawers are additionally standard with one steel divider. 10.5", 12" and 15" letter-width file drawers have one suspension bar for side-to-side filing of letter or legal-size folders. Full-width pullout drawers are standard with one pair hang file bars for side-to-side suspended filing. Full-width fixed shelves are standard with 3 plate dividers. Optional accessories are available. Build ups are ordered separately.

Glides

Overall heights are inclusive of metal glides. Heights may be increased up to 3/4" by extending the standard glide. Glides are accessible from inside the cabinet when the bottom drawer is fully extended or removed and may be adjusted with a 0.25" socket driver. Optional 1.5" stem glides are available.

Locks

Standard with single bitted lock. If lock is not required add suffix '/NL' after product number and deduct \$48 list per lock. For applications requiring higher security a double bitted solution is available. Random keying is standard, and keyed alike may be ordered. Master keys are available; refer to the accessories section to specify.

Cabinets originally ordered as non-locking may be field installed with the addition of locking bars and a lock core. Contact your client services representative for required parts.

Locks feature removable core and are standard with two keys, one of which has a black neoprene plastic key cover. Locks may be ordered for field installation. Specify cabinet height and width or model number.

Note: Locks cannot be field installed on hinged door cabinets.

Wardrobe units

Wardrobe units are available in two different variations; freestanding and Storwal Storage and widths of 12", 15" and 18"(the Storwal Storage version includes a 24" version). The freestanding version matches panel heights of 44", 51", 57" and 64"h. The Storwal version matches 51" and 64" versions. Wardrobe units are available in 9900 series, Nuform solid and Woodgrain and veneer (Storwal Storage 24" version only). Wardrobe units include the option of a coat rod and upper shelf or multiple shelves (quantities listed below)

44"h version includes 2 shelves
51"h version includes 2 shelves
57"h version includes 2 shelves
64"h version includes 3 shelves





Wardrobe units are locking and include flat glides on the freestanding versions. Storwal Storage versions include round or rectangular glide.

Finishes

All towers are finished in standard 36.5° gloss baked enamel, electrostatically applied in a 2-coat process. Refer to the surface materials section for available colors. With the exception of custom micas, whites and metallic; custom colors are available at an up-charge and are be subject to extended lead times. All interior drawers/ shelf bodies, exposed hardware (excluding European style hinges) hang file bars, dividers and media frames are finished in Eco Black.

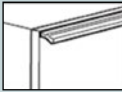
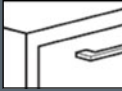
Front details & pull options

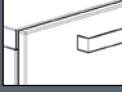
9900 Series fronts have full width integral pulls with enamel finish to match case fronts. 7900 is single-wall construction. Refer to the images and chart below for pull application on 7900 Series, Nuform, and Veneer fronts.

Pull	7900 Series	Nuform	Veneer
 FP001 P290 Aluminum Leaf Finish			
 FP002 Matte Chrome Finish			
 FP004 Brushed Nickel Finish			
 FP005 Satin Nickel Finish			
 FP007 Brushed Nickel Finish	+\$70	+\$70	+\$70
 FP008 Matte Chrome Finish	+\$70	+\$70	+\$70
 FP009 Nickel Plated Matte Finish	+\$70	+\$70	+\$70

Available Unavailable

Pulls FP004, FP005, FP007 and FP008 meet the guidelines for ADA compliance.

**FP005 is the default pull for 7900
FP001 is the default pull for Nuform & Veneer**

Note: FP002 is not available on hinged door cabinets.

System





Storage

Towers

7900 Series Front Workplace Towers

General information

- Consult General Information for pull options
- Towers are 24" deep
- Flat glides
- 49 3/8" H matches 51"H frame
- 62 7/8" H matches 64" H frame

Description	Part number	Height	Width	Weight (lbs)	Neutral paint/ base price	Accent paint upcharge
 <p>Full-length door 8 3/16" wide on one side, 27" hinged door insert and 2-10.5" file drawers 13 5/8" wide on the other Flat Glides</p>	GHFTL2446-2F10 left-handed hinged door (illustrated)	49 3/8"	24"	120	\$2698	+\$270
	GHFTR2446-2F10 right-handed hinged door	49 3/8"	24"	120	\$2698	+\$270
 <p>Full-length door 8 3/16" wide on one side, 27" hinged door insert, 1-7.5" file and 1-12" drawers 13 5/8" wide on the other Flat Glides</p>	GHFTL2446-B7F left-handed hinged door (illustrated)	49 3/8"	24"	120	\$2698	+\$270
	GHFTR2446-B7F right-handed hinged door	49 3/8"	24"	120	\$2698	+\$270
 <p>Full-length door 8 3/16" wide on one side, 36" high hinged door insert and 2-12" file drawers 13 5/8" wide on the other Flat Glides</p>	GHFTL2460-2F left-handed hinged door (illustrated)	62 7/8"	24"	185	\$2698	+\$270
	GHFTR2460-2F right-handed hinged door	62 7/8"	24"	185	\$2698	+\$270
 <p>Full-length door 8 3/16" wide on one side, 36" high hinged door insert, 2-6" box and 1-12" file drawers 13 5/8" wide on the other Flat Glides</p>	GHFTL2460-2BF left-handed hinged door (illustrated)	62 7/8"	24"	185	\$2698	+\$270
	GHFTR2460-2BF right-handed hinged door	62 7/8"	24"	185	\$2698	+\$270

General information

- Towers are 24" deep
- Flat glides
- Glides which come standard with towers will level to lower than the actual frame height
- System glides are required to be ordered separately in order to match top of 64"h frame top trim

CAUTION: Un-level floors may result in towers with leveling higher than the frame top trim

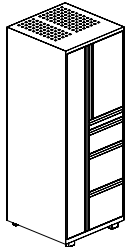
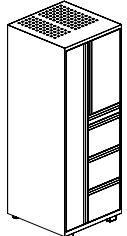
Description	Part number	Height	Width	Weight (lbs)	List price	Rectangular glides	Accent paint upcharge
 <p>Full-length door 14 1/4" wide on one side, 24" hinged door insert, 1-3" pencil, 1-7.5" box and 2-12" file drawers 13 5/8" wide on the other Optional Rectangular Glides</p>	GETL2458-PB7FF	64"	24"	—	\$3220	+\$28	+\$323
	GETL3058-PB7FF	64"	30"	—	\$3687	+\$28	+\$370
	left-handed hinged door (illustrated)						
	GETR2458-PB7FF	64"	24"	—	\$3220	+\$28	+\$323
	GETR3058-PB7FF	64"	30"	—	\$3687	+\$28	+\$370
	right-handed hinged door						
 <p>Full-length door 14 1/4" wide on one side, 24" hinged door insert, 1-3" pencil and 3-10.5" file drawers 13 5/8" wide on the other Optional Rectangular Glides</p>	GETL2458-P3F10	64"	24"	—	\$3220	+\$28	+\$323
	GETL3058-P3F10	64"	30"	—	\$3687	+\$28	+\$370
	left-handed hinged door (illustrated)						
	GETR2458-P3F10	64"	24"	—	\$3220	+\$28	+\$323
	GETR3058-P3F10	64"	30"	—	\$3687	+\$28	+\$370
	right-handed hinged door						

System

Storage

Towers

9900 Series Front Wardrobes

General information

- Option of mitten shelf with coat rod or shelves
- Use flat glides to match frame heights noted in descriptions
- Adding rectangular glides increases exterior height

Notes

In order to get a total cost on products when upcharges are present take the list price of the product number and add the upcharge cost shown to the list price.

For example:

Product INVR121852E-HD with Rectangular Glides would be \$1329 +\$28

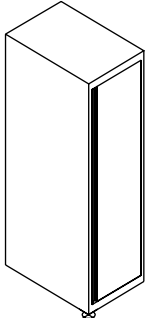
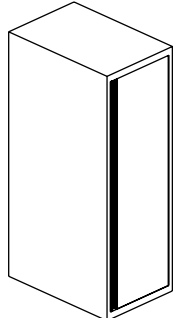
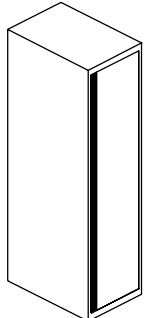
Description	Part number	Height	Width	Depth	Flat & round glides			
					Coat rod + shelf	Shelves	Rectangular glides	Accent paint upcharge
 <p>9900 Series Wardrobe Tower to match 44" h panel</p>	INVL121839E-HD	41 7/8"	12"	18"	\$1130	\$1130	+\$28	+\$114
	INVL122439E-HD	41 7/8"	12"	24"	\$1218	\$1218	+\$28	+\$122
	INVL151839E-HD	41 7/8"	15"	18"	\$1218	\$1218	+\$28	+\$122
	INVL152439E-HD	41 7/8"	15"	24"	\$1254	\$1254	+\$28	+\$126
	INVL181839E-HD	41 7/8"	18"	18"	\$1254	\$1254	+\$28	+\$126
	INVL182439E-HD	41 7/8"	18"	24"	\$1267	\$1267	+\$28	+\$127
	left-handed hinged door							
	INVR121839E-HD	41 7/8"	12"	18"	\$1130	\$1130	+\$28	+\$114
	INVR122439E-HD	41 7/8"	12"	24"	\$1218	\$1218	+\$28	+\$122
	INVR151839E-HD	41 7/8"	15"	18"	\$1218	\$1218	+\$28	+\$122
	INVR152439E-HD	41 7/8"	15"	24"	\$1254	\$1254	+\$28	+\$126
	INVR181839E-HD	41 7/8"	18"	18"	\$1254	\$1254	+\$28	+\$126
	INVR182439E-HD	41 7/8"	18"	24"	\$1267	\$1267	+\$28	+\$127
	right-handed hinged door (illustrated)							
 <p>9900 Series Wardrobe Tower to match 51" h panel</p>	INVL121846E-HD	49 3/8"	12"	18"	\$1222	\$1222	+\$28	+\$123
	INVL122446E-HD	49 3/8"	12"	24"	\$1290	\$1290	+\$28	+\$129
	INVL151846E-HD	49 3/8"	15"	18"	\$1290	\$1290	+\$28	+\$129
	INVL152446E-HD	49 3/8"	15"	24"	\$1362	\$1362	+\$28	+\$138
	INVL181846E-HD	49 3/8"	18"	18"	\$1362	\$1362	+\$28	+\$138
	INVL182446E-HD	49 3/8"	18"	24"	\$1434	\$1434	+\$28	+\$145
	left-handed hinged door							
	INVR121846E-HD	49 3/8"	12"	18"	\$1222	\$1222	+\$28	+\$123
	INVR122446E-HD	49 3/8"	12"	24"	\$1290	\$1290	+\$28	+\$129
	INVR151846E-HD	49 3/8"	15"	18"	\$1290	\$1290	+\$28	+\$129
	INVR152446E-HD	49 3/8"	15"	24"	\$1362	\$1362	+\$28	+\$138
	INVR181846E-HD	49 3/8"	18"	18"	\$1362	\$1362	+\$28	+\$138
	INVR182446E-HD	49 3/8"	18"	24"	\$1434	\$1434	+\$28	+\$145
	right-handed hinged door (illustrated)							
 <p>9900 Series Wardrobe Tower to match 57" h panel</p>	INVL121852E-HD	55 3/8"	12"	18"	\$1329	\$1329	+\$28	+\$133
	INVL122452E-HD	55 3/8"	12"	24"	\$1375	\$1375	+\$28	+\$139
	INVL151852E-HD	55 3/8"	15"	18"	\$1375	\$1375	+\$28	+\$139
	INVL152452E-HD	55 3/8"	15"	24"	\$1424	\$1424	+\$28	+\$144
	INVL181852E-HD	55 3/8"	18"	18"	\$1424	\$1424	+\$28	+\$144
	INVL182452E-HD	55 3/8"	18"	24"	\$1471	\$1471	+\$28	+\$148
	left-handed hinged door							
	INVR121852E-HD	55 3/8"	12"	18"	\$1329	\$1329	+\$28	+\$133
	INVR122452E-HD	55 3/8"	12"	24"	\$1375	\$1375	+\$28	+\$139
	INVR151852E-HD	55 3/8"	15"	18"	\$1375	\$1375	+\$28	+\$139
	INVR152452E-HD	55 3/8"	15"	24"	\$1424	\$1424	+\$28	+\$144
	INVR181852E-HD	55 3/8"	18"	18"	\$1424	\$1424	+\$28	+\$144
	INVR182452E-HD	55 3/8"	18"	24"	\$1471	\$1471	+\$28	+\$148
	right-handed hinged door (illustrated)							

General information

- Option of mitten shelf with coat rod or shelves
- Use flat glides to match frame heights noted in descriptions
- Adding rectangular glides increases exterior height

Notes

In order to get a total cost on products when upcharges are present take the list price of the product number and add the upcharge cost shown to the list price.

For example:

Product INVR121860E-HD with Rectangular Glides would be \$1358 +\$28

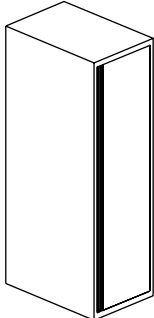
Description	Part number	Height	Width	Depth	Flat & round glides			
					Coat rod + shelf	Shelves	Rectangular glides	Accent paint upcharge
 <p>9900 Series Wardrobe Tower to match 64" h panel</p>	INVL121860E-HD	62 7/8"	12"	18"	\$1358	\$1358	+\$28	+\$137
	INVL122460E-HD	62 7/8"	12"	24"	\$1434	\$1434	+\$28	+\$145
	INVL151860E-HD	62 7/8"	15"	18"	\$1434	\$1434	+\$28	+\$145
	INVL152460E-HD	62 7/8"	15"	24"	\$1475	\$1475	+\$28	+\$149
	INVL181860E-HD	62 7/8"	18"	18"	\$1475	\$1475	+\$28	+\$149
	INVL182460E-HD left-handed hinged door	62 7/8"	18"	24"	\$1517	\$1517	+\$28	+\$153
	INVR121860E-HD	62 7/8"	12"	18"	\$1358	\$1358	+\$28	+\$137
	INVR122460E-HD	62 7/8"	12"	24"	\$1434	\$1434	+\$28	+\$145
	INVR151860E-HD	62 7/8"	15"	18"	\$1434	\$1434	+\$28	+\$145
	INVR152460E-HD	62 7/8"	15"	24"	\$1475	\$1475	+\$28	+\$149
	INVR181860E-HD	62 7/8"	18"	18"	\$1475	\$1475	+\$28	+\$149
	INVR182460E-HD right-handed hinged door (illustrated)	62 7/8"	18"	24"	\$1517	\$1517	+\$28	+\$153

System

Storage

Towers
Nuform Front Wardrobes

General information

- Option of mitten shelf with coat rod or shelves
- Use flat glides to match frame heights noted in descriptions
- Adding rectangular glides increases exterior height
- Consult General Information for pull options
- Woodgrain and solid colors available

Notes

Nuform Wardrobes are available with an eLock option. Add \$310 to list price for eLock.

In order to get a total cost on products when upcharges are present take the list price of the product number and add the upcharge cost shown to the list price.

For example:

Product INVR121852Q-HD with Rectangular Glides would be \$1595 +\$28

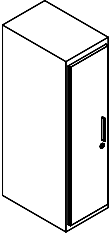
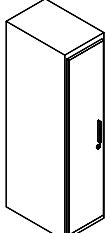
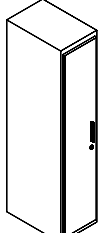
Description	Part number	Height	Width	Depth	Flat & round glides		Rectangular glides	Accent paint upcharge
					Coat rod + shelf	Shelves		
 <p>Nuform Wardrobe Tower to match 44" h panel eLock option available</p>	INVL121839Q-HD	41 7/8"	12"	18"	\$1358	\$1358	+\$28	+\$137
	INVL122439Q-HD	41 7/8"	12"	24"	\$1463	\$1463	+\$28	+\$148
	INVL151839Q-HD	41 7/8"	15"	18"	\$1463	\$1463	+\$28	+\$148
	INVL152439Q-HD	41 7/8"	15"	24"	\$1504	\$1504	+\$28	+\$152
	INVL181839Q-HD	41 7/8"	18"	18"	\$1504	\$1504	+\$28	+\$152
	INVL182439Q-HD	41 7/8"	18"	24"	\$1520	\$1520	+\$28	+\$153
	left-handed hinged door							
	INVR121839Q-HD	41 7/8"	12"	18"	\$1358	\$1358	+\$28	+\$137
	INVR122439Q-HD	41 7/8"	12"	24"	\$1463	\$1463	+\$28	+\$148
	INVR151839Q-HD	41 7/8"	15"	18"	\$1463	\$1463	+\$28	+\$148
	INVR152439Q-HD	41 7/8"	15"	24"	\$1504	\$1504	+\$28	+\$152
	INVR181839Q-HD	41 7/8"	18"	18"	\$1504	\$1504	+\$28	+\$152
	INVR182439Q-HD	41 7/8"	18"	24"	\$1520	\$1520	+\$28	+\$153
	right-handed hinged door (illustrated)							
 <p>Nuform Wardrobe Tower to match 51" h panel eLock option available</p>	INVL121846Q-HD	49 3/8"	12"	18"	\$1467	\$1467	+\$28	+\$148
	INVL122446Q-HD	49 3/8"	12"	24"	\$1547	\$1547	+\$28	+\$156
	INVL151846Q-HD	49 3/8"	15"	18"	\$1547	\$1547	+\$28	+\$156
	INVL152446Q-HD	49 3/8"	15"	24"	\$1632	\$1632	+\$28	+\$164
	INVL181846Q-HD	49 3/8"	18"	18"	\$1632	\$1632	+\$28	+\$164
	INVL182446Q-HD	49 3/8"	18"	24"	\$1722	\$1722	+\$28	+\$173
	left-handed hinged door							
	INVR121846Q-HD	49 3/8"	12"	18"	\$1467	\$1467	+\$28	+\$148
	INVR122446Q-HD	49 3/8"	12"	24"	\$1547	\$1547	+\$28	+\$156
	INVR151846Q-HD	49 3/8"	15"	18"	\$1547	\$1547	+\$28	+\$156
	INVR152446Q-HD	49 3/8"	15"	24"	\$1632	\$1632	+\$28	+\$164
	INVR181846Q-HD	49 3/8"	18"	18"	\$1632	\$1632	+\$28	+\$164
	INVR182446Q-HD	49 3/8"	18"	24"	\$1722	\$1722	+\$28	+\$173
	right-handed hinged door (illustrated)							
 <p>Nuform Wardrobe Tower to match 57" h panel eLock option available</p>	INVL121852Q-HD	55 3/8"	12"	18"	\$1595	\$1595	+\$28	+\$161
	INVL122452Q-HD	55 3/8"	12"	24"	\$1650	\$1650	+\$28	+\$166
	INVL151852Q-HD	55 3/8"	15"	18"	\$1650	\$1650	+\$28	+\$166
	INVL152452Q-HD	55 3/8"	15"	24"	\$1706	\$1706	+\$28	+\$171
	INVL181852Q-HD	55 3/8"	18"	18"	\$1706	\$1706	+\$28	+\$171
	INVL182452Q-HD	55 3/8"	18"	24"	\$1765	\$1765	+\$28	+\$177
	left-handed hinged door							
	INVR121852Q-HD	55 3/8"	12"	18"	\$1595	\$1595	+\$28	+\$161
	INVR122452Q-HD	55 3/8"	12"	24"	\$1650	\$1650	+\$28	+\$166
	INVR151852Q-HD	55 3/8"	15"	18"	\$1650	\$1650	+\$28	+\$166
	INVR152452Q-HD	55 3/8"	15"	24"	\$1706	\$1706	+\$28	+\$171
	INVR181852Q-HD	55 3/8"	18"	18"	\$1706	\$1706	+\$28	+\$171
	INVR182452Q-HD	55 3/8"	18"	24"	\$1765	\$1765	+\$28	+\$177
	right-handed hinged door (illustrated)							

General information

- Option of mitten shelf with coat rod or shelves
- Use flat glides to match frame heights noted in descriptions
- Adding rectangular glides increases exterior height.
- Consult General Information for pull options
- Woodgrain and solid colors available

Notes

Nuform Wardrobes are available with an eLock option. Add \$310 to list price for eLock.

In order to get a total cost on products when upcharges are present take the list price of the product number and add the upcharge cost shown to the list price.

**For example:
Product INVR121860Q-HD with Rectangular Glides would be \$1629 +\$28**

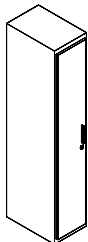
Description	Part number	Height	Width	Depth	Flat & round glides		Rectangular glides	Accent paint upcharge
					Coat rod + shelf	Shelves		
 <p>Nuform Wardrobe Tower to match 64" h panel eLock option available</p>	INVL121860Q-HD	62 7/8"	12"	18"	\$1629	\$1629	+\$28	+\$164
	INVL122460Q-HD	62 7/8"	12"	24"	\$1722	\$1722	+\$28	+\$173
	INVL151860Q-HD	62 7/8"	15"	18"	\$1722	\$1722	+\$28	+\$173
	INVL152460Q-HD	62 7/8"	15"	24"	\$1771	\$1771	+\$28	+\$178
	INVL181860Q-HD	62 7/8"	18"	18"	\$1771	\$1771	+\$28	+\$178
	INVL182460Q-HD left-handed hinged door	62 7/8"	18"	24"	\$1819	\$1819	+\$28	+\$183
	INVR121860Q-HD	62 7/8"	12"	18"	\$1629	\$1629	+\$28	+\$164
	INVR122460Q-HD	62 7/8"	12"	24"	\$1722	\$1722	+\$28	+\$173
	INVR151860Q-HD	62 7/8"	15"	18"	\$1722	\$1722	+\$28	+\$173
	INVR152460Q-HD	62 7/8"	15"	24"	\$1771	\$1771	+\$28	+\$178
	INVR181860Q-HD	62 7/8"	18"	18"	\$1771	\$1771	+\$28	+\$178
	INVR182460Q-HD right-handed hinged door (illustrated)	62 7/8"	18"	24"	\$1819	\$1819	+\$28	+\$183

Storage

Overhead storage General information

Overhead storage bins

Overhead storage bins may be panel mounted on or off module as well as wall mounted. Overhead bins are fabricated from minimum 20 gauge steel with horizontal reinforcing channels. Task lights and bin-mounted sorters are easily installed beneath bins without tools. Bins are available in 6" increments from 24" to 48" wide. General maximum recommended load for overhead bins is 3lbs per linear inch. Bins are finished in standard 37.5° gloss baked enamel, electrostatically applied in a 2-coat process and are available in all colors shown in the Inscape color guide.

Overhead bins are 13 3/8" deep and have lift-up flipper doors that glide on ball bearing slides. Soft-down bins feature a soft-down mechanism that slows the speed at which the overhead doors close. Bins are available with and without locks. The lock mechanism engages both sides of the overhead case to prevent forcible entry. Vertical sides of the Radius bin fronts are capped with black ABS plastic. Standard and soft-down overhead bins may be specified with Nuform woodgrain fronts. Woodgrain fronts are available in any of our standard woodgrain finishes. Soft-down bins may be specified with Veneer fronts.

Veneer bins

Veneer bins have a no pull option. These fronts do not have a pull as the bottom edge of the door hangs slightly below the bottom edge of the case, providing a natural pull feature for easy opening. For the no pull option add suffix '/FP000'.

Overhead bin brackets

Overhead bin brackets are finished in black and mount into the panel upright for on module bracket or utilize special brackets for off-module condition. Off-module brackets are specific to frame thickness. Specific Overhead Bin brackets are required for mounting onto a 44" and 57"h frame as well as 6.75" and 20.25"h stack-ons (on module).

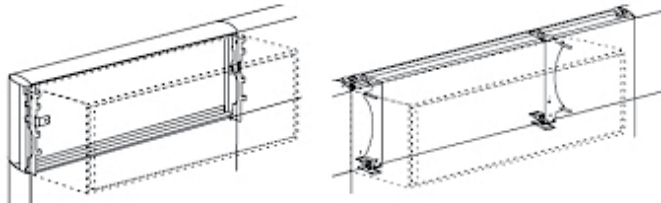

On module bracket

Off-module

Both brackets attach into upright slots on upright	Both brackets are mounted off module only
Does not require tile behind	Must be further than 5/16" from module line
	Requires tile behind

Alignment brackets

Alignment brackets are required if overhead storage units are mounted bin-to-bin or bin-to-shelf or shelf-to-shelf. One bracket is required.

Twin-bins

Twin-bins are 5.75" deep on each side of the supporting frame. Twin-Bins may be specified to install in both the lower and upper position of the frame. Bins are manufactured from minimum 20 gauge steel with an extruded aluminum reinforced top. Double wall, sliding doors on each side of the unit, slide easily across the recessed groove built into the bin front. Twin-Bins are available with or without locks. The locking mechanism is individualized for each side of the unit, allowing for personal privacy on either side. Twin-Bins are available in 36", 42", 48" and 60" widths. Recommended maximum load for Twin-Bins is 3lbs per linear inch. Bins are finished in standard 37.5° gloss baked enamel, electrostatically applied in a 2-coat process and are available in any of the colors shown in our Color Guide. Side pulls on Radius fronts are manufactured from ABS black plastic. Woodgrain fronts are available in any of our standard woodgrain finishes.

Handles are standard in aluminum finish and are located on the front of the sliding door. Case may still be ordered in any of the colors shown in our Color Guide.

Electrified twin bin

The electrified twin bin is built on the same premise as the standard Twin Bin with the addition of electrical and a sliding door with locking capabilities in two positions. All electrical components are specified separately including power track, receptacles and jumper cables. The sliding door may lock either the binder storage portion (full depth of bin) or the electrified portion which is the center portion which is approximately 5"d. The back of the Electrified Twin Bin may be clad with either a tackboard or whiteboard which are both specific to this storage unit. A shelf may also be optioned for the electrified portion which is field installed midway between top and bottom of opening. A gap in the shelf allows for the cord of an electronic unit to plug into duplex (located near base of opening) and still sit on top of shelf.

NOTE: these accessories are NOT compatible with the standard Twin Bin. See Application Guide for more details.

Specify Twin-Bin mounting brackets separately according to location on frame. 1 bracket per Twin-Bin is required. Specify 13.5" high bottom tiles when lower position mounting bracket is specified. When stacking Twin-Bins a 6.75" high tile minimum must separate the two. Do not specify over Power Track Kit. Twin-Bins specified with 44"H frames cannot be used above a worksurface. It is not recommended to specify Twin-Bins on wing panels. Twin-Bins should only be specified on spine panels for adequate stability.

Overhead shelves

Overhead Shelves may be panel-mounted both on and off-module or wall-mounted. Shelves are manufactured from minimum 20 gauge steel. Shelves are 13.75" deep.

Task lights and shelf-mounted sorters may easily be installed beneath panel-mounted shelves without tools. General maximum recommended load for overhead shelves is 3 lbs. per linear inch. Shelves are finished in standard 37.5° gloss baked enamel, electrostatically applied in a 2-coat process.

Overhead Shelf Brackets

Overhead Shelf Brackets are specified to mount shelf on or off-module to the frame. The on-module bracket may be used with either thickness of panel. If a shelf is desired in an off module condition a special bracket is required. Wall mount brackets are also available. Drywall mounting brackets do not include fasteners. The installer must ensure the surface is adequately constructed and/or braced and that adequate fasteners are used to ensure a secure installation.

Up-mount bin

The Up-Mount Bin is constructed of 24 gauge steel on the back and 20 gauge steel on bottom, sides and top. The Up-Mount Bin is ordered and shipped independent of the stanchion kit, top trim and accessories to hang on back of bin. The stanchion kit includes hardware to mount the stanchions on the crossrail of the frame and top trim (tapered or flat). Stanchion kits are specified based on thickness of frame in which the Up-Mount Bin is being installed. The backs of all Up-Mount Bins require either a whiteboard or a tackboard to provide a clean aesthetic. These accessories are specific to the Up-Mount Bin and include mounting hardware. The stanchion and Up-Mount Bin provide an overall height of 20.25" module matching adjacent panel heights. The bin is 12.75" deep and may be specified directly adjacent to another Up-Mount Bin facing the opposite direction; creating a "Twin-Bin" effect. Separate top cap and two stanchions will be required for each bin.

The Up-Mount Bin has the option to also be mounted on either thickness of frame like a traditional bin. When this option is selected covers will be included to hide the bracket hooks.

Locks

Standard with single bitted lock. If lock is not required add suffix '/NL' after product number and deduct \$48 list per lock. For applications requiring higher security a double bitted solution is available. Random keying is standard, and keyed alike may be ordered. Master keys are available; refer to the accessories section to specify.

Cabinets originally ordered as non-locking may be field installed with the addition of locking bars and a lock core. Contact your client services representative for required parts.

Locks feature removable core and are standard with two keys, one of which has a black neoprene plastic key cover. Locks may be ordered for field installation. Specify cabinet height and width or model number.







Note: Locks cannot be field installed on hinged door cabinets.

Finishes

All overhead units are finished in standard 36.5° gloss baked enamel, electrostatically applied in a 2-coat process. Refer to the surface materials section for available colors. With the exception of custom micas, whites and metallic; custom colors are available at an up-charge and are be subject to extended lead times. All interior drawers/shelf bodies, exposed hardware (excluding European style hinges) hang file bars, dividers and media frames are finished in Eco Black.

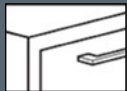
Front details & pull options

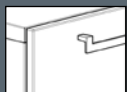
9900 Series fronts have full width integral pulls with enamel finish to match case fronts. 7900 is single-wall construction. Refer to the images and chart below for pull application on 7900 Series, Nuform, and Veneer fronts.

Pull	7900 Series	Nuform	Veneer
 FP001 P290 Aluminum Leaf Finish			
 FP002 Matte Chrome Finish			
 FP004 Brushed Nickel Finish			
 FP005 Satin Nickel Finish			
 FP007 Brushed Nickel Finish	+\$70	+\$70	+\$70
 FP008 Matte Chrome Finish	+\$70	+\$70	+\$70
 FP009 Nickel Plated Matte Finish	+\$70	+\$70	+\$70

Available Unavailable

Pulls FP004, FP005, FP007 and FP008 meet the guidelines for ADA compliance.

FP005 is the default pull for 7900

FP001 is the default pull for Nuform and Veneer

Note: FP002 is not available on hinged door cabinets.

System

Storage

Overhead Storage Storage Bins

General information

- Bracket ordered separately
- On module and aff module mounting options available
- Consult General Information for pull options
- Nuform woodgrain and solid colors available
- Cannot span tiles below overhead bins

Description	Part number	Height	Width	Weight (lbs)	Neutral paint/ base price	Accent paint upcharge
 7900 Series Front Standard Overhead Bin	INPHHB24	14"	24"	34	\$408	+\$42
	INPHHB30	14"	30"	40	\$418	+\$43
	INPHHB36	14"	36"	46	\$429	+\$44
	INPHHB42	14"	42"	52	\$455	+\$46
	INPHHB48	14"	48"	58	\$479	+\$49
 9900 Series Front Standard Overhead Bin	INPHEB24	14"	24"	34	\$479	+\$49
	INPHEB30	14"	30"	40	\$491	+\$50
	INPHEB36	14"	36"	46	\$504	+\$51
	INPHEB42	14"	42"	52	\$533	+\$54
	INPHEB48	14"	48"	58	\$565	+\$57
 9900 Series Front Soft-Down Overhead Bin	INPHEB24SD	14"	24"	34	\$590	+\$60
	INPHEB30SD	14"	30"	40	\$599	+\$60
	INPHEB36SD	14"	36"	46	\$620	+\$62
	INPHEB42SD	14"	42"	52	\$656	+\$66
	INPHEB48SD	14"	48"	58	\$692	+\$71
 Nuform Front Standard Overhead Bin	INPHQB24	14"	24"	34	\$682	+\$70
	INPHQB30	14"	30"	40	\$693	+\$71
	INPHQB36	14"	36"	46	\$716	+\$73
	INPHQB42	14"	42"	52	\$758	+\$77
	INPHQB48	14"	48"	58	\$798	+\$81
 Nuform Front Soft-Down Overhead Bin	INPHQB24SD	14"	24"	34	\$722	+\$74
	INPHQB30SD	14"	30"	40	\$747	+\$76
	INPHQB36SD	14"	36"	46	\$771	+\$78
	INPHQB42SD	14"	42"	52	\$796	+\$81
	INPHQB48SD	14"	48"	58	\$822	+\$83
 Composite Veneer Front Soft- Down Bin	INPHWB24SD	14"	24"	34	\$1051	+\$106
	INPHWB30SD	14"	30"	40	\$1124	+\$113
	INPHWB36SD	14"	36"	46	\$1198	+\$120
	INPHWB42SD	14"	42"	52	\$1270	+\$128
	INPHWB48SD	14"	48"	58	\$1343	+\$135

General information

- Hinged door bin is for wall mounted application only
- Hinged Door Bin options Nuform, laminate and veneer come with a lock. Options glass and acrylic do not
- Hinged door bins have a door that extends down a little bit below the bin so that it acts like a handle. no face mounted handle is required
- Up-Mount Bin may be installed on a wall or panel using wall or panel brackets
- If the option to panel mount the Up-Mount Bin is selected cover will be included to hide the bracket hooks
- Optional colored insert available for Up-Mount bin only. See accessories section
- Optional top available for Up-mount bin only. See accessories section
- When the Up-Mount Bin is being mounted on a wall, the optional Flush Mount Kit can be installed on bottom side of bin to cover understructure typically used for stanchion mount
- The Flush Mount Kit is not to be used when stanchion mounting to the bin

Lock Option

Hinged Door Overhead Bins come standard with lock. If lock is not required add suffix "/NL" after product number. Deduct \$48 list per lock.

Notes

Up-Mount Bins MUST always be specified to include a tack board or whiteboard specific to the up-mount bin width when installed on stanchion, as they cover holes on the back of the bin. See accessories section

If selecting the panel mounted option for the Up-Mount Bin, add \$94 list per bin.

In order to get a total cost on products when upcharges are present take the list price of the product number and add the upcharge cost shown to the list price.

For example:

Product INWMBHG24 in Veneer would be \$960 +\$156

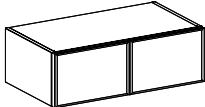
Description	Part number	Height	Width	Nuform & laminate	Grade 1 laminate	Veneer	Frosted glass	Frosted acrylic	Accent paint
	INWMBHG24	14"	24"	\$960	+\$308	+\$156	+\$408	+\$332	+\$97
	INWMBHG30	14"	30"	\$1012	+\$324	+\$182	+\$448	+\$357	+\$102

Hinged Door Bin

Description	Part number	Height	Width	Neutral paint/ base price	Flush bottom required	Accent paint
	UPMOUNT BIN					
	INPHUMB24	14"	24"	\$553	+\$97	+\$56
	INPHUMB30	14"	30"	\$572	+\$100	+\$58
	INPHUMB36	14"	36"	\$589	+\$103	+\$59
	INPHUMB42	14"	42"	\$617	+\$110	+\$62
	INPHUMB48	14"	48"	\$631	+\$116	+\$64
	INPHUMB54	14"	54"	\$658	+\$123	+\$66
	INPHUMB60	14"	60"	\$722	+\$130	+\$74

System







Storage

Overhead Storage

Storage Bin Brackets

General information

- Brackets are for use with both standard and soft-down bins
- On-module and off module brackets are black and ship as pairs
- Off-module brackets must be situated so both sides are off module on the frame (min 5/16" from module line)
- Wall mount bracket available in standard paint colors
- Alignment bracket must be specified when any overhead unit is specified adjacent to another
- "2F" denotes use with 2 3/4" thick frame
"3F" denotes use with 3 1/2" thick frame
- Specific Overhead Bin brackets are required for mounting onto a 44" and 57"h frame as well as 6.75" and 20.25"h stack-ons (on module)



Description	Part number	Width	Weight (lbs)	Neutral paint/ base price	Accent paint upcharge
 On Module Overhead Bin Bracket	INBBKT	—	0.2	\$47	—
	INBBKT-4457 for use with 44" H & 57" H frames	—	0.2	\$47	—
 Off Module Overhead Bin Bracket For use with 3 1/2" T frames	INOFBBKT-3F	—	0.2	\$138	—
 Off Module Overhead Bin Bracket For use with 2 3/4" T frames	INOFBBKT-2F	—	0.2	\$138	—
 Alignment Bracket (pair)	INAB	—	0.1	\$13	—
 Wall Mounted Bin Bracket	INWMBBKT-24	24"	2	\$228	+\$24
	INWMBBKT-30	30"	5	\$230	+\$24
	INWMBBKT-36	36"	5	\$232	+\$24
	INWMBBKT-42	42"	6	\$239	+\$25
	INWMBBKT-48	48"	6	\$242	+\$25
 ADDWALL Overhead Bin Bracket	INLHOHBBA	—	—	\$83	+\$10
	INRHOHBBA	—	—	\$83	+\$10
 Reform Overhead Bin Bracket	INBBKTR	—	—	\$83	—

General information

- Up-mount bins stanchions must be specified to support a frame mounted up-mount bin
- Top caps included with stanchion kits and are specified to match frame and bin width
- Stanchions are specific to the Inscope System frame and can not be used with Bench

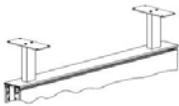
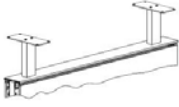
- “2F” denotes use with 2 ¾” thick frame
- “3F” denotes use with 3 ½” thick frame
- Specific Overhead Bin brackets are required for mounting onto a 44” and 57”h frame as well as 6.75” and 20.25”h stack-ons (on module)

Description	Part number	Height	Width	Weight (lbs)	Neutral paint/ base price	Accent paint upcharge
 Stanchion Kit for Up-Mount Bins For use with 3 ½” T frames	INUBSTNKT24-3F	5 ¼”	24”	—	\$308	+\$32
	INUBSTNKT30-3F	5 ¼”	30”	—	\$319	+\$33
	INUBSTNKT36-3F	5 ¼”	36”	—	\$326	+\$34
	INUBSTNKT42-3F	5 ¼”	42”	—	\$335	+\$34
	INUBSTNKT48-3F	5 ¼”	48”	—	\$342	+\$35
	INUBSTNKT54-3F	5 ¼”	54”	—	\$353	+\$36
	INUBSTNKT60-3F	5 ¼”	60”	—	\$363	+\$37
 Stanchion Kit for Up-Mount Bins For use with 2 ¾” T frames	INUBSTNKT24-2F	5 ¼”	24”	—	\$308	+\$32
	INUBSTNKT30-2F	5 ¼”	30”	—	\$319	+\$33
	INUBSTNKT36-2F	5 ¼”	36”	—	\$326	+\$34
	INUBSTNKT42-2F	5 ¼”	42”	—	\$335	+\$34
	INUBSTNKT48-2F	5 ¼”	48”	—	\$342	+\$35
	INUBSTNKT54-2F	5 ¼”	54”	—	\$353	+\$36
	INUBSTNKT60-2F	5 ¼”	60”	—	\$363	+\$37

Description	Part number	Width	Weight (lbs)	List price
 On Module Overhead Bin Bracket For use with the Up-Mount Bin on a 3 ½” T frame	INBBKTUP-3F	—	0.2	\$47
	INBBKTUP-3F4457 for use with 44” H & 57” H frames	—	0.2	\$47
 On Module Overhead Bin Bracket For use with the Up-Mount Bin on a 2 ¾” T frame	INBBKT	—	0.2	\$47
	INBBKT-4457 for use with 44” H & 57” H frames	—	0.2	\$47
 Alignment Bracket (pair)	INAB	—	0.1	\$13

System







Storage

Overhead Storage

Shelves + Brackets

General information

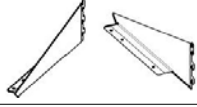
- On-module brackets are painted and ship as pairs
- "2F" denotes use with 2 ¾" thick frame
"3F" denotes use with 3 ½" thick frame
- Alignment bracket must be specified when any shelf is specified adjacent to another



Description	Part number	Height	Width	Weight (lbs)	Neutral paint/ base price	Accent paint upcharge
 13 ¾" D Standard Shelf	INPS1324	—	24"	4	\$62	+\$8
	INPS1330	—	30"	6	\$75	+\$9
	INPS1336	—	36"	8	\$79	+\$9
	INPS1342	—	42"	10	\$85	+\$10
	INPS1348	—	48"	12	\$89	+\$10
	INPS1354	—	54"	14	\$102	+\$11
	INPS1360	—	60"	16	\$110	+\$12
 On Module Standard Shelf Bracket For use with 3 ½" T frames	INSB13-3F	—	—	3	\$127	+\$14
 On Module Standard Shelf Bracket For use with 2 ¾" T frames	INSB13-2F	—	—	3	\$127	+\$14
 Wall Mount Standard Shelf Bracket	INSB1324W	—	24"	7	\$265	+\$28
	INSB1330W	—	30"	8	\$269	+\$28
	INSB1336W	—	36"	8	\$273	+\$28
	INSB1342W	—	42"	9	\$277	+\$29
	INSB1348W	—	48"	9	\$281	+\$29
 ADDWALL Shelf Bracket	INLHP13A	—	—	—	\$156	+\$17
 Reform Shelf Bracket	INSB13R	—	—	—	\$156	+\$17
 Alignment Bracket (pair)	INAB	—	—	0.1	\$13	—

General information

- Up-mount overhead bins MUST always be specified to include a tackboard or whiteboard specific to the up-mount bin width (cover holes in back) when mounted on stations
- Overhead bin top is an optional aesthetic
- ¾" top is installation ready, complete with double sided tape for adhesion to case

Note

Only Expo Markers are to be used on any Inscape Whiteboard. Whiteboards should be cleaned with Expo Eraser or a Microfiber cleaning cloth along with Expo Cleaning Solution which is formulated to remove residue from Expo Dry Erase Markers.

Description	Part number	Height	Width	Weight (lbs)	List price	Accent paint upcharge
 Colored Insert for back of bin For Up-Mounted bin only	IN12INSRT24	12 ½"	24"	—	\$90	+\$10
	IN12INSRT30	12 ½"	30"	—	\$94	+\$11
	IN12INSRT36	12 ½"	36"	—	\$100	+\$11
	IN12INSRT42	12 ½"	42"	—	\$104	+\$12
	IN12INSRT48	12 ½"	48"	—	\$110	+\$12
 Up-Mount Bin Whiteboard	INUBWHB1424	14"	24"	—	\$37	—
	INUBWHB1430	14"	30"	—	\$40	—
	INUBWHB1436	14"	36"	—	\$44	—
	INUBWHB1442	14"	42"	—	\$50	—
	INUBWHB1448	14"	48"	—	\$56	—
	INUBWHB1454	14"	54"	—	\$64	—
INUBWHB1460	14"	60"	—	\$66	—	

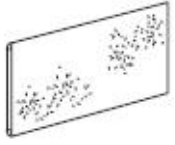
Description	Part number	Height	Width	Grade 1/ COM	Grade 2	Grade 3	Grade 4	Grade 5	Grade 6	Grade 7	Grade 8
 Up-Mount Bin Tackboard	INUBTAC1424	14"	24"	\$148	+\$5	+\$9	—	+\$24	—	+\$64	—
	INUBTAC1430	14"	30"	\$168	+\$4	+\$9	—	+\$24	—	+\$66	—
	INUBTAC1436	14"	36"	\$171	+\$9	+\$18	—	+\$36	—	+\$89	—
	INUBTAC1442	14"	42"	\$176	+\$10	+\$19	—	+\$37	—	+\$92	—
	INUBTAC1448	14"	48"	\$181	+\$10	+\$19	—	+\$40	—	+\$99	—
	INUBTAC1454	14"	54"	\$184	+\$9	+\$21	—	+\$39	—	+\$98	—
	INUBTAC1460	14"	60"	\$190	+\$7	+\$18	—	+\$38	—	+\$98	—

Description	Part number	Width	Depth	Nuform solid	Nuform woodgrain pattern
 ¾" T Up-Mount Bin Top	PHUMBTOP-1324	24"	13"	\$137	+\$16
	PHUMBTOP-1330	30"	13"	\$162	+\$16
	PHUMBTOP-1336	36"	13"	\$192	+\$13
	PHUMBTOP-1342	42"	13"	\$212	+\$23
	PHUMBTOP-1348	48"	13"	\$235	+\$25
	PHUMBTOP-1354	54"	13"	\$259	+\$26
	PHUMBTOP-1360	60"	13"	\$284	+\$29
	PHUMBTOP-1372	72"	13"	\$373	+\$37
	PHUMBTOP-1384	84"	13"	\$417	+\$40
	PHUMBTOP-1396	96"	13"	\$458	+\$46

System



Storage

Overhead Storage

Up-Mount Bin Accessories

General information

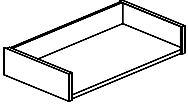

- Up-Mount shelf mounts below the Up-Mount Bin on module
- Wall mount bracket available in standard paint colors
- Sliding door must be mounted on two up-mount bins of equal size that are side by side

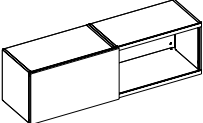
Description	Part number	Height	Width	Weight (lbs)	Neutral paint/ base price	Accent paint upcharge
	Up-Mount Bin shelf					
	INUMBSH24	4 1/8"	24"	—	\$264	+\$27
	INUMBSH30	4 1/8"	30"	—	\$269	+\$28
	INUMBSH36	4 1/8"	36"	—	\$273	+\$28
	INUMBSH42	4 1/8"	42"	—	\$299	+\$31
	INUMBSH48	4 1/8"	48"	—	\$308	+\$32
	Wall Mounted Bin Bracket					
	INWMBBKT-24	—	24"	2	\$228	+\$24
	INWMBBKT-30	—	30"	5	\$230	+\$24
	INWMBBKT-36	—	36"	5	\$232	+\$24
	INWMBBKT-42	—	42"	6	\$239	+\$25
	INWMBBKT-48	—	48"	6	\$242	+\$25

Description	Part number	Width	Nufrom & laminate	Grade 1 laminate	Veneer
	Sliding Door & Track				
	Up-Mount bin specified separately				
	INUMBSLDR24	24"	\$384	+\$123	+\$138
	INUMBSLDR30	30"	\$491	+\$158	+\$135
	INUMBSLDR36	36"	\$505	+\$162	+\$165
	INUMBSLDR42	42"	\$513	+\$165	+\$196
	INUMBSLDR48	48"	\$527	+\$169	+\$223

General information

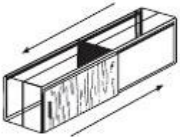
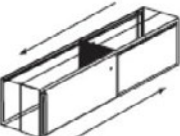
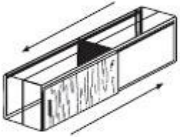
- Requires a 13.5" opening within either thickness of frame
- Twin-Bin cannot be installed directly above a worksurface as it causes interference
- Twin-Bin brackets are quoted separately and are specific to panel thickness
- Cannot span tiles below twin-bins
- Upperdeck electrical cannot be installed directly below a twin-bin
- Jumper cables and receptacles for the Electrified Twin Bin power track specified separately
- The "IN3D_-UD-8" receptacles are to be specified in conjunction with the Electrified Twin-Bin

Description	Part number	Height	Width	Weight (lbs)	List price	Accent paint
 Nuform Front Twin-Bin	INTWQB36LH	14"	36"	42	\$1263	+\$127
	INTWQB42LH	14"	42"	52	\$1313	+\$132
	INTWQB48LH	14"	48"	58	\$1359	+\$137
	INTWQB54LH	14"	54"	62	\$1374	+\$139
	INTWQB60LH	14"	60"	68	\$1390	+\$140
 Radius Front Twin-Bin	INTWRB36LH	14"	36"	42	\$1133	+\$114
	INTWRB42LH	14"	42"	52	\$1175	+\$118
	INTWRB48LH	14"	48"	58	\$1218	+\$122
	INTWRB54LH	14"	54"	62	\$1236	+\$124
	INTWRB60LH	14"	60"	68	\$1249	+\$125
 Composite Veneer Front Twin-Bin	INTWVB36LH	14"	36"	42	\$1944	+\$195
	INTWVB42LH	14"	42"	52	\$2002	+\$201
	INTWVB48LH	14"	48"	58	\$2112	+\$212
	INTWVB54LH	14"	54"	62	\$2272	+\$228
	INTWVB60LH	14"	60"	68	\$2556	+\$256
 Nuform Front Electrified Twin-Bin	INETWBQ36	14"	36"	42	\$1645	+\$165
	INETWBQ42	14"	42"	52	\$1722	+\$173
	INETWBQ48	14"	48"	58	\$1766	+\$177
	INETWBQ54	14"	54"	62	\$1786	+\$179
	INETWBQ60	14"	60"	68	\$1806	+\$181
 Composite Veneer Front Electrified Twin-Bin	INETWBV36	14"	36"	42	\$2526	+\$253
	INETWBV42	14"	42"	52	\$2630	+\$264
	INETWBV48	14"	48"	58	\$2778	+\$279
	INETWBV54	14"	54"	62	\$2954	+\$296
	INETWBV60	14"	60"	68	\$3339	+\$334

System







Storage

Overhead Storage

Twin-Bin Brackets

General information

- The mid and lower brackets include crossrails which are required for installation of Twin-Bin
- Frame crossrail is required to be cut on site to install the mid Twin-Bin bracket
- See Inscape System Application Guide for bracket details and locations
- Twin-Bin brackets are specific to frame thickness
- “2F” denotes use with 2.75” thick frame,
“3F” denotes use with 3.5” thick frame

Description	Part number	Height	Width	Weight (lbs)	List price
 Upper Twin-Bin Bracket For use with 3 ½” T frames	INTWBKT-U-3F	—	—	0.4	\$98
 Mid Twin-Bin Bracket For use with 3 ½” T frames	INTWBKTUH-36-3F	—	36”	—	\$154
	INTWBKTUH-42-3F	—	42”	—	\$156
	INTWBKTUH-48-3F	—	48”	—	\$159
	INTWBKTUH-54-3F	—	54”	—	\$161
	INTWBKTUH-60-3F	—	60”	—	\$163
 Lower Twin-Bin Bracket For use with 3 ½” T frames	INTWBKT-B-36-3F	—	36”	—	\$154
	INTWBKT-B-42-3F	—	42”	—	\$156
	INTWBKT-B-48-3F	—	48”	—	\$159
	INTWBKT-B-54-3F	—	54”	—	\$161
	INTWBKT-B-60-3F	—	60”	—	\$163
 Upper Twin-Bin Bracket For use with 2 ¾” T frames	INTWBKT-U-2F	—	—	0.4	\$98
 Mid Twin-Bin Bracket For use with 2 ¾” T frames	INTWBKTUH-36-2F	—	36”	—	\$154
	INTWBKTUH-42-2F	—	42”	—	\$156
	INTWBKTUH-48-2F	—	48”	—	\$159
	INTWBKTUH-54-2F	—	54”	—	\$161
	INTWBKTUH-60-2F	—	60”	—	\$163
 Lower Twin-Bin Bracket For use with 2 ¾” T frames	INTWBKT-B-36-2F	—	36”	—	\$154
	INTWBKT-B-42-2F	—	42”	—	\$156
	INTWBKT-B-48-2F	—	48”	—	\$159
	INTWBKT-B-54-2F	—	54”	—	\$161
	INTWBKT-B-60-2F	—	60”	—	\$163

General information

- Electrified Twin Bin shelf is installed in opening where electrical is located (center)
- Electrified Twin Bin Whiteboard + Tackboard only compatible with Electrified Twin Bin
- Receptacles are available in color options of black (default), white and gray
- White close match to 168 Glacier White and Gray close match to 290 – Aluminum Leaf
- The circuit 3 receptacle requires 2+2 or 3+1 wire designation (“4” in the code signifies 3+1 compatibility)
- USB power modules can be used with the Electrified Twin-Bin

Note

Only Expo Markers are to be used on any Inscape Whiteboard. Whiteboards should be cleaned with Expo Eraser or a Microfiber cleaning cloth along with Expo Cleaning Solution which is formulated to remove residue from Expo Dry Erase Markers.

Description	Part number	Height	Width	Grade 1/ COM	Grade 2	Grade 3	Grade 4	Grade 5	Grade 6	Grade 7	Grade 8
	Electrified Twin-Bin Tackboard										
	INTWBTB-12	14"	12"	\$112	+\$5	+\$12	—	+\$24	—	+\$64	—
	INTWBTB-14	14"	14"	\$115	+\$5	+\$12	—	+\$24	—	+\$64	—
	INTWBTB-16	14"	16"	\$120	+\$5	+\$12	—	+\$24	—	+\$64	—
	INTWBTB-18	14"	18"	\$126	+\$5	+\$12	—	+\$24	—	+\$64	—
	INTWBTB-20	14"	20"	\$137	+\$5	+\$12	—	+\$24	—	+\$64	—

Description	Part number	Height	Width	Weight (lbs)	List price	Accent paint
	Electrified Twin-Bin Shelf					
	INETWBSHF-12	—	12"	—	\$91	+\$10
	INETWBSHF-14	—	14"	—	\$91	+\$10
	INETWBSHF-16	—	16"	—	\$91	+\$10
	INETWBSHF-18	—	18"	—	\$91	+\$10
	INETWBSHF-20	—	20"	—	\$91	+\$10

Description	Part number	Height	Width	Weight (lbs)	List price	Accent paint
	Electrified Twin-Bin Whiteboard					
	INTWBWB-12	14"	12"	—	\$33	—
	INTWBWB-14	14"	14"	—	\$33	—
	INTWBWB-16	14"	16"	—	\$33	—
	INTWBWB-18	14"	18"	—	\$37	—
	INTWBWB-20	14"	20"	—	\$37	—

Description	Part number	Height	Width	Weight (lbs)	List price	Accent paint
	INETPTWB-8	—	8"	—	\$75	—

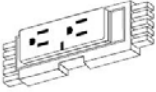
Description	Part number	Black	White	Gray
	Receptacle for use in Electrified Twin-Bin			
	IN3D1-UD-8	\$23	+\$8	+\$8
	IN3D2-UD-8	\$23	+\$8	+\$8
	IN3D3-UD-8	\$23	+\$8	+\$8
	IN3D3U-UD-8	\$23	+\$8	+\$8
	IN3D4-UD-8	\$23	+\$8	+\$8

System

Storage

Planna Storage General Information

Planna Storage exterior cabinet heights are nominal, interior case height is 21". Lateral and pedestal options are available. Units include mounting rails (see Inscape System Application Guide) that are pre-installed by the factory to accommodate the Planna Storage lateral top which is specified separately (see Accessories section). These mounting rails are ready to accept application of this lateral top on site. Bench support bracket must also be specified separately. Lateral cabinets are priced inclusive of one pair of hang file bars in each 10.5" and 12" pull out openings.

ANSI/BIFMA

With the addition of counterweights where appropriate, cabinets meet all BIFMA specifications.

Counterweights

Counterweights are required for ALL freestanding units that are not anchored or ganged to other cabinets or bolted to walls/floor.

Counterweights come standard with ALL mobile pedestals and must be field installed.

Glides

Planna units are standard with flat glides. Glides allow for 5/8" height adjustability.

Locks

Cabinets come standard with lock. 9900 series cabinets can be ordered non-locking.

Bookcase cabinets come standard without locks.

Standard with single bitted lock. If lock is not required add suffix '**NL**' after product number and deduct \$48 list per lock. For applications requiring higher security a double bitted solution is available. Random keying is standard, and keyed alike may be ordered. Master keys are available; refer to the accessories section to specify.

Cabinets originally ordered as non-locking may be field installed with the addition of locking bars and a lock core. Contact your client services representative for required parts.

Locks feature removable core and are standard with two keys, one of which has a black neoprene plastic key cover. Locks may be ordered for field installation. Specify cabinet height and width or model number.

Note: Locks cannot be field installed on hinged door cabinets.







9900 Series Note: Pedestals with 9900 series fronts must be specified beneath Wood Veneer and 1" Nuform worksurfaces only.

Finishes

All units are finished in standard 36.5° gloss baked enamel, electrostatically applied in a 2-coat process. Refer to the surface materials section for available colors. With the exception of custom micas, whites and metallic; custom colors are available at an up-charge and are be subject to extended lead times. All interior drawers/ shelf bodies, exposed hardware (excluding European style hinges) hang file bars, dividers and media frames are finished in Eco Black.

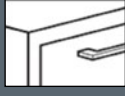
Front details & pull options

9900 Series fronts have full width integral pulls with enamel finish to match case fronts. Refer to the images and chart below for pull application on Nuform, and Veneer fronts.

Pull	Nuform	Veneer
 <p>FP001 P290 Aluminum Leaf Finish</p>		
 <p>FP002 Matte Chrome Finish</p>		
 <p>FP004 Brushed Nickel Finish</p>		
 <p>FP005 Satin Nickel Finish</p>		
 <p>FP007 Brushed Nickel Finish</p>	+\$70	+\$70
 <p>FP008 Matte Chrome Finish</p>	+\$70	+\$70
 <p>FP009 Nickel Plated Matte Finish</p>	+\$70	+\$70

Available

Unavailable

Pulls FP004, FP005, FP007 and FP008 meet the guidelines for ADA compliance.

FP001 is the default pull for Nuform & Veneer







Note: FP002 is not available on hinged door cabinets.

General information

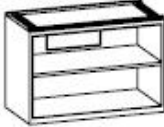
- Planna Storage case comes with optional Planna Storage rail
- **DO NOT option yes for rail if mounting a cushion on the case**
- **When "no rail" is optioned there will still be mounting holes in the top of the case. Cover with cushion or common top**
- 18"d lateral case
- Height noted below includes 1/2" Planna Storage rail. Adding a Planna common top will add an additional 1/2"
- FP001 pull is standard for Nuform and veneer fronts
- Consult General Information for pull options

Note

- If Planna Storage rail is not required deduct the following:**
30" W unit deduct \$135
36" W unit deduct \$140
42" W unit deduct \$145

Description	Part number	Height	Width	Weight (lbs)	Neutral paint/ base price	Accent paint upcharge	
	Bookcase with 1 shelf	PLN3021BK-SH	24 3/8"	30"	59	\$929	+\$94
		PLN3621BK-SH	24 3/8"	36"	69	\$971	+\$98
		PLN4221BK-SH	24 3/8"	42"	79	\$1032	+\$104
	Bookcase with Electrical Cut Out	PLN3021BKCO-SH	24 3/8"	30"	59	\$1144	+\$115
		PLN3621BKCO-SH	24 3/8"	36"	69	\$1179	+\$119
		PLN4221BKCO-SH	24 3/8"	42"	79	\$1222	+\$123
	Bookcase with Electrical Cut Out and Drop Down Hinge Door	PLN3021BKOPDM	24 3/8"	30"	62	\$1324	+\$133
		PLN3621BKOPDM	24 3/8"	36"	72	\$1369	+\$138
		PLN4221BKOPDM	24 3/8"	42"	82	\$1425	+\$144
	Bookcase with Magazine Shelf	PLN3021-SHMS	24 3/8"	30"	59	\$957	+\$97
		PLN3621-SHMS	24 3/8"	36"	69	\$999	+\$101
		PLN4221-SHMS	24 3/8"	42"	79	\$1051	+\$106
	9900 Series Front 2-10.5" files	PLN30-2F10E	24 3/8"	30"	80	\$1092	+\$110
		PLN36-2F10E	24 3/8"	36"	90	\$1136	+\$114
		PLN42-2F10E	24 3/8"	42"	116	\$1179	+\$119
	Nuform Front 2-10.5" files	PLN30-2F10Q	24 3/8"	30"	80	\$1353	+\$137
		PLN36-2F10Q	24 3/8"	36"	90	\$1410	+\$142
		PLN42-2F10Q	24 3/8"	42"	116	\$1467	+\$148
	Composite Veneer Front 2-10.5" files	PLN30-2F10W	24 3/8"	30"	80	\$2073	+\$209
		PLN36-2F10W	24 3/8"	36"	90	\$2136	+\$215
		PLN42-2F10W	24 3/8"	42"	116	\$2182	+\$219
	9900 Series Front 3" pencil, 6" box, 12" file	PLN30-PBFE	24 3/8"	30"	80	\$1210	+\$122
		PLN36-PBFE	24 3/8"	36"	90	\$1255	+\$126
		PLN42-PBFE	24 3/8"	42"	116	\$1298	+\$130
	9900 Series Front 3" pencil, 7.5" box, 10.5" file	PLN30-PB7F10E	24 3/8"	30"	80	\$1155	+\$116
		PLN36-PB7F10E	24 3/8"	36"	90	\$1203	+\$121
		PLN42-PB7F10E	24 3/8"	42"	116	\$1236	+\$124

System

Storage





Planna Storage
Base Modules Lateral

General information

- Planna Storage case comes with optional Planna Storage rail
- **DO NOT option yes for rail if mounting a cushion on the case**
- **When "no rail" is optioned there will still be mounting holes in the top of the case. Cover with cushion or common top**
- 18"d lateral case
- Height noted below includes ½" Planna Storage rail. Adding a Planna common top will add an additional ½"
- FP001 pull is standard for Nuform and veneer fronts
- Consult General Information for pull options

Note

- If Planna Storage rail is not required deduct the following:**
30" W unit deduct \$135
36" W unit deduct \$140
42" W unit deduct \$145

Description	Part number	Height	Width	Weight (lbs)	Neutral paint/ base price	Accent paint upcharge	
	9900 Series Front 4.5" box, 6" box, 10.5" file	PLN30-B4BF10E	24 ¾"	30"	80	\$1155	+\$116
		PLN36-B4BF10E	24 ¾"	36"	90	\$1203	+\$121
		PLN42-B4BF10E	24 ¾"	42"	116	\$1236	+\$124
	9900 Series Front 6" box, bookcase	PLN3021-BBKE	24 ¾"	30"	70	\$1218	+\$122
		PLN3621-BBKE	24 ¾"	36"	85	\$1269	+\$127
		PLN4221-BBKE	24 ¾"	42"	100	\$1322	+\$133
	9900 Series Front Bookcase, 10.5" file	PLN3021-BKF10E	24 ¾"	30"	70	\$1204	+\$121
		PLN3621-BKF10E	24 ¾"	36"	90	\$1247	+\$125
		PLN4221-BKF10E	24 ¾"	42"	100	\$1298	+\$130
	9900 Series Front 3" pencil, bookcase	PLN3021-PBKE	24 ¾"	30"	70	\$1156	+\$116
		PLN3621-PBKE	24 ¾"	36"	85	\$1205	+\$121
		PLN4221-PBKE	24 ¾"	42"	100	\$1257	+\$126

General information

- Planna Storage case comes with optional Planna Storage rail
- **DO NOT option yes for rail if mounting a cushion on the case**
- **When "no rail" is optioned there will still be mounting holes in the top of the case. Cover with cushion or common top**
- 18"d lateral case
- height noted below includes ½" Planna Storage rail. Adding a Planna common top will add an additional ½"
- FP001 pull is standard for acrylic, Nuform and veneer fronts
- Consult General Information for pull options





Note

If Planna Storage rail is not required deduct the following:

30" W unit deduct \$135

36" W unit deduct \$140

42" W unit deduct \$145

Description	Part number	Height	Width	Weight (lbs)	Neutral paint/ base price	Accent paint upcharge
 9900 Series Front Hinged Door with 1 Shelf	PLN3021HDE-SH	24 ¾"	30"	57	\$1099	+\$111
	PLN3621HDE-SH	24 ¾"	36"	76	\$1109	+\$112
	PLN4221HDE-SH	24 ¾"	42"	95	\$1146	+\$115
 Frosted Acrylic Hinged Door with 1 Shelf	PLN3021HDJ-SH	24 ¾"	30"	57	\$1751	+\$176
	PLN3621HDJ-SH	24 ¾"	36"	76	\$1860	+\$187
	PLN4221HDJ-SH	24 ¾"	42"	95	\$1983	+\$199
 Nuform Front Hinged Door with 1 Shelf	PLN3021HDQ-SH	24 ¾"	30"	57	\$1298	+\$130
	PLN3621HDQ-SH	24 ¾"	36"	76	\$1344	+\$135
	PLN4221HDQ-SH	24 ¾"	42"	95	\$1391	+\$140
 Composite Veneer Front Hinged Door with 1 Shelf	PLN3021HDW-SH	24 ¾"	30"	57	\$1756	+\$176
	PLN3621HDW-SH	24 ¾"	36"	76	\$1892	+\$190
	PLN4221HDW-SH	24 ¾"	42"	95	\$2080	+\$209

System

Storage





Planna Storage
Base Modules Pedestal

General information

- Planna Storage case comes with optional Planna Storage rail
- **DO NOT option yes for rail if mounting a cushion on the case**
- **When "no rail" is optioned there will still be mounting holes in the top of the case. Cover with cushion or common top**
- 15" w pedestal case
- Height noted below includes ½" Planna Storage rail. Adding a Planna common top will add an additional ½"
- FP001 pull is standard for Nuform and veneer fronts
- Consult General Information for pull options

Note

If Planna Storage rail is not required deduct the following:
18" D unit deduct \$131
22" D unit deduct \$135
28" D unit deduct \$140

Description	Part number	Height	Width	Weight (lbs)	Neutral paint/ base price	Accent paint upcharge	
	9900 Series Front 2-10.5" files	PLN1518E-2F10.5	24 ¾"	18"	75	\$841	+\$85
		PLN1522E-2F10.5	24 ¾"	22"	85	\$903	+\$91
		PLN1528E-2F10.5	24 ¾"	28"	95	\$934	+\$94
	9900 Series Front 3" pencil, 6" box, 12" file	PLN1518E-PBF	24 ¾"	18"	75	\$887	+\$90
		PLN1522E-PBF	24 ¾"	22"	85	\$978	+\$99
		PLN1528E-PBF	24 ¾"	28"	95	\$1023	+\$103
	Nuform Front 2-10.5" file	PLN1518Q-2F10.5	24 ¾"	18"	75	\$1126	+\$113
		PLN1522Q-2F10.5	24 ¾"	22"	85	\$1181	+\$119
		PLN1528Q-2F10.5	24 ¾"	28"	95	\$1334	+\$134
	Composite Veneer Front 2-10.5" files	PLN1518W-2F10.5	24 ¾"	18"	75	\$1424	+\$144
		PLN1522W-2F10.5	24 ¾"	22"	85	\$1472	+\$148
		PLN1528W-2F10.5	24 ¾"	28"	95	\$1605	+\$162

General information

- Install on case where adjacent case is same width, allows for sliding door to cover both cases
- Sliding doors are handed and should be ordered based on direction of slide to open door
- Pull includes a 2" silver pull detail in upper quadrant of doors edge
- Sliding door must be mounted on two up-mount bins of equal size that are side by side

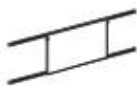
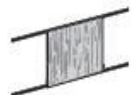
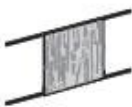
Description	Part number	Height	Width	Weight (lbs)	Neutral paint/ base price	Accent paint upcharge
	Nuform Solid Sliding Door					
	SWBL3021SDS	25 3/4"	30"	8	\$562	+\$57
	SWBL3621SDS	25 3/4"	36"	10	\$604	+\$61
	SWBL4221SDS	25 3/4"	42"	11	\$641	+\$65
	left-handed					
	SWBR3021SDS	25 3/4"	30"	8	\$562	+\$57
SWBR3621SDS	25 3/4"	36"	10	\$604	+\$61	
SWBR4221SDS	25 3/4"	42"	11	\$641	+\$65	
	right-handed (illustrated)					
	Nuform Woodgrain Sliding Door					
	SWBL3021SDQ	25 3/4"	30"	8	\$562	+\$57
	SWBL3621SDQ	25 3/4"	36"	10	\$604	+\$61
	SWBL4221SDQ	25 3/4"	42"	11	\$641	+\$65
	left-handed					
	SWBR3021SDQ	25 3/4"	30"	8	\$562	+\$57
SWBR3621SDQ	25 3/4"	36"	10	\$604	+\$61	
SWBR4221SDQ	25 3/4"	42"	11	\$641	+\$65	
	right-handed (illustrated)					
	Veneer Sliding Door					
	SWBL3021SDW	25 3/4"	30"	8	\$1198	+\$120
	SWBL3621SDW	25 3/4"	36"	10	\$1118	+\$113
	SWBL4221SDW	25 3/4"	42"	11	\$1054	+\$106
	left-handed					
	SWBR3021SDW	25 3/4"	30"	8	\$1198	+\$120
SWBR3621SDW	25 3/4"	36"	10	\$1118	+\$113	
SWBR4221SDW	25 3/4"	42"	11	\$1054	+\$106	
	right-handed (illustrated)					





System

Storage

Planna Storage
Benching End Trim

General information

- Includes mounting hardware to attach to the adjacent Planna Storage cases
- 3.5" thick version only
- Specific for worksurface or cushion above
- Specific whether a cut out is required to allow electrical feed and data cabling to enter frame behind

Description	Part number	Height	Width	Weight (lbs)	Neutral paint/ base price	Accent paint upcharge
 <p>End Trim with Electrical Cutout, Worksurface compatible (worksurface above)</p>	PLNCETCO	25"	3.5"	2	\$78	+\$9
 <p>End Trim without Cutout / Private Office Case Back Filler, Worksurface compatible (worksurface above)</p>	PLNCET	25"	3.5"	2	\$75	+\$9
 <p>End Trim with Electrical Cutout, Cushion compatible (cushion above)</p>	PLNCETCOCUSH	25"	3.5"	2	\$63	+\$8
 <p>End Trim without Cutout / Private Office Case Back Filler, Cushion compatible (cushion above)</p>	PLNCETCUSH	25"	3.5"	2	\$59	+\$7
 <p>6.75" H Painted Multi Access Tile for use with Planna Storage</p>	INPL6.75MAP30	6.75"	30"	4	\$90	+\$10
	INPL6.75MAP36	6.75"	36"	5	\$93	+\$11
	INPL6.75MAP42	6.75"	42"	6	\$99	+\$11

Storwal Storage is a workplace alternative that supports collaborative and independent work styles in open plans with or without panels. An intelligent alternative to conventional panel-based systems, Inscape System's Storwal Storage addresses technology, workplace design and facility needs. Storwal Storage is comprised of static and movable components for a wide range of modifications in open office plans. Storwal Storage double sided storage wall with desk height lay in cabling provides easy access to upper deck voice/data/power. Stack units are installed on top of base modules which include a technology zone. Three overall heights are achieved by the various stack units.

Base module

Exterior cabinet heights are nominal. includes a 4 3/4" high electrical module.

Electrical zone

4 3/4" high electrical zone contains four hooks to manage data cables. 30" wide module has one electrical outlet. 36" and 42" wide electrical modules have two electrical cut outs. See chart below for capacity information.

	CAT5	CAT6
Storwal – Hooks (40%)	25 ¹	19 ¹
Storwal – Hooks (full capacity)	64 ²	49 ²
Storwal – Full Cavity	153 ²	118 ²

¹40% Fill Capacity based on ceiling feed entry.

²Full capacity of hooks and/or electrical zone based on base feed entry.

Glides

Standard with Storwal Glides. Rectangular glides are an option. Glides provide 0.75" height adjustment.

Locks

Standard with single bitted lock. 9900 series cabinets can be ordered non-locking. Bookcase cabinets come standard without locks. If lock is not required add suffix '/NL' after product number and deduct \$48 list per lock. For applications requiring higher security a double bitted solution is available. Random keying is standard, and keyed alike may be ordered. Master keys are available; refer to the accessories section to specify.

Cabinets originally ordered as non-locking may be field installed with the addition of locking bars and a lock core. Contact your client services representative for required parts.

Locks feature removable core and are standard with two keys, one of which has a black neoprene plastic key cover. Locks may be ordered for field installation. Specify cabinet height and width or model number.





Note: Locks cannot be field installed on hinged door cabinets.

Finishes

Cabinets, 9900 series fronts and electrical module are available in standard colors, 5 textured finishes and custom colors. Fronts are also available in Nuform Woodgrain and Veneer options with aluminum finished handle. Drawer bodies and accessories are finished in Eco Black.

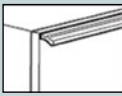
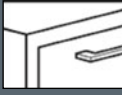
Front details & pull options

9900 Series fronts have full width integral pulls with enamel finish to match case fronts. Refer to the images and chart below for pull application on Nuform, and Veneer fronts.

Pull	Nuform	Veneer
 FP001 P290 Aluminum Leaf Finish		
 FP002 Matte Chrome Finish		
 FP004 Brushed Nickel Finish		
 FP005 Satin Nickel Finish		
 FP007 Brushed Nickel Finish	+\$70	+\$70
 FP008 Matte Chrome Finish	+\$70	+\$70
 FP009 Nickel Plated Matte Finish	+\$70	+\$70

Available Unavailable

Pulls FP004, FP005, FP007 and FP008 meet the guidelines for ADA compliance.

FP001 is the default pull for Nuform & Veneer

Note: FP002 is not available on hinged door cabinets.

System

Storage

Storwal Storage

Base Modules Open Bookcase

General information



- Base unit includes ganging hardware to gang adjacent Storwal storage units together
- Under Worksurface base module provides cut out for electrical on same side as open bookcase

Notes

In order to get a total cost on products when upcharges are present take the list price of the product number and add the upcharge cost shown to the list price.

For example:

Product SWB3024BK-SH with Rectangular Glides would be \$1215 +\$28

Description	Part number	Height	Width	Weight (lbs)	Round glides/ base price	Rectangular glides	Accent paint upcharge	
	Open Bookcase with 1 adjustable shelf	SWB3024BK-SH	33 1/8"	30"	69	\$1215	+\$28	+\$122
		SWB3624BK-SH	33 1/8"	36"	79	\$1275	+\$28	+\$128
	Receptical openings on rear	SWB4224BK-SH	33 1/8"	42"	89	\$1328	+\$28	+\$133
	Open Bookcase with 1 adjustable shelf	SWB3024BK-SH-R	33 1/8"	30"	69	\$1215	+\$28	+\$122
		SWB3624BK-SH-R	33 1/8"	36"	79	\$1275	+\$28	+\$128
	Receptical openings on front	SWB4224BK-SH-R	33 1/8"	42"	89	\$1328	+\$28	+\$133

General information





- Base unit includes ganging hardware to gang adjacent Storwal storage units together
- Electrical front cover with cutouts is located on opposite side as case fronts; these may be switched on site

Notes

In order to get a total cost on products when upcharges are present take the list price of the product number and add the upcharge cost shown to the list price.

For example:

Product SWB30-2FFE with Rectangular Glides would be \$1707 +\$28

Description	Part number	Height	Width	Weight (lbs)	Round glides/ base price	Rectangular glides	Accent paint upcharge
 2-12" files	SWB30-2FFE	33 1/8"	30"	120	\$1707	+\$28	+\$172
	SWB36-2FFE	33 1/8"	36"	142	\$1786	+\$28	+\$179
	SWB42-2FFE	33 1/8"	42"	154	\$1866	+\$28	+\$187
 2-6" box, 12" file	SWB30-2BFE	33 1/8"	30"	125	\$1707	+\$28	+\$172
	SWB36-2BFE	33 1/8"	36"	147	\$1786	+\$28	+\$179
	SWB42-2BFE	33 1/8"	42"	159	\$1866	+\$28	+\$187
 3" pencil, 2-12" files	SWB30-P2FFE	33 1/8"	30"	120	\$1707	+\$28	+\$172
	SWB36-P2FFE	33 1/8"	36"	142	\$1786	+\$28	+\$179
	SWB42-P2FFE	33 1/8"	42"	154	\$1866	+\$28	+\$187
 13.5" lift-up with fixed shelf, 10.5" file	SWB30-13LU10FE	33 1/8"	30"	120	\$1707	+\$28	+\$172
	SWB42-13LU10FE	33 1/8"	36"	142	\$1786	+\$28	+\$179
	SWB36-13LU10FE	33 1/8"	42"	154	\$1866	+\$28	+\$187

System

Storage

Storwal Storage

Base Modules 9900 Series Front

General information





- Base unit includes ganging hardware to gang adjacent Storwal storage units together
- Electrical front cover with cutouts is located on opposite side as case fronts; these may be switched on site

Notes

In order to get a total cost on products when upcharges are present take the list price of the product number and add the upcharge cost shown to the list price.

For example:

Product SWB30L-2FFHDE with Rectangular Glides would be \$2065 +\$28

Description	Part number	Height	Width	Weight (lbs)	Round glides/ base price	Rectangular glides	Accent paint upcharge
 <p>2-12" files on one side, hinged door on the other</p>	SWB30L-2FFHDE	33 1/8"	30"	130	\$2065	+\$28	+\$208
	SWB36L-2FFHDE	33 1/8"	36"	152	\$2220	+\$28	+\$223
	SWB42L-2FFHDE left-handed hinged door (illustrated)	33 1/8"	42"	164	\$2299	+\$28	+\$231
	SWB30R-2FFHDE	33 1/8"	30"	130	\$2065	+\$28	+\$208
	SWB36R-2FFHDE	33 1/8"	36"	152	\$2220	+\$28	+\$223
	SWB42R-2FFHDE right-handed hinged door	33 1/8"	42"	164	\$2299	+\$28	+\$231
 <p>2-6" box, 12" file on one side, hinged door on the other</p>	SWB30L-2BFHDE	33 1/8"	30"	130	\$2065	+\$28	+\$208
	SWB36L-2BFHDE	33 1/8"	36"	152	\$2220	+\$28	+\$223
	SWB42L-2BFHDE left-handed hinged door (illustrated)	33 1/8"	42"	164	\$2299	+\$28	+\$231
	SWB30R-2BFHDE	33 1/8"	30"	130	\$2065	+\$28	+\$208
	SWB36R-2BFHDE	33 1/8"	36"	152	\$2220	+\$28	+\$223
	SWB42R-2BFHDE right-handed hinged door	33 1/8"	42"	164	\$2299	+\$28	+\$231
 <p>2-6" box, 12" file on one side, 2-12" files on the other</p>	SWB30L-2BF2FE	33 1/8"	30"	130	\$2065	+\$28	+\$208
	SWB36L-2BF2FE	33 1/8"	36"	152	\$2220	+\$28	+\$223
	SWB42L-2BF2FE 2-12" files on left side (illustrated)	33 1/8"	42"	164	\$2299	+\$28	+\$231
	SWB30R-2BF2FE	33 1/8"	30"	130	\$2065	+\$28	+\$208
	SWB36R-2BF2FE	33 1/8"	36"	152	\$2220	+\$28	+\$223
	SWB42R-2BF2FE 2-12" files on right side	33 1/8"	42"	164	\$2299	+\$28	+\$231
 <p>3" pencil, 2-10.5" file on one side, hinged door on the other</p>	SWB30L-PFFHDE	33 1/8"	30"	130	\$2065	+\$28	+\$208
	SWB36L-PFFHDE	33 1/8"	36"	152	\$2220	+\$28	+\$223
	SWB42L-PFFHDE left-handed hinged door (illustrated)	33 1/8"	42"	164	\$2299	+\$28	+\$231
	SWB30R-PFFHDE	33 1/8"	30"	130	\$2065	+\$28	+\$208
	SWB36R-PFFHDE	33 1/8"	36"	152	\$2220	+\$28	+\$223
	SWB42R-PFFHDE right-handed hinged door	33 1/8"	42"	164	\$2299	+\$28	+\$231





General information

- Base unit includes ganging hardware to gang adjacent Storwal storage units together
- Electrical front cover with cutouts is located on opposite side as case fronts; these may be switched on site
- FP001 pull is standard for Nuform and veneer fronts
- Consult General Information for pull options
- Woodgrain and solid colors available

Notes

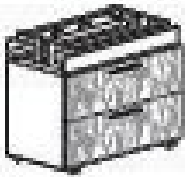
In order to get a total cost on products when upcharges are present take the list price of the product number and add the upcharge cost shown to the list price.

**For example:
Product SWB30-2FFQ with Rectangular Glides would be \$2288 +\$28**

Description	Part number	Height	Width	Weight (lbs)	Round glides/ base price	Rectangular glides	Accent paint upcharge
	2-12" files SWB30-2FFQ	33 1/8"	30"	120	\$2288	+\$28	+\$230
	SWB36-2FFQ	33 1/8"	36"	142	\$2288	+\$28	+\$221
	SWB42-2FFQ	33 1/8"	42"	154	\$2288	+\$28	+\$240
	2-6" box, 12" file SWB30-2BFQ	33 1/8"	30"	125	\$2288	+\$28	+\$230
	SWB36-2BFQ	33 1/8"	36"	147	\$2199	+\$28	+\$221
	SWB42-2BFQ	33 1/8"	42"	159	\$2391	+\$28	+\$240
	2-12" files on one side, hinged door on the other SWB30L-2FFHDQ	33 1/8"	30"	130	\$2607	+\$28	+\$261
	SWB36L-2FFHDQ	33 1/8"	36"	152	\$2875	+\$28	+\$289
	SWB42L-2FFHDQ left-handed hinged door	33 1/8"	42"	164	\$2997	+\$28	+\$301
	SWB30R-2FFHDQ	33 1/8"	30"	130	\$2607	+\$28	+\$261
	SWB36R-2FFHDQ	33 1/8"	36"	152	\$2875	+\$28	+\$289
	SWB42R-2FFHDQ right-handed hinged door (illustrated)	33 1/8"	42"	164	\$2997	+\$28	+\$301
	2-6" box, 12" file on one side, hinged door on the other SWB30L-2BFHDQ	33 1/8"	30"	130	\$2607	+\$28	+\$261
	SWB36L-2BFHDQ	33 1/8"	36"	152	\$2875	+\$28	+\$289
	SWB42L-2BFHDQ left-handed hinged door	33 1/8"	42"	164	\$2997	+\$28	+\$301
	SWB30R-2BFHDQ	33 1/8"	30"	130	\$2607	+\$28	+\$261
	SWB36R-2BFHDQ	33 1/8"	36"	152	\$2875	+\$28	+\$289
	SWB42R-2BFHDQ right-handed hinged door (illustrated)	33 1/8"	42"	164	\$2997	+\$28	+\$301
	2-6" box, 12" file on one side, 2-12" files on the other SWB30L-2BF2FQ	33 1/8"	30"	130	\$2607	+\$28	+\$261
	SWB36L-2BF2FQ	33 1/8"	36"	152	\$2875	+\$28	+\$289
	SWB42L-2BF2FQ 2-12" files on left side	33 1/8"	42"	164	\$2997	+\$28	+\$301
	SWB30R-2BF2FQ	33 1/8"	30"	130	\$2607	+\$28	+\$261
	SWB36R-2BF2FQ	33 1/8"	36"	152	\$2875	+\$28	+\$289
	SWB42R-2BF2FQ 2-12" files on right side (illustrated)	33 1/8"	42"	164	\$2997	+\$28	+\$301

System

Storage

Storwal Storage

Base Modules Composite Veneer Front

General information



- Base unit includes ganging hardware to gang adjacent Storwal storage units together
- Electrical front cover with cutouts is located on opposite side as case fronts; these may be switched on site
- FP001 pull is standard for Nuform and veneer fronts
- Consult General Information for pull options

Notes

In order to get a total cost on products when upcharges are present take the list price of the product number and add the upcharge cost shown to the list price.

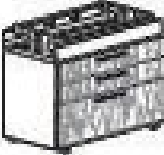

For example:

Product SWB30-2FFW with Rectangular Glides would be \$2692 +\$28

Description	Part number	Height	Width	Weight (lbs)	Round glides/ base price	Rectangular glides	Accent paint upcharge
 2-12" files	SWB30-2FFW	33 1/8"	30"	120	\$2692	+\$28	+\$270
	SWB36-2FFW	33 1/8"	36"	142	\$2919	+\$28	+\$293
	SWB42-2FFW	33 1/8"	42"	154	\$3055	+\$28	+\$306
 2-6" box, 12" file	SWB30-2BFW	33 1/8"	30"	120	\$2692	+\$28	+\$270
	SWB36-2BFW	33 1/8"	36"	142	\$2919	+\$28	+\$293
	SWB42-2BFW	33 1/8"	42"	154	\$3055	+\$28	+\$306
 2-12" files on one side, hinged door on the other	SWB30L-2FFHDW	33 1/8"	30"	130	\$3010	+\$28	+\$302
	SWB36L-2FFHDW	33 1/8"	36"	154	\$3740	+\$28	+\$375
	SWB42L-2FFHDW	33 1/8"	42"	164	\$3839	+\$28	+\$385
	left-handed hinged door						
	SWB30R-2FFHDW	33 1/8"	30"	130	\$3010	+\$28	+\$302
	SWB36R-2FFHDW	33 1/8"	36"	154	\$3740	+\$28	+\$375
SWB42R-2FFHDW	33 1/8"	42"	164	\$3839	+\$28	+\$385	
right-handed hinged door (illustrated)							
 2-6" box, 12" file on one side, hinged door on the other	SWB30L-2BFHDW	33 1/8"	30"	130	\$3010	+\$28	+\$302
	SWB36L-2BFHDW	33 1/8"	36"	154	\$3740	+\$28	+\$375
	SWB42L-2BFHDW	33 1/8"	42"	164	\$3839	+\$28	+\$385
	left-handed hinged door						
	SWB30R-2BFHDW	33 1/8"	30"	130	\$3010	+\$28	+\$302
	SWB36R-2BFHDW	33 1/8"	36"	154	\$3740	+\$28	+\$375
SWB42R-2BFHDW	33 1/8"	42"	164	\$3839	+\$28	+\$385	
right-handed hinged door (illustrated)							
 2-6" box, 12" file on one side, 2-12" files on the other	SWB30L-2BF2FW	33 1/8"	30"	130	\$3010	+\$28	+\$302
	SWB36L-2BF2FW	33 1/8"	36"	154	\$3740	+\$28	+\$375
	SWB42L-2BF2FW	33 1/8"	42"	164	\$3839	+\$28	+\$385
	2-12" files on left side						
	SWB30R-2BF2FW	33 1/8"	30"	130	\$3010	+\$28	+\$302
	SWB36R-2BF2FW	33 1/8"	36"	154	\$3740	+\$28	+\$375
SWB42R-2BF2FW	33 1/8"	42"	164	\$3839	+\$28	+\$385	
2-12" files on right side (illustrated)							

General information

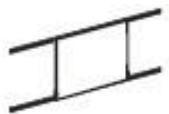
- Stack unit will achieve overall height of 51" h
- Install on Storwal Storage case where adjacent case is same width, allows for sliding door to cover either case
- Sliding doors are handed and should be ordered based on direction of slide to open door
- Sliding doors includes a 2" silver pull detail in upper quadrant of doors edge
- Consult General Information for pull options
- SuperStor insert available
- For 30" w insert add \$93 list
- For 36" w insert add \$109 list
- For 42" w insert add \$123 list
- SuperStore trays sold separately
- Sliding doors cannot be installed adjacent to back painted glass whiteboards or tackboards

Description	Part number	Height	Width	Weight (lbs)	List price	Accent paint upcharge
 Open Bookcase	SW3013.5BK	16 3/8"	30"	26	\$539	+\$55
	SW3613.5BK	16 3/8"	36"	32	\$569	+\$57
	SW4213.5BK	16 3/8"	42"	36	\$594	+\$60
 Nuform Solid Sliding Door	SWL3013.5SDS	16 3/8"	30"	8	\$489	—
	SWL3613.5SDS	16 3/8"	36"	10	\$513	—
	SWL4213.5SDS left-handed	16 3/8"	42"	12	\$534	—
	SWR3013.5SDS	16 3/8"	30"	8	\$489	—
	SWR3613.5SDS	16 3/8"	36"	10	\$513	—
	SWR4213.5SDS right-handed	16 3/8"	42"	12	\$534	—
 Nuform Woodgrain Sliding Door	SWL3013.5SDQ	16 3/8"	30"	8	\$489	—
	SWL3613.5SDQ	16 3/8"	36"	10	\$513	—
	SWL4213.5SDQ left-handed	16 3/8"	42"	12	\$534	—
	SWR3013.5SDQ	16 3/8"	30"	8	\$489	—
	SWR3613.5SDQ	16 3/8"	36"	10	\$513	—
	SWR4213.5SDQ right-handed	16 3/8"	42"	12	\$534	—
 Composite Veneer Sliding Door	SWL3013.5SDW	16 3/8"	30"	8	\$779	—
	SWL3613.5SDW	16 3/8"	36"	10	\$843	—
	SWL4213.5SDW left-handed	16 3/8"	42"	12	\$898	—
	SWR3013.5SDW	16 3/8"	30"	8	\$779	—
	SWR3613.5SDW	16 3/8"	36"	10	\$843	—
	SWR4213.5SDW right-handed	16 3/8"	42"	12	\$898	—

System





Storage

Storwal Storage

Stack Units 29 7/8" H

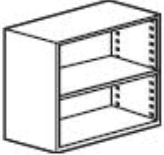
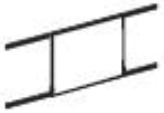
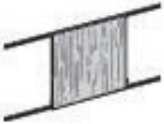
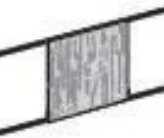

General information

- Stack unit will achieve overall height of 64" h
- Install on Storwal Storage case where adjacent case is same width, allows for sliding door to cover either case
- Sliding doors are handed and should be ordered based on direction of slide to open door
- Sliding doors includes a 2" silver pull detail in upper quadrant of doors edge.
- Consult General Information for pull options
- SuperStor insert available
- For 30" w insert add \$93 list
- For 36" w insert add \$109 list
- For 42" w insert add \$123 list
- SuperStore trays sold separately
- Sliding doors cannot be installed adjacent to back painted glass whiteboards or tackboards

Description	Part number	Height	Width	Weight (lbs)	List price	Accent paint upcharge		
	Open Bookcase	SW3027BK-SH	29 7/8"	30"	53	\$717	+\$73	
		SW3627BK-SH	29 7/8"	36"	65	\$732	+\$75	
		SW4227BK-SH	29 7/8"	42"	72	\$802	+\$81	
	Nuform Solid Slidig Door	SWL3027SDS	29 7/8"	30"	14	\$587	—	
		SWL3627SDS	29 7/8"	36"	17	\$632	—	
		SWL4227SDS left-handed	29 7/8"	42"	19	\$668	—	
			SWR3027SDS	29 7/8"	30"	14	\$587	—
			SWR3627SDS	29 7/8"	36"	17	\$632	—
			SWR4227SDS right-handed	29 7/8"	42"	19	\$668	—
	Nuform Woodgrain Slidig Door	SWL3027SDQ	29 7/8"	30"	14	\$587	—	
		SWL3627SDQ	29 7/8"	36"	17	\$632	—	
		SWL4227SDQ left-handed	29 7/8"	42"	19	\$668	—	
			SWR3027SDQ	29 7/8"	30"	14	\$587	—
			SWR3627SDQ	29 7/8"	36"	17	\$632	—
			SWR4227SDQ right-handed	29 7/8"	42"	19	\$668	—
	Composite Veneer Slidig Door	SWL3027SDW	29 7/8"	30"	14	\$1078	—	
		SWL3627SDW	29 7/8"	36"	17	\$1143	—	
		SWL4227SDW left-handed	29 7/8"	42"	19	\$1221	—	
			SWR3027SDW	29 7/8"	30"	14	\$1078	—
			SWR3627SDW	29 7/8"	36"	17	\$1143	—
			SWR4227SDW right-handed	29 7/8"	42"	19	\$1221	—
	1 Bookcase shelf with 1 magazine shelf	SW3027-SHMS	29 7/8"	30"	53	\$918	+\$93	
		SW3627-SHMS	29 7/8"	36"	65	\$966	+\$98	
		SW4227-SHMS	29 7/8"	42"	72	\$1014	+\$102	
	9900 Series Front Hinged Door with 1 Shelf	SW3027HDE-SH	29 7/8"	30"	83	\$1050	+\$106	
		SW3627HDE-SH	29 7/8"	36"	104	\$1072	+\$108	
		SW4227HDE-SH	29 7/8"	42"	120	\$1125	+\$113	
	Nuform Solid Front Hinged Door with 1 Shelf	SW3027HDS-SH	29 7/8"	30"	90	\$1120	+\$113	
		SW3627HDS-SH	29 7/8"	36"	112	\$1170	+\$118	
		SW4227HDS-SH	29 7/8"	42"	127	\$1263	+\$127	

General information

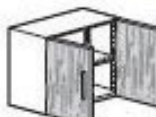
- Stack unit will achieve overall height of 64" h
 - Install on Storwal Storage case where adjacent case is same width, allows for sliding door to cover either case
 - Sliding doors are handed and should be ordered based on direction of slide to open door
 - Sliding doors includes a 2" silver pull detail in upper quadrant of doors edge
 - FP001 pull is standard for acrylic, Nuform and veneer fronts
 - Consult General Information for pull options
- SuperStor insert available
 - For 30" w insert add \$93 list
 - For 36" w insert add \$109 list
 - For 42" w insert add \$123 list
 - SuperStore trays sold separately
 - Sliding doors cannot be installed adjacent to back painted glass whiteboards or tackboards

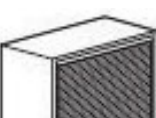
Description	Part number	Height	Width	Weight (lbs)	List price	Accent paint upcharge
 Nuform Woodgrain Front Hinged Door with 1 Shelf	SW3027HDQ-SH	29 7/8"	30"	90	\$1120	+\$113
	SW3627HDQ-SH	29 7/8"	36"	112	\$1170	+\$118
	SW4227HDQ-SH	29 7/8"	42"	127	\$1263	+\$127
 Composite Veneer Front Hinged Door with 1 Shelf	SW3027HDW-SH	29 7/8"	30"	90	\$1796	+\$180
	SW3627HDW-SH	29 7/8"	36"	112	\$1873	+\$188
	SW4227HDW-SH	29 7/8"	42"	127	\$2024	+\$203
 Glazed Front Hinged Door with 1 Shelf	SW3027HDJ-SH	29 7/8"	30"	88	\$2255	+\$227
	SW3627HDJ-SH	29 7/8"	36"	110	\$2470	+\$248
	SW4227HDJ-SH	29 7/8"	42"	125	\$2949	+\$296
 Tambour Door with 1 Shelf	SW3027TM-SH	29 7/8"	30"	88	\$1381	+\$139
	SW3627TM-SH	29 7/8"	36"	110	\$1446	+\$146
	SW4227TM-SH	29 7/8"	42"	125	\$1563	+\$157

System







Storage

Storwal Storage

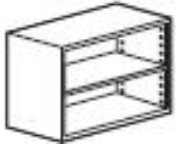
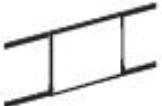
Stack Units 35 7/8" H

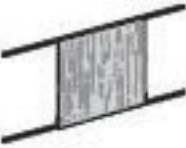

General information

- Stack unit will achieve overall height of 71" h
- Install on Storwal Storage case where adjacent case is same width, allows for sliding door to cover either case
- Sliding doors are handed and should be ordered based on direction of slide to open door
- Sliding doors includes a 2" silver pull detail in upper quadrant of doors edge
- Consult General Information for pull options
- SuperStor insert available
- For 30" w insert add \$93 list
- For 36" w insert add \$109 list
- For 42" w insert add \$123 list
- SuperStore trays sold separately
- Sliding doors cannot be installed adjacent to back painted glass whiteboards or tackboards

Description	Part number	Height	Width	Weight (lbs)	List price	Accent paint upcharge
	Open Bookcase					
	SW3033BK-SH	35 7/8"	30"	70	\$740	+\$75
	SW3633BK-SH	35 7/8"	36"	76	\$771	+\$78
	SW4233BK-SH	35 7/8"	42"	80	\$863	+\$87
	Nuform Solid Sliding Door					
	SWL3033SDS	35 7/8"	30"	17	\$632	—
	SWL3633SDS	35 7/8"	36"	19	\$682	—
	SWL4233SDS	35 7/8"	42"	23	\$730	—
	left-handed					
	SWR3033SDS	35 7/8"	30"	17	\$632	—
SWR3633SDS	35 7/8"	36"	19	\$682	—	
SWR4233SDS	35 7/8"	42"	23	\$730	—	
right-handed						
	Nuform Woodgrain Sliding Door					
	SWL3033SDQ	35 7/8"	30"	17	\$632	—
	SWL3633SDQ	35 7/8"	36"	19	\$682	—
	SWL4233SDQ	35 7/8"	42"	23	\$730	—
	left-handed					
	SWR3033SDQ	35 7/8"	30"	17	\$632	—
SWR3633SDQ	35 7/8"	36"	19	\$682	—	
SWR4233SDQ	35 7/8"	42"	23	\$730	—	
right-handed						
	Composite Veneer Sliding Door					
	SWL3033SDW	35 7/8"	30"	17	\$1147	—
	SWL3633SDW	35 7/8"	36"	19	\$1228	—
	SWL4233SDW	35 7/8"	42"	23	\$1328	—
	left-handed					
	SWR3033SDW	35 7/8"	30"	17	\$1147	—
SWR3633SDW	35 7/8"	36"	19	\$1228	—	
SWR4233SDW	35 7/8"	42"	23	\$1328	—	
right-handed						
	2 Bookcase shelf with 1 magazine shelf					
	SW3033-2SHMS	35 7/8"	30"	70	\$1022	+\$103
	SW3633-2SHMS	35 7/8"	36"	76	\$1072	+\$108
	SW4233-2SHMS	35 7/8"	42"	80	\$1126	+\$113
	9900 Series Front Hinged Door with 1 Shelf					
	SW3033HDE-SH	35 7/8"	30"	90	\$1072	+\$108
	SW3633HDE-SH	35 7/8"	36"	115	\$1108	+\$112
	SW4233HDE-SH	35 7/8"	42"	126	\$1167	+\$117
	Nuform Solid Front Hinged Door with 1 Shelf					
	SW3033HDS-SH	35 7/8"	30"	92	\$1176	+\$118
	SW3633HDS-SH	35 7/8"	36"	117	\$1247	+\$125
	SW4233HDS-SH	35 7/8"	42"	128	\$1368	+\$138

General information

- Stack unit will achieve overall height of 71" h
- Install on Storwal Storage case where adjacent case is same width, allows for sliding door to cover either case
- Sliding doors are handed and should be ordered based on direction of slide to open door
- Sliding doors includes a 2" silver pull detail in upper quadrant of doors edge
- FP001 pull is standard for acrylic, Nuform and veneer fronts
- Consult General Information for pull options
- SuperStor insert available
- For 30" w insert add \$93 list
- For 36" w insert add \$109 list
- For 42" w insert add \$123 list
- SuperStore trays sold separately
- Sliding doors cannot be installed adjacent to back painted glass whiteboards or tackboards

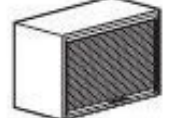
Description	Part number	Height	Width	Weight (lbs)	List price	Accent paint upcharge
 Nuform Woodgrain Front Hinged Door with 1 Shelf	SW3033HDQ-SH	35 7/8"	30"	92	\$1176	+\$118
	SW3633HDQ-SH	35 7/8"	36"	117	\$1247	+\$125
	SW4233HDQ-SH	35 7/8"	42"	128	\$1368	+\$138
 Composite Veneer Front Hinged Door with 1 Shelf	SW3033HDW-SH	35 7/8"	30"	92	\$1886	+\$189
	SW3633HDW-SH	35 7/8"	36"	117	\$1998	+\$200
	SW4233HDW-SH	35 7/8"	42"	128	\$2193	+\$220
 Glazed Front Hinged Door with 1 Shelf	SW3033HDJ-SH	35 7/8"	30"	90	\$2725	+\$274
	SW3633HDJ-SH	35 7/8"	36"	115	\$3044	+\$305
	SW4233HDJ-SH	35 7/8"	42"	126	\$3389	+\$340
 Tambour Door with 1 Shelf	SW3033TM-SH	35 7/8"	30"	90	\$1446	+\$146
	SW3633TM-SH	35 7/8"	36"	115	\$1536	+\$155
	SW4233TM-SH	35 7/8"	42"	126	\$1682	+\$169

System

Storage

Storage Storage

Wardrobe Towers 51" H

General information



- To be used with 51" H frames
- Ganging hardware is included with wardrobe cabinet
- Pass thru capability creates a horizontal septum where jumper cables may "pass thru" the case
- No electrical or data access in wardrobe units

Notes

In order to get a total cost on products when upcharges are present take the list price of the product number and add the upcharge cost shown to the list price.

For example:

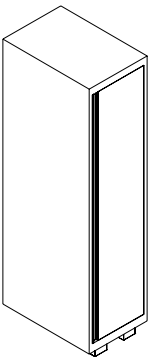
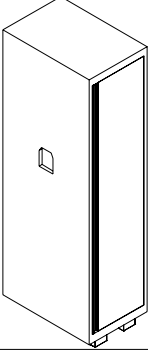
Product SWVL121845E with a Rectangular Glide would be \$1222 +\$28

Description	Part number	Height	Width	Depth	Round glides		
					Coat rod + shelf	Rectangular glides	Accent paint upcharge
 9900 Series Front Single Sided Wardrobe	SWVL121845E	49 3/8"	12"	18"	\$1222	+\$28	+\$123
	SWVL151845E	49 3/8"	15"	18"	\$1290	+\$28	+\$129
	SWVL181845E	49 3/8"	18"	18"	\$1360	+\$28	+\$137
	left-handed door						
	SWVR121845E	49 3/8"	12"	18"	\$1222	+\$28	+\$123
	SWVR151845E	49 3/8"	15"	18"	\$1290	+\$28	+\$129
 9900 Series Front Single Sided Wardrobe with pass-thru capability	SWVL121845EP	49 3/8"	12"	18"	\$1283	+\$28	+\$129
	SWVL151845EP	49 3/8"	15"	18"	\$1357	+\$28	+\$137
	SWVL181845EP	49 3/8"	18"	18"	\$1428	+\$28	+\$144
	left-handed door						
	SWVR121845EP	49 3/8"	12"	18"	\$1283	+\$28	+\$129
	SWVR151845EP	49 3/8"	15"	18"	\$1357	+\$28	+\$137
 9900 Series Front Double Sided Wardrobe	SWWLL121845E	49 3/8"	12"	18"	\$1448	+\$28	+\$146
	SWWLL151845E	49 3/8"	15"	18"	\$1517	+\$28	+\$153
	SWWLL181845E	49 3/8"	18"	18"	\$1585	+\$28	+\$160
	SWWLL2445E	49 3/8"	24"	18"	\$1896	+\$28	+\$190
	left-handed doors both sides						
	SWWRR121845E	49 3/8"	12"	18"	\$1448	+\$28	+\$146
	SWWRR151845E	49 3/8"	15"	18"	\$1517	+\$28	+\$153
	SWWRR181845E	49 3/8"	18"	18"	\$1585	+\$28	+\$160
	SWWRR2445E	49 3/8"	24"	18"	\$1896	+\$28	+\$190
	right-handed doors both sides (illustrated)						
	SWWRL121845E	49 3/8"	12"	18"	\$1448	+\$28	+\$146
	SWWRL151845E	49 3/8"	15"	18"	\$1517	+\$28	+\$153
SWWRL181845E	49 3/8"	18"	18"	\$1585	+\$28	+\$160	
SWWRL2445E	49 3/8"	24"	18"	\$1896	+\$28	+\$190	
left-handed door on one side, right-handed door on the other							

General information

- To be used with 51" H frames
- Ganging hardware is included with wardrobe cabinet
- Pass thru capability creates a horizontal septum where jumper cables may "pass thru" the case
- No electrical or data access in wardrobe units
- Woodgrain and solid colors available
- FP001 pull is standard for Nuform and veneer fronts
- Consult General Information for pull options

Notes

In order to get a total cost on products when upcharges are present take the list price of the product number and add the upcharge cost shown to the list price.

For example:
Product **SWWLL121845EP** with a Rectangular Glide would be **\$1521 +\$28**

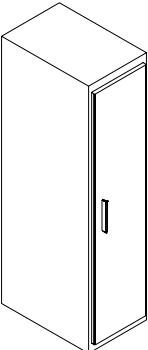
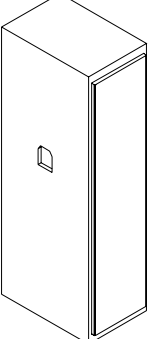
Description	Part number	Height	Width	Depth	Round glides	Coat rod + shelf	Rectangular glides	Accent paint upcharge	
 <p>9900 Series Front Double Sided Wardrobe with pass-thru capability</p>	SWWLL121845EP	49 3/8"	12"	18"		\$1521	+\$28	+\$153	
	SWWLL151845EP	49 3/8"	15"	18"		\$1592	+\$28	+\$160	
	SWWLL181845EP	49 3/8"	18"	18"		\$1665	+\$28	+\$167	
	SWWLL2445EP	49 3/8"	24"	18"		\$2080	+\$28	+\$209	
	left-handed doors both sides								
	SWWRR121845EP	49 3/8"	12"	18"		\$1521	+\$28	+\$153	
	SWWRR151845EP	49 3/8"	15"	18"		\$1592	+\$28	+\$160	
	SWWRR181845EP	49 3/8"	18"	18"		\$1665	+\$28	+\$167	
	SWWRR2445EP	49 3/8"	24"	18"		\$2080	+\$28	+\$209	
	right-handed doors both sides (illustrated)								
	SWWRL121845EP	49 3/8"	12"	18"		\$1521	+\$28	+\$153	
	SWWRL151845EP	49 3/8"	15"	18"		\$1592	+\$28	+\$160	
SWWRL181845EP	49 3/8"	18"	18"		\$1665	+\$28	+\$167		
SWWRL2445EP	49 3/8"	24"	18"		\$2080	+\$28	+\$209		
left-handed door on one side, right-handed door on the other									
 <p>Nuform Front Single Sided Wardrobe</p>	SWVL121845Q	49 3/8"	12"	18"		\$1467	+\$28	+\$148	
	SWVL151845Q	49 3/8"	15"	18"		\$1547	+\$28	+\$156	
	SWVL181845Q	49 3/8"	18"	18"		\$1631	+\$28	+\$164	
	left-handed door								
	SWVR121845Q	49 3/8"	12"	18"		\$1467	+\$28	+\$148	
	SWVR151845Q	49 3/8"	15"	18"		\$1547	+\$28	+\$156	
SWVR181845Q	49 3/8"	18"	18"		\$1631	+\$28	+\$164		
right-handed door (illustrated)									
 <p>Nuform Front Single Sided Wardrobe with pass-thru capability</p>	SWVL121845QP	49 3/8"	12"	18"		\$1540	+\$28	+\$155	
	SWVL151845QP	49 3/8"	15"	18"		\$1626	+\$28	+\$164	
	SWVL181845QP	49 3/8"	18"	18"		\$1712	+\$28	+\$172	
	left-handed door								
	SWVR121845QP	49 3/8"	12"	18"		\$1540	+\$28	+\$155	
	SWVR151845QP	49 3/8"	15"	18"		\$1626	+\$28	+\$164	
SWVR181845QP	49 3/8"	18"	18"		\$1712	+\$28	+\$172		
right-handed door (illustrated)									

System

Storage

Storage

Wardrobe Towers 51" H

General information



- To be used with 51" H frames
- Ganging hardware is included with wardrobe cabinet
- Pass thru capability creates a horizontal septum where jumper cables may "pass thru" the case
- No electrical or data access in wardrobe units
- Woodgrain and solid colors available
- FP001 pull is standard for Nuform and veneer fronts
- Consult General Information for pull options

Notes

In order to get a total cost on products when upcharges are present take the list price of the product number and add the upcharge cost shown to the list price.

For example:

Product SWWLL121845Q with a Rectangular Glide would be \$1738 +\$28

Description	Part number	Height	Width	Depth	Round glides			
					Coat rod + shelf	Rectangular glides	Accent paint upcharge	
 <p>Nuform Front Double Sided Wardrobe</p>	SWWLL121845Q	49 3/8"	12"	18"	\$1738	+\$28	+\$175	
	SWWLL151845Q	49 3/8"	15"	18"	\$1819	+\$28	+\$183	
	SWWLL181845Q	49 3/8"	18"	18"	\$1901	+\$28	+\$191	
	SWWLL2445Q	49 3/8"	24"	18"	\$2318	+\$28	+\$233	
	left-handed doors both sides							
	SWWRR121845Q	49 3/8"	12"	18"	\$1738	+\$28	+\$175	
	SWWRR151845Q	49 3/8"	15"	18"	\$1819	+\$28	+\$183	
	SWWRR181845Q	49 3/8"	18"	18"	\$1901	+\$28	+\$191	
	SWWRR2445Q	49 3/8"	24"	18"	\$2318	+\$28	+\$233	
	right-handed doors both sides (illustrated)							
	SWWRL121845Q	49 3/8"	12"	18"	\$1738	+\$28	+\$175	
	SWWRL151845Q	49 3/8"	15"	18"	\$1819	+\$28	+\$183	
	SWWRL181845Q	49 3/8"	18"	18"	\$1901	+\$28	+\$191	
	SWWRL2445Q	49 3/8"	24"	18"	\$2318	+\$28	+\$233	
	left-handed door on one side, right-handed door on the other							
	 <p>Nuform Front Double Sided Wardrobe with pass-thru capability</p>	SWWLL121845QP	49 3/8"	12"	18"	\$1825	+\$28	+\$183
SWWLL151845QP		49 3/8"	15"	18"	\$1911	+\$28	+\$192	
SWWLL181845QP		49 3/8"	18"	18"	\$1997	+\$28	+\$200	
SWWLL2445QP		49 3/8"	24"	18"	\$2501	+\$28	+\$251	
left-handed doors both sides								
SWWRR121845QP		49 3/8"	12"	18"	\$1825	+\$28	+\$183	
SWWRR151845QP		49 3/8"	15"	18"	\$1911	+\$28	+\$192	
SWWRR181845QP		49 3/8"	18"	18"	\$1997	+\$28	+\$200	
SWWRR2445QP		49 3/8"	24"	18"	\$2501	+\$28	+\$251	
right-handed doors both sides (illustrated)								
SWWRL121845QP		49 3/8"	12"	18"	\$1825	+\$28	+\$183	
SWWRL151845QP		49 3/8"	15"	18"	\$1911	+\$28	+\$192	
SWWRL181845QP		49 3/8"	18"	18"	\$1997	+\$28	+\$200	
SWWRL2445QP		49 3/8"	24"	18"	\$2501	+\$28	+\$251	
left-handed door on one side, right-handed door on the other								

General information

- To be used with 51" H frames
- Ganging hardware is included with wardrobe cabinet
- Pass thru capability creates a horizontal septum where jumper cables may "pass thru" the case
- No electrical or data access in wardrobe units
- FP001 pull is standard for Nuform and veneer fronts
- FP001 pull is standard for Nuform and veneer fronts
- Consult General Information for pull options

Notes

In order to get a total cost on products when upcharges are present take the list price of the product number and add the upcharge cost shown to the list price.

**For example:
Product SWWLL2445W with a Rectangular Glide would be \$2803 +\$28**

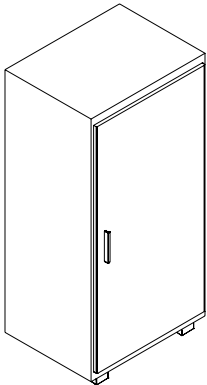
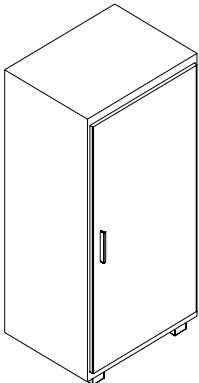
Description	Part number	Height	Width	Depth	Round glides	Accent paint upcharge
					Coat rod + shelf	
 <p>Composite Veneer Front Double Sided Wardrobe</p>	SWWLL2445W left-handed doors both sides	49 3/8"	24"	18"	\$2803	+\$282
	SWWRR2445W right-handed doors both sides (illustrated)	49 3/8"	24"	18"	\$2803	+\$282
	SWWRL2445W left-handed door on one side, right-handed door on the other	49 3/8"	24"	18"	\$2803	+\$282
 <p>Composite Veneer Front Double Sided Wardrobe with pass-thru capability</p>	SWWLL2445WP left-handed doors both sides	49 3/8"	24"	18"	\$2989	+\$300
	SWWRR2445WP right-handed doors both sides (illustrated)	49 3/8"	24"	18"	\$2989	+\$300
	SWWRL2445WP left-handed door on one side, right-handed door on the other	49 3/8"	24"	18"	\$2989	+\$300

System

Storage

Storage Storage

Wardrobe Towers 64" H

General information



- To be used with 64" H frames
- Ganging hardware is included with wardrobe cabinet
- Pass thru capability creates a horizontal septum where jumper cables may "pass thru" the case
- No electrical or data access in wardrobe units

Notes

In order to get a total cost on products when upcharges are present take the list price of the product number and add the upcharge cost shown to the list price.

For example:

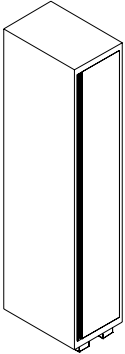
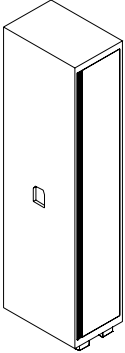
Product SWVL121858E with a Rectangular Glide would be \$1358 +\$28

Description	Part number	Height	Width	Depth	Round glides		
					Coat rod + shelf	Rectangular glides	Accent paint upcharge
 9900 Series Front Single Sided Wardrobe	SWVL121858E	62 7/8"	12"	18"	\$1358	+\$28	+\$137
	SWVL151858E	62 7/8"	15"	18"	\$1434	+\$28	+\$145
	SWVL181858E	62 7/8"	18"	18"	\$1475	+\$28	+\$149
	left-handed door						
	SWVR121858E	62 7/8"	12"	18"	\$1358	+\$28	+\$137
	SWVR151858E	62 7/8"	15"	18"	\$1434	+\$28	+\$145
	SWVR181858E	62 7/8"	18"	18"	\$1475	+\$28	+\$149
	right-handed door (illustrated)						
 9900 Series Front Single Sided Wardrobe with pass-thru capability	SWVL121858EP	62 7/8"	12"	18"	\$1426	+\$28	+\$144
	SWVL151858EP	62 7/8"	15"	18"	\$1507	+\$28	+\$152
	SWVL181858EP	62 7/8"	18"	18"	\$1547	+\$28	+\$156
	left-handed door						
	SWVR121858EP	62 7/8"	12"	18"	\$1426	+\$28	+\$144
	SWVR151858EP	62 7/8"	15"	18"	\$1507	+\$28	+\$152
	SWVR181858EP	62 7/8"	18"	18"	\$1547	+\$28	+\$156
	right-handed door (illustrated)						
 9900 Series Front Double Sided Wardrobe	SWWLL121858E	62 7/8"	12"	18"	\$1584	+\$28	+\$159
	SWWLL151858E	62 7/8"	15"	18"	\$1660	+\$28	+\$167
	SWWLL181858E	62 7/8"	18"	18"	\$1701	+\$28	+\$171
	SWWLL2458.5E	62 7/8"	24"	18"	\$2057	+\$28	+\$207
	left-handed doors both sides						
	SWWRR121858E	62 7/8"	12"	18"	\$1584	+\$28	+\$159
	SWWRR151858E	62 7/8"	15"	18"	\$1660	+\$28	+\$167
	SWWRR181858E	62 7/8"	18"	18"	\$1701	+\$28	+\$171
	SWWRR2458.5E	62 7/8"	24"	18"	\$2057	+\$28	+\$207
	right-handed doors both sides (illustrated)						
	SWWRL121858E	62 7/8"	12"	18"	\$1584	+\$28	+\$159
	SWWRL151858E	62 7/8"	15"	18"	\$1660	+\$28	+\$167
	SWWRL181858E	62 7/8"	18"	18"	\$1701	+\$28	+\$171
	SWWRL2458.5E	62 7/8"	24"	18"	\$2057	+\$28	+\$207
	left-handed door on one side, right-handed door on the other						

General information

- To be used with 64" H frames
- Ganging hardware is included with wardrobe cabinet
- Pass thru capability creates a horizontal septum where jumper cables may "pass thru" the case
- No electrical or data access in wardrobe units

Notes

In order to get a total cost on products when upcharges are present take the list price of the product number and add the upcharge cost shown to the list price.

For example:

Product **SWWLL121858E** with a **Rectangular Glide** would be **\$1584 +\$28**

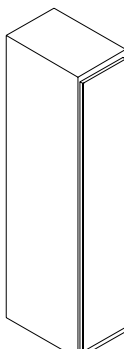
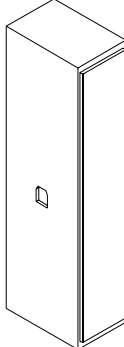
Description	Part number	Height	Width	Depth	Round glides	Rectangular glides	Accent paint upcharge	
					Coat rod + shelf			
 <p>9900 Series Front Double Sided Wardrobe with pass-thru capability</p>	SWWLL121858EP	62 7/8"	12"	18"	\$1663	+\$28	+\$167	
	SWWLL151858EP	62 7/8"	15"	18"	\$1742	+\$28	+\$175	
	SWWLL181858EP	62 7/8"	18"	18"	\$1786	+\$28	+\$179	
	SWWLL2458.5EP	62 7/8"	24"	18"	\$2241	+\$28	+\$225	
	left-handed doors both sides							
	SWWRR121858EP	62 7/8"	12"	18"	\$1663	+\$28	+\$167	
	SWWRR151858EP	62 7/8"	15"	18"	\$1742	+\$28	+\$175	
	SWWRR181858EP	62 7/8"	18"	18"	\$1786	+\$28	+\$179	
	SWWRR2458.5EP	62 7/8"	24"	18"	\$2241	+\$28	+\$225	
	right-handed doors both sides (illustrated)							
	SWWRL121858EP	62 7/8"	12"	18"	\$1663	+\$28	+\$167	
	SWWRL151858EP	62 7/8"	15"	18"	\$1742	+\$28	+\$175	
SWWRL181858EP	62 7/8"	18"	18"	\$1786	+\$28	+\$179		
SWWRL2458.5EP	62 7/8"	24"	18"	\$2241	+\$28	+\$225		
left-handed door on one side, right-handed door on the other								
 <p>Nuform Front Single Sided Wardrobe</p>	SWVL121858Q	62 7/8"	12"	18"	\$1629	+\$28	+\$164	
	SWVL151858Q	62 7/8"	15"	18"	\$1680	+\$28	+\$169	
	SWVL181858Q	62 7/8"	18"	18"	\$1771	+\$28	+\$178	
	left-handed door							
	SWVR121858Q	62 7/8"	12"	18"	\$1629	+\$28	+\$164	
	SWVR151858Q	62 7/8"	15"	18"	\$1680	+\$28	+\$169	
SWVR181858Q	62 7/8"	18"	18"	\$1771	+\$28	+\$178		
right-handed door (illustrated)								
 <p>Nuform Front Single Sided Wardrobe with pass-thru capability</p>	SWVL121858QP	62 7/8"	12"	18"	\$1709	+\$28	+\$172	
	SWVL151858QP	62 7/8"	15"	18"	\$1806	+\$28	+\$181	
	SWVL181858QP	62 7/8"	18"	18"	\$1858	+\$28	+\$186	
	left-handed door							
	SWVR121858QP	62 7/8"	12"	18"	\$1709	+\$28	+\$172	
	SWVR151858QP	62 7/8"	15"	18"	\$1806	+\$28	+\$181	
SWVR181858QP	62 7/8"	18"	18"	\$1858	+\$28	+\$186		
right-handed door (illustrated)								

System

Storage

Storage Storage

Wardrobe Towers 64" H

General information



- To be used with 64" H frames
- Ganging hardware is included with wardrobe cabinet
- Pass thru capability creates a horizontal septum where jumper cables may "pass thru" the case
- No electrical or data access in wardrobe units
- Woodgrain and solid colors available
- FP001 pull is standard for Nuform and veneer fronts
- Consult General Information for pull options

Notes

In order to get a total cost on products when upcharges are present take the list price of the product number and add the upcharge cost shown to the list price.

For example:

Product SWWLL121845EP with a Rectangular Glide would be \$1468 +\$26

Description	Part number	Height	Width	Depth	Coat rod + shelf	Round glides	Accent paint upcharge	
						Rectangular glides		
 <p>Nuform Front Double Sided Wardrobe</p>	SWWLL121858Q	62 7/8"	12"	18"	\$1900	+\$28	+\$191	
	SWWLL151858Q	62 7/8"	15"	18"	\$1993	+\$28	+\$200	
	SWWLL181858Q	62 7/8"	18"	18"	\$2042	+\$28	+\$206	
	SWWLL2458.5Q	62 7/8"	24"	18"	\$2591	+\$28	+\$260	
	left-handed doors both sides							
	SWWRR121858Q	62 7/8"	12"	18"	\$1900	+\$28	+\$191	
	SWWRR151858Q	62 7/8"	15"	18"	\$1993	+\$28	+\$200	
	SWWRR181858Q	62 7/8"	18"	18"	\$2042	+\$28	+\$206	
	SWWRR2458.5Q	62 7/8"	24"	18"	\$2591	+\$28	+\$260	
	right-handed doors both sides (illustrated)							
	SWWRL121858Q	62 7/8"	12"	18"	\$1900	+\$28	+\$191	
	SWWRL151858Q	62 7/8"	15"	18"	\$1993	+\$28	+\$200	
	SWWRL181858Q	62 7/8"	18"	18"	\$2042	+\$28	+\$206	
	SWWRL2458.5Q	62 7/8"	24"	18"	\$2591	+\$28	+\$260	
	left-handed door on one side, right-handed door on the other							
	 <p>Nuform Front Double Sided Wardrobe with pass-thru capability</p>	SWWLL121858QP	62 7/8"	12"	18"	\$1996	+\$28	+\$200
SWWLL151858QP		62 7/8"	15"	18"	\$2091	+\$28	+\$210	
SWWLL181858QP		62 7/8"	18"	18"	\$2144	+\$28	+\$216	
SWWLL2458.5QP		62 7/8"	24"	18"	\$2776	+\$28	+\$279	
left-handed doors both sides								
SWWRR121858QP		62 7/8"	12"	18"	\$1996	+\$28	+\$200	
SWWRR151858QP		62 7/8"	15"	18"	\$2091	+\$28	+\$210	
SWWRR181858QP		62 7/8"	18"	18"	\$2144	+\$28	+\$216	
SWWRR2458.5QP		62 7/8"	24"	18"	\$2776	+\$28	+\$279	
right-handed doors both sides (illustrated)								
SWWRL121858QP		62 7/8"	12"	18"	\$1996	+\$28	+\$200	
SWWRL151858QP		62 7/8"	15"	18"	\$2091	+\$28	+\$210	
SWWRL181858QP		62 7/8"	18"	18"	\$2144	+\$28	+\$216	
SWWRL2458.5QP		62 7/8"	24"	18"	\$2776	+\$28	+\$279	
left-handed door on one side, right-handed door on the other								

General information



- To be used with 64" H frames
- Ganging hardware is included with wardrobe cabinet
- Pass thru capability creates a horizontal septum where jumper cables may "pass thru" the case
- No electrical or data access in wardrobe units
- Nuform woodgrain and solid colors available
- FP001 pull is standard for Nuform and veneer fronts
- Consult General Information for pull options

Notes

In order to get a total cost on products when upcharges are present take the list price of the product number and add the upcharge cost shown to the list price.

For example:

Product SWWLL121858Q with a Rectangular Glide would be \$1900 +\$28

Description	Part number	Height	Width	Depth	Round glides	Coat rod + shelf	Rectangular glides	Accent paint upcharge
 <p>Composite Veneer Front Double Sided Wardrobe</p>	SWWLL2458.5W left-handed doors both sides	62 7/8"	12"	18"		\$3068	+\$28	+\$308
	SWWRR2458.5W right-handed doors both sides (illustrated)	62 7/8"	15"	18"		\$3068	+\$28	+\$308
	SWWRL2458.5W left-handed door on one side, right-handed door on the other	62 7/8"	18"	18"		\$3068	+\$28	+\$308
 <p>Composite Veneer Front Double Sided Wardrobe with pass-thru capability</p>	SWWLL2458.5WP left-handed doors both sides	62 7/8"	12"	18"		\$3252	+\$28	+\$326
	SWWRR2458.5WP right-handed doors both sides (illustrated)	62 7/8"	15"	18"		\$3252	+\$28	+\$326
	SWWRL2458.5WP left-handed door on one side, right-handed door on the other	62 7/8"	18"	18"		\$3252	+\$28	+\$326

System

Storage

Storage

Wardrobe Towers 71" H

General information



- To be used with 71" H frames
- Ganging hardware is included with wardrobe cabinet
- Pass thru capability creates a horizontal septum where jumper cables may "pass thru" the case
- No electrical or data access in wardrobe units
- FP001 pull is standard for Nuform and veneer fronts
- Consult General Information for pull options

Notes

In order to get a total cost on products when upcharges are present take the list price of the product number and add the upcharge cost shown to the list price.

For example:

Product SWWLL2458.5WP with a Rectangular Glide would be \$3252 +\$28

Description	Part number	Height	Width	Depth	Round glides		
					Coat rod + shelf	Rectangular glides	Accent paint upcharge
 <p>9900 Series Front Double Sided Wardrobe</p>	SWWLL2464.5E left-handed doors both sides	68 7/8"	24"	18"	\$2121	+\$28	+\$213
	SWWRR2464.5E right-handed doors both sides (illustrated)	68 7/8"	24"	18"	\$2121	+\$28	+\$213
	SWWRL2464.5E left-handed door on one side, right-handed door on the other	68 7/8"	24"	18"	\$2121	+\$28	+\$213
 <p>9900 Series Front Double Sided Wardrobe with pass-thru capability</p>	SWWLL2464.5EP left-handed doors both sides	68 7/8"	24"	18"	\$2307	+\$28	+\$232
	SWWRR2464.5EP right-handed doors both sides (illustrated)	68 7/8"	24"	18"	\$2307	+\$28	+\$232
	SWWRL2464.5EP left-handed door on one side, right-handed door on the other	68 7/8"	24"	18"	\$2307	+\$28	+\$232



General information

- To be used with 71" H frames
- Ganging hardware is included with wardrobe cabinet
- Pass thru capability creates a horizontal septum where jumper cables may "pass thru" the case
- No electrical or data access in wardrobe units

Notes

In order to get a total cost on products when upcharges are present take the list price of the product number and add the upcharge cost shown to the list price.

For example:
Product **SWWLL2464.5E** with a Rectangular Glide would be **\$2121 +\$28**

Description	Part number	Height	Width	Depth	Round glides	Coat rod + shelf	Rectangular glides	Accent paint upcharge
 <p>Nuform Front Double Sided Wardrobe</p>	SWWLL2464.5Q left-handed doors both sides	68 7/8"	24"	18"		\$2653	+\$28	+\$266
	SWWRR2464.5Q right-handed doors both sides (illustrated)	68 7/8"	24"	18"		\$2653	+\$28	+\$266
	SWWRL2464.5Q left-handed door on one side, right-handed door on the other	68 7/8"	24"	18"		\$2653	+\$28	+\$266
 <p>Nuform Front Double Sided Wardrobe with pass-thru capability</p>	SWWLL2464.5QP left-handed doors both sides	68 7/8"	24"	18"		\$2836	+\$28	+\$285
	SWWRR2464.5QP right-handed doors both sides (illustrated)	68 7/8"	24"	18"		\$2836	+\$28	+\$285
	SWWRL2464.5QP left-handed door on one side, right-handed door on the other	68 7/8"	24"	18"		\$2836	+\$28	+\$285

System

Storage

Storwal Storage

Wardrobe Towers 71" H

General information



- To be used with 71" H frames
- Ganging hardware is included with wardrobe cabinet
- Pass thru capability creates a horizontal septum where jumper cables may "pass thru" the case
- No electrical or data access in wardrobe units
- Woodgrain and solid colors available
- FP001 pull is standard for Nuform and veneer fronts
- Consult General Information for pull options

Notes

In order to get a total cost on products when upcharges are present take the list price of the product number and add the upcharge cost shown to the list price.

For example:

Product SWWLL2464.5Q with a Rectangular Glide would be \$2653 +\$28

Description	Part number	Height	Width	Depth	Round glides		
					Coat rod + shelf	Rectangular glides	Accent paint upcharge
 <p>Composite Veneer Front Double Sided Wardrobe</p>	SWWLL2464.5W left-handed doors both sides	68 7/8"	24"	18"	\$3254	+\$28	+\$326
	SWWRR2464.5W right-handed doors both sides (illustrated)	68 7/8"	24"	18"	\$3254	+\$28	+\$326
	SWWRL2464.5W left-handed door on one side, right-handed door on the other	68 7/8"	24"	18"	\$3254	+\$28	+\$326
 <p>Composite Veneer Front Double Sided Wardrobe with pass-thru capability</p>	SWWLL2464.5WP left-handed doors both sides	68 7/8"	24"	18"	\$3439	+\$28	+\$345
	SWWRR2464.5WP right-handed doors both sides (illustrated)	68 7/8"	24"	18"	\$3439	+\$28	+\$345
	SWWRL2464.5WP left-handed door on one side, right-handed door on the other	68 7/8"	24"	18"	\$3439	+\$28	+\$345

system

Accessories

General information

Inscape System accessories include panel and table-mounted organizers, bin/shelf-mounted slanted sorters, whiteboards, wall-mounted tack boards, panel mounted accessory shelves, pencil drawer, signage, a picture hook, coat hook and table-mounted accessory shelves. The panel and table-mounted organizers are easy to install, move and reconfigure and provide a comprehensive solution for effectively managing paper and other office supplies.

Horizontal organizers

A variety of work tool Horizontal Organizers may be positioned at any point along the width of the paper management tiles. The three slat design allows for three different height options - customizing and providing adjustability to suit individual needs and preferences. Re-positioning the height of the trays can be easily done by lifting the trays out of the slats on the tile. Horizontal paper management accessories are available in colors shown in the Color Guide. These paper management organizers can withstand max 5lbs. The storage compartments are clear plastic. **The Personal Box** is 32" wide and may be mounted on a paper management tile. The maximum weight capacity of the personal box is 22lbs. The sliding door may be painted in colors shown in the Color Guide. The "box" portion is constructed of an MDF substrate wrapped in white laminate.

Coat hooks, picture hooks and signage

Coat Hooks, Picture Hooks and Signage are manufactured from steel and snap onto panel crossrails without tools. Signage is available 9" wide. The sign insert channel is 1" high. Insert is customer generated and can be printed on any printer compatible paper. Printing instructions are included. A strip of clear plastic slides into the channel to protect the printed identification card.

Pencil drawers

Pencil Drawers can be installed under any Inscape System worksurface and are available in two different widths, increasing the amount of usable storage within the workstation.

Panel-mounted accessory shelves

Panel-Mounted Accessory Shelves mount onto Inscape System panels and hold small items such as picture frames and clocks. Manufactured from extruded aluminum, accessory shelves are available in seven widths and protrude only 5 1/8" from the panel once installed.

Table mounted accessory shelves

Table Mounted Accessory Shelves are 8" deep and available in a variety of widths. Shelves are shipped with mounting hardware to clamp onto the 1" or 1.25" thick surface.

Touch up paint

Touch Up Paint is available in 1/2 pint cans to repair minor scratches on trim, tiles and cabinets. Paint may also be specified in aerosol cans for any of our standard paint colors with the exception of mica and textured paint finishes. Custom enamel finishes are available in liquid only.

NOTE: Restrictions may apply to shipping aerosol cans; contact your Client Services Representative.

CPU holder

The CPU Holder mounts to the underside of any 1" or 1.25" thick worksurface. The AU200CU is non-locking and has a track size of 17". This CPU holder has a weight capacity of 13lbs. This CPU holder has a plastic glide track style. The AU300CU is non-locking with a weight capacity of 17lbs and has a track size of 17" with a ball bearing style track. All CPU holders have a height range of 14.5"/22.5" and a width range of 3.5"/9.3".

Tile reveal strips

Tile Reveal Strips install onto the edge of 13.5" high tiles to conceal cabling passing between tiles. Two tile reveal strips per tile abutment are required to conceal opening. (Reveal strips are included with 6.75" high tiles).

NOTE: Reveal strips for steel/upholstered tiles are not interchangeable with reveal strips for Woodgrain tiles. To be used when a brick pattern tile configuration is specified.

Worksurface stretcher bar

Worksurface stretcher bar is additional structural support for unsupported worksurfaces of 54" or greater. It is 1 1/2" high and the length of the stretcher bar is chosen based on the width of the worksurface. Be sure that there are no legs or panel mounted worksurface support brackets that may interfere with the stretcher bar.

Panel-mounted whiteboards

Panel-Mounted Whiteboards are available in two tile heights and in five tile widths. They are manufactured from steel and are powder-coated with white paint specially formulated for dry erase markers.

NOTE: Only Expo Markers are to be used on any Inscape Whiteboard. Whiteboards should be cleaned with Expo Eraser or a Microfiber cleaning cloth along with Expo Cleaning Solution which is formulated to remove residue from Expo Dry Erase Markers.

Crossrails

Crossrails are available for order when a tile configuration requires a different mount of the tile from where crossrails are placed when shipped. These crossrails are based on the width of the panel as well as the thickness, either 2.75" or 3.5". Crossrails are shipped with mounting hardware as well as tile clips.

Modesty Panels

Modesty Panels are available in a variety of options including painted, Nuform, laminate, veneer, acrylic and frame frosted acrylic. Panels are available in Partial Height of 13.5" and Full Height of 24" versions and a number of widths. Calculations must be made to determine the correct width dimension of Modesty Panel should be specified to accommodate the desired space. All mounting hardware is included in the product code and are installed on-site.

Table mounted fabric screen

The Table Mounted Fabric Screen is constructed of a 1.5" thick extruded aluminum frame and is designed to provide modesty and privacy to adjacent work areas. This 37" high screen mounts onto a 1" or 1.25" thick worksurface and may be adjusted vertically to create the desired privacy or modesty. The tackable 0.5" thick core may be specified in any of Inscape's standard fabrics or COM. Height adjustable brackets allow for various screen height positions. It is recommended that the table mounted screen be installed 20" above the surface with 16" below. Table mounted screens cannot be attached at 90° connections to 3.5" thick frames.

Table mounted acrylic screens

Table Mounted Acrylic Screens ship with standoff hardware to mount to a 1" or a 1.25" thick worksurface. The acrylic is a white finish with pre-drilled holes. When mounted, the screen extends 15.5" above the worksurface. Mounting hardware is included within the kit.

Freestanding table screens

The Freestanding Side Screen acts as a portable or stationary screen that separates two spaces adjacent to one another. The screen is made of 6mm thick frosted acrylic which is 13" high, seated in a painted aluminum extrusion, which can be painted any of Inscape's standard colors. The width of the screens is such that they are 5" less than the depth of our standard worksurfaces.

Add-on glazing

Add-on Glazing is manufactured from ¼" tempered glass. A ⅜" tempered glass is also available. Glazing may be mounted to the top of any equivalent Inscape System frame or combination of frames outlined in the Application Guide. Glazing is available in clear, gray, etched one or two sides and designer glass Strie options. Add-on Glazing includes top trim, glass mounting extrusion and specified glass. Add-on Glazing is specified based on the thickness of the panel.

NOTE: Hi-lo Add-on Glazing must be specified when installed directly adjacent to a higher panel at an inline situation only. The glaze and extrusion are inset on one side to allow for hi-lo vertical trim on the adjacent higher panel. If the situation calls for hi-lo on both sides, a special may be required. An Add on Glazing alignment clip is included with each Add on Glaze ordered.

Wall Mounted Accessories

Wall Mounted Accessories include tackboards, whiteboards and paper management rails. These accessories ship with mounting hardware and instructions on how to install them onto the wall. Re-enforcing of the wall should be taken into account when wall mounting any accessory for additional weight. Tackboards may be specified with any of our standard fabrics or a COM all are applied railroad orientation. The paper management rail may be specified with any of the colors found in the Color Guide.

Bin/Shelf-Mounted sorters install beneath overhead bins and shelves and hold literature, correspondence, notes, etc. Sorters are available in right and left-handed models and are easily repositioned by sliding horizontally along the length of the bin or shelf. Sorters ship in packages of three and may be painted in any of Inscape's color options. Bin and shelf sorters are specific to the unit they are being mounted on. Sorters are suitable for paper literature. Sliding Dividers may be placed in the overhead bin within a channel and slid to divide binders and other literature.

Magnetic whiteboards

Magnetic Whiteboards are available to mount on the side access tower. Available in 13.25" width only and two heights, the magnetic whiteboard is manufactured from steel and powder-coated with white paint formulated for use with dry-erase markers. Magnetic whiteboards include a 10.5" wide marker tray.

Only Expo Markers are to be used on any Inscape Whiteboard. Whiteboards should be cleaned with Expo Eraser or a Microfiber cleaning cloth along with Expo Cleaning Solution which is formulated to remove residue from Expo Dry Erase Markers.

Hangfile bars

Hangfile Bars are shipped as a pair and are used for 10.5", 12", 13.5", 15" and 16.5" pullout shelves/drawers.

Inviromass counterweights

Inviromass Counterweights for field installation "IMCW-30, IMCW-36 and IMCW-42" consist of one Inviromass plate and one retaining wire. These plates are to be field installed into lateral file cabinet by inserting the 30", 36" or 42" wide retaining wire into holes in the left and right hand rear stripe's.

The "INCW" for field installation consists of two 24lbs steel plates. These are affixed to back interior of case using peel and stripe two way tape.

System care kits

System Care Kits are panel thickness specific. Included in this care kit is the following: panel hook and latch assembly, 2-way 90° connectors, tile clips, end of line plugs, Dekko electrical clips, inline connector and trim clips.

Back painted glass

Back Painted Glass is a 6mm tempered glass addition to the back of Planna Storage cases. This glass is installed on the back of the case with stand off assemblies and holes that are field drilled into the case. Glass is painted on one side and available in white. Mounting hardware included.

SuperStor inserts

SuperStor Inserts can be specified as an 'option' in the upper stack unit of the Storwal Storage system. It may also be purchased separately and field installed using #10 self-drilling 'Tek' screws. The pre slotted back panel of the insert accepts SuperStor Trays which are available in any of Inscape's standard paint colors plus textured finishes. Trays must be specified separately and for ease of specification are sold in packages: standard trays - package of 6, small trays - package of 3. The 30" insert is slotted to accept 12 Standard Trays (2 pkgs) and 3 Small Trays (1 pkg), the 36" insert is slotted to accept 18 Standard Trays (3 pkgs) and the 42" insert is slotted to accept 18 Standard Trays (3 pkgs) and 3 Small Trays (1 pkg).

Planna support bracket

Planna support bracket is specified to be mounted on Planna rail and floats the worksurface off the bracket. Bracket is available in all standard paint colors. Bracket "snaps" into the rail without the need for tools. These are shipped as a pair and both must be installed per worksurface.

Hat Channel

Hat channels are used to support a worksurface off of a 21"ID Planna storage case and are available in any of Inscape's standard paint finishes. They are nominal in height and support a worksurface at a standard 28.5" height.

Lateral and pedestal rail kits

Lateral and Pedestal Rail Kits are available for separate purchase to create alternative applications when mounted on standard Office Specialty cases. These kits must be field installed. Rail Kits consist of a pair of extruded aluminum rails painted in 'Aluminum Leaf' and a pair of mounting rails that act as a 'reveal' and secure the Planna Storage rails into a box substructure to support the Planna Storage 0.5" thick lateral top.

End anchor units must be 36" wide. Specify CREDENZA STORAGE-KIT36 separately. Center units will be positioned back-to-back and may be 30", 36" or 42" wide.

If Center Units = 30" wide, specify 2 x CREDENZA STORAGEKIT3615
 If Center Units = 36" wide, specify 2 x CREDENZA STORAGEKIT36
 If Center Units = 42" wide, specify 2 x CREDENZA STORAGEKIT3621

Using pre-configured or buildup cases with 36" I.D. (interior dimension) will provide finished height to top of worksurface of 43". Use adjustment in Planna Storage brackets to lower worksurface height to suit seating height.

Lateral tops

The Lateral Tops are available in 1/2" and 3/8" thick options. The 1/2" thick option has been designed for Planna Storage applications in freestanding, benching or private office applications (may be specified on any lateral case). When being specified with the top fully spanning the Planna Storage benching frame or partially, there are a number of tops to accommodate the clean visual of having a continuous top over the panel. Depths are 1.75" or 3.5" deeper than standard tops to accommodate the various Planna Storage benching applications. The 21.5" deep Planna Storage lateral tops work in conjunction with the two Planna Storage units which access electrical through the back of the case. The 3.5" gap created behind the case provides space for cables to be plugged in and routed into the case. The same concept may be applied when specifying lateral tops for Private Office applications and requiring an additional 3.5" deep top. The 3/8" top is ideal for Storwal Storage applications and freestanding laterals. These are NOT to be specified on Planna Storage cases.

Cushion program

The Cushion Program consists of a slim line 1.25" thick 5-piece cushion featuring double row top stitching for a crisp, rectilinear styling. Interior is Cal. 117 fire-retardant polyurethane foam with a 2.2lb/ft. density. This upholstered cushion is balanced with a 3/16" board and is attached to the cabinet top with Velcro. Select from our graded upholstery program of solid color fabrics and vinyl's or choose COM option (Customers Own Material). To determine if a COM fabric has been pre-approved for use on our cushion topper, contact your Client Services Representative or go to www.inscapesolutions.com.

For application of all fabrics, both from our graded program as well as COM (Customers Own Material) please specify lay-up orientation at time of order. If lay-up instructions are not provided we will choose the direction to maximize our production. Refer to diagram for lay-up instructions. Please contact your Client Services Representative to confirm yardage requirements for your order. All COM fabric must be pre-approved. Your CSR can determine if your COM has already been pretested for application. A fully graded program has been set up for cushions. Various sizes of cushion have been designed for applications ranging from freestanding, benching and private office applications.

Cushion application notes

When ordering a Planna Storage cushion to lie flush next to a Planna Storage case with rail/lateral surface, select your Planna Storage case with 'no rails' option.

Pedestal fabric lay up instructions

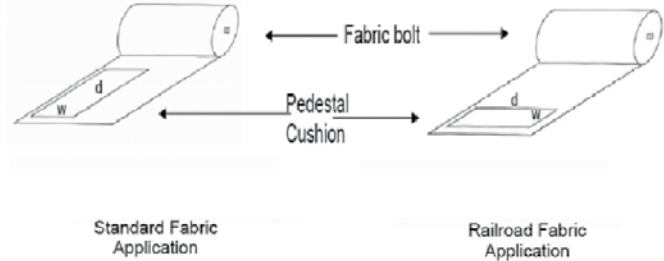

Lateral fabric lay up instructions

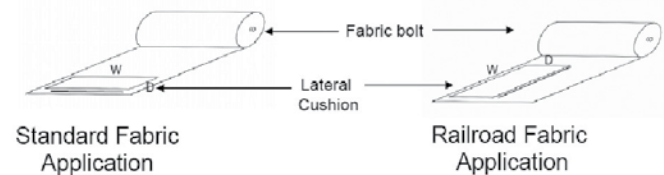

Due to the nature of the design and manufacture of our cushion, only approved fabrics will be accepted for application. For a description of the procedure required for COM fabric approval see sample 'Cushion COM Test Request' form found in the General Information section of this price list. This form can be downloaded from the Administration section of Insite or by contacting your Client Services Representative for assistance.

Storwal storage support brackets

Storwal Storage Support Brackets support one side of a worksurface off the Storwal Storage case. The other side must be supported by using a combination of post legs, cantilevers and/or MSSB brackets. Support brackets are used to support worksurfaces from storage cases. A fixed height and an adjustable height bracket allow for the option of adjustment or not. Be sure to specify correct support with adjustment at all points along the worksurface if height adjustment is a priority. Adjustment is available in five heights to support various working styles.

Storwal storage tackboards

Storwal Storage Tackboards mount to the back of an Storwal Storage stacked case and should be specified based on this width and height. Tack boards are available in any of Inscape's standard fabric offerings in addition to COM. White or extremely light colored COM fabric will incur an up charge of 25% to the tackboard pricing due to special handling of the fabric. Fabric is applied in a railroad orientation.

Storwal storage whiteboards

Storwal Storage Whiteboards are specified based on whether they are or are not being installed adjacent to sliding doors. If one is being specified adjacent to a case where there is a sliding door, then the appropriate code is to be specified as the whiteboard will not ship with the whiteboard mounting hardware as it will come with the sliding door. If there is no sliding door adjacent then the appropriate code will ensure mounting hardware is shipped. Whiteboards are powder coated with paint specially formulated for dry erase markers.

Only Expo Markers are to be used on any Inscape Whiteboard. Whiteboards should be cleaned with Expo Eraser or a Microfiber cleaning cloth along with Expo Cleaning Solution which is formulated to remove residue from Expo Dry Erase Markers.

Storwal storage back painted glass whiteboards

Storwal Storage Back Painted Glass Whiteboards are specified for the backs of Storwal Storage stack units. The glass is installed on-site and all additional hardware is included. Back Painted Glass Whiteboards come with a white back paint. Cannot be installed adjacent to a sliding door.

Electrical module side cover

Electrical Module Side Cover is specified for the end of an Storwal Storage unit to conceal the technology zone when a panel, screen or Cable Closet is not specified. This is a value engineered solution for the finishing of an Storwal Storage run. This cover may be painted the same colors as the Storwal Storage cases.

Electrical module front cover

An Electrical Module Front Cover is standard with all Storwal Storage base cases; one side with cut out and one side without. When the configuration of an Storwal Storage base unit calls for additional cut outs or no cut outs on the other side of the unit, the appropriate front cover may be specified. The 30" wide front cover only includes one cut out.

The Storwal Storage Adapter Frames provide a method of attaching various panel systems (3" or less) to Storwal Storage cases. The Adapter Frame Filler Kit installs between two Storwal Storage cases and an Adapter Frame End Kit installs on the end of a row of Storwal Storage cases. The adapter frames provide a surface to secure panel wall start brackets from other panel systems. Adapter frames are available in three heights to match Storwal Storage case heights.

Storwal storage to frame connecting brackets

Storwal Storage to Frame Connecting Brackets secure a frame to the Storwal Storage unit. There is a shared version for the 2.75" and 3.5" version and a 1.5" screen has its own bracket. When specifying the connection bracket for 2.75" and 3.5" the Filler Inserts (which ship as a pair) are required at each connecting location.





System

Accessories

Horizontal

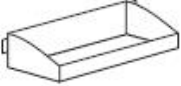
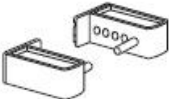

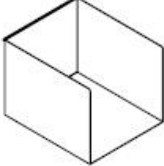
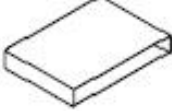
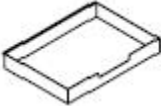

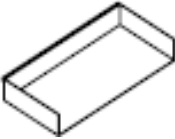
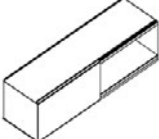

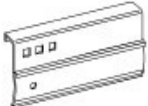

General information

- Horizontal Paper Management accessories hang on panel mounted or wall hung paper management tile

Description	Part number	Height	Width	Weight (lbs)	List price	Accent paint	
 Storage Compartment Acrylic	INSC4334	1 ½"	3"	0.1	\$21	—	
	INSC4534	1 ½"	5"	0.1	\$23	—	
	INSC4734	1 ½"	7"	0.1	\$24	—	
	INSC41134	1 ½"	11"	0.1	\$26	—	
 Hang file Brackets Acrylic	INSBKT	2"	1 ¼"	0.3	\$47	—	
 Slanted Sorter	INHLHSS left-handed	11 ¾"	2 ¼"	4	\$65	+\$8	
	INHRHSS right-handed (illustrated)	11 ¾"	2 ¼"	4	\$65	+\$8	
 Filing Box	INBTFB	9"	10"	2	\$112	+\$12	
 Storage Box	INBTSB	2"	12"	2	\$127	+\$14	
 Closed Shelf	INBTSHC	2"	12"	2	\$144	+\$16	
 Open Shelf	INBTSHF	2"	12"	2	\$96	+\$11	
 Open Shelf, Short	INBTSHFSH	2"	9"	2	\$96	+\$11	
 Personal Box	INBTPB	8"	32"	15	\$718	+\$230	+\$73

General information

- “2F” denotes use with 2 ¾” thick frame
- “3F” denotes use with 3 ½” thick frame
- Storage Catchall is available in black only
- Pencil Drawer is available in black only
- Pencil Drawer installed depth is 15 ¼” and the extended depth is 26”
- Table mounted shelf mounts to 1” or 1 ¼” thick worksurfaces and sits 7 ½” off the main worksurface

Description	Part number	Height	Width	Weight (lbs)	List price	Accent paint
 Signage (Qty of 6)	INPS2259-1	2 ¼”	9”	1	\$91	+\$10
 Coat Hook	INCOATHOOK-3F INCOATHOOK-2F	— —	— —	1 1	\$26 \$26	+\$4 +\$4
 Picture Hook	INPICHOOK-3F INPICHOOK-2F	— —	— —	1 1	\$23 \$23	+\$4 +\$4
 Storage Catchall	INTTO	2 ¼”	9 ¼”	1	\$44	—
 Pencil Drawer	INPPFD15 INPPFD22.75	— —	15” 22 ¾”	3 4	\$71 \$78	— —
 Panel Mounted Accessory Shelf	INPAS5.524 INPAS5.530 INPAS5.536 INPAS5.542 INPAS5.548 INPAS5.554 INPAS5.560	— — — — — — —	24” 30” 36” 42” 48” 54” 60”	3 3 3 3 4 4 4	\$174 \$183 \$193 \$202 \$216 \$223 \$232	+\$19 +\$19 +\$20 +\$21 +\$23 +\$23 +\$24
 ADDWALL Accessory Shelf	INPUSBA5.524 INPUSBA5.530 INPUSBA5.536 INPUSBA5.542 INPUSBA5.548 INPUSBA5.554 INPUSBA5.560	— — — — — — —	24” 30” 36” 42” 48” 54” 60”	3 3 3 3 4 4 4	\$174 \$183 \$193 \$202 \$216 \$223 \$232	+\$19 +\$19 +\$20 +\$21 +\$23 +\$23 +\$24
 Touch-up paint for standard enamel finishes Specify finish. Can contains a half pint	PAINT	0”	0”	0.5	\$37	—

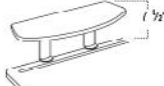
Description	Part number	Height	Width	Weight (lbs)	Nuform solid/ Neutral paint/ base price	Nuform woodgrain/ pattern	Accent paint upcharge
 Table Mounted Shelf	INTMS24 INTMS30 INTMS36 INTMS42	7 ½” 7 ½” 7 ½” 7 ½”	24” 30” 36” 42”	7 8 9 10	\$331 \$356 \$375 \$408	+\$13 +\$18 +\$23 +\$22	+\$34 +\$36 +\$38 +\$41

System

Accessories







Panel and Table

General information

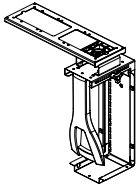
- “2F” denotes use with 2 ¾” thick frame
- “3F” denotes use with 3 ½” thick frame
- CPU holder mounts to the underside of a worksurface (See Inscape System Application Guide)



Notes

- Only Expo Markers are to be used on any Inscape Whiteboard. Whiteboards should be cleaned with Expo Eraser or a Microfiber cleaning cloth along with Expo Cleaning Solution which is formulated to remove residue from Expo Dry Erase Markers

Description	Part number	Height	Width	Weight (lbs)	List price
 CPU Holder	INAU200CU	14.5”-22.5”	3.5”-9.3”	13	\$333
	INAU300CU	14.5”-22.5”	3.5”-9.3”	13	\$405
 Tile Reveal Strips (Qty of 6)	INTRS13.5	—	—	0.1	\$25
	INTRSWG13.5	—	—	0.1	\$34
System Care Kit For use with 3 ½” T frames	INCAREKT-3F	—	—	—	\$120
	INCAREKT-2F	—	—	—	\$99
 13.5” H Panel Mounted Whiteboard For use with 3 ½” T frames	INWHBD24135-3F	13.5”	24”	10	\$239
	INWHBD30135-3F	13.5”	30”	13	\$247
	INWHBD36135-3F	13.5”	36”	14	\$254
	INWHBD42135-3F	13.5”	42”	16	\$264
	INWHBD48135-3F	13.5”	48”	18	\$270
 27” H Panel Mounted Whiteboard For use with 3 ½” T frames	INWHBD2427-3F	27”	24”	11	\$318
	INWHBD3027-3F	27”	30”	13	\$326
	INWHBD3627-3F	27”	36”	14	\$333
	INWHBD4227-3F	27”	42”	16	\$340
	INWHBD4827-3F	27”	48”	18	\$349
 13.5” H Panel Mounted Whiteboard For use with 2 ¾” T frames	INWHBD24135-2F	13.5”	24”	10	\$239
	INWHBD30135-2F	13.5”	30”	13	\$247
	INWHBD36135-2F	13.5”	36”	14	\$254
	INWHBD42135-2F	13.5”	42”	16	\$264
	INWHBD48135-2F	13.5”	48”	18	\$270
 27” H Panel Mounted Whiteboard For use with 2 ¾” T frames	INWHBD2427-2F	27”	24”	11	\$318
	INWHBD3027-2F	27”	30”	13	\$326
	INWHBD3627-2F	27”	36”	14	\$333
	INWHBD4227-2F	27”	42”	16	\$340
	INWHBD4827-2F	27”	48”	18	\$349

General information

- “2F” denotes use with 2 ¾” thick frame
- “3F” denotes use with 3 ½” thick frame
- Crossrails may be installed on a frame of the same thickness in pre-drilled locations in frame

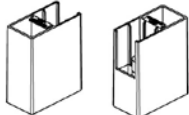
Description	Part number	Height	Width	Weight (lbs)	List price
 <p>Crossrail For use with 3 ½” T frames Includes tile clips</p>	INCRAIL18-3F	—	18”	1	\$24
	INCRAIL24-3F	—	24”	1	\$26
	INCRAIL30-3F	—	30”	1	\$29
	INCRAIL36-3F	—	36”	1	\$31
	INCRAIL42-3F	—	42”	2	\$33
	INCRAIL48-3F	—	48”	2	\$35
	INCRAIL54-3F	—	54”	2	\$39
	INCRAIL60-3F	—	60”	2	\$41
 <p>Crossrail For use with 2 ¾” T frames Includes tile clips</p>	INCRAIL18-2F	—	18”	1	\$24
	INCRAIL24-2F	—	24”	1	\$26
	INCRAIL30-2F	—	30”	1	\$29
	INCRAIL36-2F	—	36”	1	\$31
	INCRAIL42-2F	—	42”	2	\$33
	INCRAIL48-2F	—	48”	2	\$35
	INCRAIL54-2F	—	54”	2	\$39
	INCRAIL60-2F	—	60”	2	\$41
 <p>Rectangular Glide (Pair) Gray finish</p>	INFRMREC-GLIDE	—	—	—	\$43

Accessories

Modesty Panel

General information

- Modesty panels are available in a variety of materials and mounting options correspond with each variety
- Modesty panels mount to the underside of worksurface and are field installed
- See Application Guide for specific dimension detailed applications
- All hardware included
- Modesty panel use with a Height Adjustable Table, specify modesty panel 12" shorter in length than the surface
- Nuform finish is on one side with white backer

Notes

In order to get a total cost on products when upcharges are present take the list price of the product number and add the upcharge cost shown to the list price.

For example:

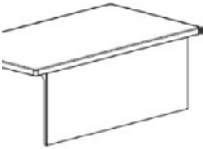

Product INMDPNW30 in Veneer would be \$270 +\$129

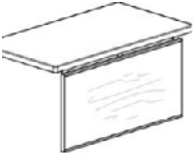
Description	Part number	Height	Width	Weight (lbs)	Neutral paint/ base price	Accent paint upcharge
 Painted Partial Height Modesty Panel	INMDPNP30	13 1/2"	30"	5	\$117	+\$13
	INMDPNP33	13 1/2"	33"	5.5	\$120	+\$13
	INMDPNP36	13 1/2"	36"	6	\$122	+\$13
	INMDPNP39	13 1/2"	39"	6.5	\$125	+\$14
	INMDPNP42	13 1/2"	42"	7	\$128	+\$14
	INMDPNP45	13 1/2"	45"	7.5	\$131	+\$14
	INMDPNP48	13 1/2"	48"	8	\$137	+\$15
	INMDPNP51	13 1/2"	51"	8.5	\$139	+\$15
	INMDPNP54	13 1/2"	54"	9	\$141	+\$15
	INMDPNP57	13 1/2"	57"	9.5	\$144	+\$16
	INMDPNP60	13 1/2"	60"	10	\$146	+\$16
	INMDPNP63	13 1/2"	63"	10.5	\$148	+\$16
	INMDPNP66	13 1/2"	66"	11	\$150	+\$16
	INMDPNP69	13 1/2"	69"	11.5	\$151	+\$16
INMDPNP72	13 1/2"	72"	12	\$154	+\$17	

Description	Part number	Height	Width	Weight (lbs)	Nuform	Laminate	Grade 1 laminate	Veneer	Accent paint
 Wood Core Partial Height Modesty Panel	INMDPNW30	13 1/2"	30"	12	\$270	\$270	+\$87	+\$129	+\$28
	INMDPNW33	13 1/2"	33"	13	\$290	\$290	+\$93	+\$131	+\$30
	INMDPNW36	13 1/2"	36"	14	\$297	\$297	+\$96	+\$144	+\$31
	INMDPNW39	13 1/2"	39"	15	\$332	\$332	+\$107	+\$128	+\$34
	INMDPNW42	13 1/2"	42"	16	\$338	\$338	+\$109	+\$143	+\$35
	INMDPNW45	13 1/2"	45"	17.5	\$347	\$347	+\$112	+\$156	+\$36
	INMDPNW48	13 1/2"	48"	19	\$353	\$353	+\$113	+\$178	+\$36
	INMDPNW51	13 1/2"	51"	20	\$387	\$387	+\$124	+\$163	+\$40
	INMDPNW54	13 1/2"	54"	21	\$393	\$393	+\$126	+\$184	+\$40
	INMDPNW57	13 1/2"	57"	22	\$402	\$402	+\$129	+\$196	+\$41
	INMDPNW60	13 1/2"	60"	23.5	\$422	\$422	+\$136	+\$196	+\$43
	INMDPNW63	13 1/2"	63"	24.5	\$493	\$493	+\$158	+\$147	+\$50
	INMDPNW66	13 1/2"	66"	26	\$514	\$514	+\$165	+\$147	+\$52
	INMDPNW69	13 1/2"	69"	27	\$533	\$533	+\$171	+\$148	+\$54
	INMDPNW72	13 1/2"	72"	28	\$554	\$554	+\$178	+\$155	+\$56
	INMDPNW75	13 1/2"	75"	29	\$617	\$617	+\$198	+\$113	+\$62
	INMDPNW78	13 1/2"	78"	30.5	\$622	\$622	+\$200	+\$129	+\$63
	INMDPNW81	13 1/2"	81"	31.5	\$629	\$629	+\$202	+\$144	+\$63
	INMDPNW84	13 1/2"	84"	33	\$633	\$633	+\$203	+\$160	+\$64
INMDPNW87	13 1/2"	87"	34	\$638	\$638	+\$205	+\$174	+\$64	
INMDPNW90	13 1/2"	90"	35	\$642	\$642	+\$206	+\$189	+\$65	

General information

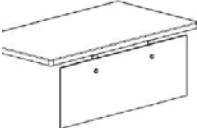
- Modesty panels are available in a variety of materials and mounting options correspond with each variety
- Modesty panels mount to the underside of worksurface and are field installed
- See Application Guide for specific dimension detailed applications
- All hardware included
- Modesty panel use with a Height Adjustable Table, specify modesty panel 12" shorter in length than the surface

Description	Part number	Height	Width	Weight (lbs)	Neutral paint/ base price	Accent paint
	Acrylic Partial Height Modesty Panel					
	INMDPNA30	13 1/2"	30"	4	\$444	+\$45
	INMDPNA33	13 1/2"	33"	4.5	\$448	+\$46
	INMDPNA36	13 1/2"	36"	5	\$455	+\$46
	INMDPNA39	13 1/2"	39"	5.5	\$460	+\$47
	INMDPNA42	13 1/2"	42"	6	\$466	+\$47
	INMDPNA45	13 1/2"	45"	6	\$476	+\$48
	INMDPNA48	13 1/2"	48"	6.5	\$481	+\$49
	INMDPNA51	13 1/2"	51"	7	\$501	+\$51
	INMDPNA54	13 1/2"	54"	7.5	\$524	+\$53
	INMDPNA57	13 1/2"	57"	8	\$544	+\$55
	INMDPNA60	13 1/2"	60"	8	\$572	+\$58
	INMDPNA63	13 1/2"	63"	8.5	\$598	+\$60
	INMDPNA66	13 1/2"	66"	9	\$627	+\$63
	INMDPNA69	13 1/2"	69"	9.5	\$652	+\$66
	INMDPNA72	13 1/2"	72"	10	\$681	+\$69
	INMDPNA75	13 1/2"	75"	10	\$694	+\$71
	INMDPNA78	13 1/2"	78"	10.5	\$710	+\$72
	INMDPNA81	13 1/2"	81"	11	\$724	+\$74
	INMDPNA84	13 1/2"	84"	11.5	\$740	+\$75
INMDPNA87	13 1/2"	87"	12	\$755	+\$77	
INMDPNA90	13 1/2"	90"	12	\$771	+\$78	
	Frame Frosted Acrylic Partial Height Modesty Panel					
	INMDPNG30	13 1/2"	30"	4.3	\$666	+\$67
	INMDPNG33	13 1/2"	33"	4.7	\$689	+\$70
	INMDPNG36	13 1/2"	36"	5	\$710	+\$72
	INMDPNG39	13 1/2"	39"	5.4	\$732	+\$75
	INMDPNG42	13 1/2"	42"	5.7	\$753	+\$77
	INMDPNG45	13 1/2"	45"	6.1	\$776	+\$79
	INMDPNG48	13 1/2"	48"	6.4	\$797	+\$81
	INMDPNG51	13 1/2"	51"	6.8	\$820	+\$83
	INMDPNG54	13 1/2"	54"	7.1	\$841	+\$85
	INMDPNG57	13 1/2"	57"	7.5	\$862	+\$87
	INMDPNG60	13 1/2"	60"	7.9	\$885	+\$90
	INMDPNG63	13 1/2"	63"	8.2	\$1032	+\$104
	INMDPNG66	13 1/2"	66"	8.6	\$1053	+\$106
	INMDPNG69	13 1/2"	69"	8.9	\$1075	+\$108
	INMDPNG72	13 1/2"	72"	9.3	\$1098	+\$111
	INMDPNG75	13 1/2"	75"	9.6	\$1119	+\$113
	INMDPNG78	13 1/2"	78"	10	\$1139	+\$115
	INMDPNG81	13 1/2"	81"	10.4	\$1163	+\$117
	INMDPNG84	13 1/2"	84"	10.7	\$1183	+\$119
INMDPNG87	13 1/2"	87"	11.1	\$1207	+\$121	
INMDPNG90	13 1/2"	90"	11.4	\$1229	+\$123	

Accessories

Modesty Panel

General information

- Modesty panels are available in a variety of materials and mounting options correspond with each variety
- Modesty panels mount to the underside of worksurface and are field installed
- See Application Guide for specific dimension detailed applications
- All hardware included
- Modesty panel use with a Height Adjustable Table, specify modesty panel 12" shorter in length than the surface
- Nuform finish is on one side with white backer

Notes

In order to get a total cost on products when upcharges are present take the list price of the product number and add the upcharge cost shown to the list price.

For example:

Product INMDFHPNW30 in Veneer would be \$349 +\$221

Description	Part number	Height	Width	Weight (lbs)	Nuform	Laminate	Grade 1 laminate	Veneer	Accent paint
	Wood Core Full Height Modesty Panel								
	INMDFHPNW30	24"	30"	21.5	\$349	\$349	+\$112	+\$221	+\$36
	INMDFHPNW33	24"	33"	23.6	\$380	\$380	+\$122	+\$226	+\$39
	INMDFHPNW36	24"	36"	25.8	\$388	\$388	+\$125	+\$253	+\$40
	INMDFHPNW39	24"	39"	27.9	\$443	\$443	+\$142	+\$237	+\$45
	INMDFHPNW42	24"	42"	30.1	\$452	\$452	+\$145	+\$265	+\$46
	INMDFHPNW45	24"	45"	32.3	\$404	\$404	+\$130	+\$350	+\$41
	INMDFHPNW48	24"	48"	34.4	\$470	\$470	+\$151	+\$329	+\$48
	INMDFHPNW51	24"	51"	36.6	\$582	\$582	+\$187	+\$255	+\$59
	INMDFHPNW54	24"	54"	38.7	\$592	\$592	+\$190	+\$292	+\$60
	INMDFHPNW57	24"	57"	40.9	\$600	\$600	+\$192	+\$320	+\$61
	INMDFHPNW60	24"	60"	47	\$616	\$616	+\$198	+\$341	+\$62
	INMDFHPNW63	24"	63"	45.2	\$642	\$642	+\$206	+\$351	+\$65
	INMDFHPNW66	24"	66"	47.3	\$659	\$659	+\$211	+\$371	+\$66
	INMDFHPNW69	24"	69"	49.5	\$678	\$678	+\$217	+\$392	+\$69
	INMDFHPNW72	24"	72"	51.7	\$691	\$691	+\$222	+\$422	+\$70
	INMDFHPNW75	24"	75"	52.8	\$789	\$789	+\$253	+\$362	+\$80
	INMDFHPNW78	24"	78"	56	\$795	\$795	+\$255	+\$393	+\$81
	INMDFHPNW81	24"	81"	58.1	\$800	\$800	+\$256	+\$425	+\$81
	INMDFHPNW84	24"	84"	60.3	\$805	\$805	+\$258	+\$455	+\$82
INMDFHPNW87	24"	87"	62.4	\$809	\$809	+\$259	+\$488	+\$82	
INMDFHPNW90	24"	90"	64.6	\$818	\$818	+\$262	+\$517	+\$83	

Description	Part number	Height	Width	Weight (lbs)	Neutral paint/ base price	Accent paint
	Frame Frosted Acrylic Full Height Modesty Panel					
	INMDFHPNG30	24"	30"	6.4	\$795	+\$81
	INMDFHPNG33	24"	33"	6.9	\$826	+\$84
	INMDFHPNG36	24"	36"	7.4	\$857	+\$87
	INMDFHPNG39	24"	39"	7.9	\$890	+\$90
	INMDFHPNG42	24"	42"	8.4	\$919	+\$93
	INMDFHPNG45	24"	45"	8.9	\$952	+\$96
	INMDFHPNG48	24"	48"	9.4	\$983	+\$99
	INMDFHPNG51	24"	51"	9.9	\$1014	+\$102
	INMDFHPNG54	24"	54"	10.4	\$1046	+\$105
	INMDFHPNG57	24"	57"	10.9	\$1076	+\$108
	INMDFHPNG60	24"	60"	11.4	\$1108	+\$112
	INMDFHPNG63	24"	63"	11.9	\$1265	+\$127
	INMDFHPNG66	24"	66"	12.5	\$1297	+\$130
	INMDFHPNG69	24"	69"	13	\$1327	+\$133
	INMDFHPNG72	24"	72"	13.5	\$1360	+\$137
	INMDFHPNG75	24"	75"	14	\$1390	+\$140
	INMDFHPNG78	24"	78"	14.5	\$1423	+\$144
	INMDFHPNG81	24"	81"	15	\$1455	+\$147
	INMDFHPNG84	24"	84"	15.5	\$1483	+\$150
INMDFHPNG87	24"	87"	16	\$1516	+\$153	
INMDFHPNG90	24"	90"	16.5	\$1544	+\$156	

General information

- Table mounted screens mount to worksurfaces
- It is recommended that the Adjustable Framed Table Mounted Screen is installed to allow 20" of visual privacy
- Freestanding Table Screen is made of 6mm thick frosted acrylic which is 13" high, seated in a painted aluminum extrusion, which can be painted any of Inscape's standard colors. This screen is 5" less in depth than depth of worksurface it will be placed on
- Table Mounted Screen/Modesty has 14" of the tackboard mounted above the surface and 13 1/2" below

Notes

In order to get a total cost on products when upcharges are present take the list price of the product number and add the upcharge cost shown to the list price.

For example:

Product MST3736 in Grade 5 Fabric would be \$529 +\$134

Product SWTMS48 in White Acrylic would be \$755 +\$91

Description	Part number	Height	Width	Weight (lbs)	Grade 1/ COM/ base price	Grade 2	Grade 3	Grade 4	Grade 5	Grade 6	Grade 7	Grade 8	Accent paint
	MST3736	37"	36"	13	\$529	+\$49	+\$77	—	+\$134	—	+\$370	—	+\$54
	MST3742	37"	42"	15	\$551	+\$50	+\$78	—	+\$134	—	+\$374	—	+\$56
	MST3748	37"	48"	16	\$573	+\$55	+\$79	—	+\$135	—	+\$378	—	+\$58
	MST3754	37"	54"	18	\$593	+\$57	+\$84	—	+\$138	—	+\$387	—	+\$60
	MST3760	37"	60"	19	\$614	+\$62	+\$89	—	+\$138	—	+\$396	—	+\$62

37" H Adjustable Framed Table Mounted Screen Tackable

Description	Part number	Height	Width	Weight (lbs)	Clear acrylic	White acrylic	Frosted acrylic
	SWTMS48	20"	48"	4	\$755	+\$91	+\$89
	SWTMS54	20"	54"	5	\$1185	+\$190	+\$186
	SWTMS60	20"	60"	6	\$1373	+\$189	+\$185

Description	Part number	Height	Width	Weight (lbs)	List price	Accent paint
	INSPS24	13"	19"	2	\$104	+\$12
	INSPS30	13"	25"	2.5	\$146	+\$16
	INSPS32	13"	28"	3	\$153	+\$16
	INSPS36	13"	31"	3.5	\$159	+\$17

Description	Part number	Height	Width	Weight (lbs)	Grade A/ base price	Grade B/ COM	Grade C	Grade D	Grade E	Grade F	Accent paint
	INTMSF2948	29"	48"	—	\$1117	+\$158	+\$434	+\$842	+\$1015	+\$1387	+\$112
	INTMSF2954	29"	54"	—	\$1133	+\$307	+\$601	+\$1020	+\$1215	+\$1706	+\$114
	INTMSF2960	29"	60"	—	\$1209	+\$353	+\$680	+\$1138	+\$1356	+\$1897	+\$122

Table Mounted Screen/Modesty Tackable

System

Accessories

Add-on Glazing

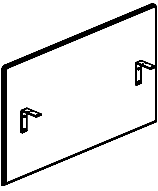
3 1/2" T

General information

- "2F" denotes use with 2 3/4" thick frame
"3F" denotes use with 3 1/2" thick frame
- Add-on Glazing comes complete with mounting hardware and top cap
- Add-on Glazing may span multiple frames according to guidelines set in the "Inscape System Application Guide"
- One glaze Alignment clip is included with each Add on Glazing
- Add-on Glazing up to 60" w require two additional Jesters to be specified if spanning multiple frames (ie a 60" w AOG installed on 2-30" frames)
- **Tapered is not available in 66" or wider**
- **List/Base for 0.25" thick is clear glass**
- **0.38" thick is NOT available in tapered**

Notes

In order to get a total cost on products when upcharges are present take the list price of the product number and add the upcharge cost shown to the list price.

For example:

Product INAG6.7518-3F 0.25" thick glass with Gray would be \$138 +\$79

The same product upgraded to 0.38" thick glass would be \$138 +\$67 +\$184

Description	Part number	Width	List/base /0.25" thick glazing price	Glazing thickness option		0.25" thick finish options				0.38" thick finish options		
				0.38" thick glazing	Clear	Gray	Etched 1 side	Etched 2 side	Clear	Gray	Etched 1 side	Accent paint
6.75" H Add-On Glazing For use with 3 1/2" T frames	INAG6.7518-3F	18"	\$138	+\$67	\$0	+\$79	+\$79	+\$145	+\$0	+\$184	+\$184	+\$15
	INAG6.7524-3F	24"	\$171	+\$84	\$0	+\$76	+\$76	+\$146	+\$0	+\$195	+\$195	+\$18
	INAG6.7530-3F	30"	\$195	+\$97	\$0	+\$94	+\$94	+\$185	+\$0	+\$236	+\$236	+\$21
	INAG6.7536-3F	36"	\$215	+\$106	\$0	+\$102	+\$102	+\$226	+\$0	+\$257	+\$257	+\$23
	INAG6.7542-3F	42"	\$230	+\$114	\$0	+\$106	+\$106	+\$234	+\$0	+\$270	+\$270	+\$24
	INAG6.7548-3F	48"	\$248	+\$121	\$0	+\$110	+\$110	+\$239	+\$0	+\$286	+\$286	+\$26
	INAG6.7554-3F	54"	\$265	+\$131	\$0	+\$113	+\$113	+\$243	+\$0	+\$298	+\$298	+\$28
	INAG6.7560-3F	60"	\$286	+\$141	\$0	+\$125	+\$125	+\$269	+\$0	+\$327	+\$327	+\$30
	INAG6.7566-3F	66"	\$296	+\$145	\$0	+\$155	+\$155	+\$292	+\$0	+\$377	+\$377	+\$31
	INAG6.7572-3F	72"	\$311	+\$154	\$0	+\$172	+\$172	+\$320	+\$0	+\$410	+\$410	+\$32
	INAG6.7578-3F	78"	\$397	+\$194	\$0	+\$133	+\$133	+\$274	+\$0	+\$394	+\$394	+\$41
	INAG6.7584-3F	84"	\$464	+\$228	\$0	+\$111	+\$111	+\$245	+\$0	+\$394	+\$394	+\$47
INAG6.7590-3F	90"	\$532	+\$262	\$0	+\$88	+\$88	+\$217	+\$0	+\$394	+\$394	+\$54	
INAG6.7596-3F	96"	\$600	+\$295	\$0	+\$66	+\$66	+\$189	+\$0	+\$394	+\$394	+\$61	
6.75" H Hi-Lo Add-On Glazing For use with 3 1/2" T frames	INAGHL6.7518-3F	18"	\$138	+\$67	\$0	+\$79	+\$79	+\$145	+\$0	+\$184	+\$184	+\$15
	INAGHL6.7524-3F	24"	\$171	+\$84	\$0	+\$76	+\$76	+\$146	+\$0	+\$195	+\$195	+\$18
	INAGHL6.7530-3F	30"	\$195	+\$97	\$0	+\$94	+\$94	+\$185	+\$0	+\$236	+\$236	+\$21
	INAGHL6.7536-3F	36"	\$215	+\$106	\$0	+\$102	+\$102	+\$226	+\$0	+\$257	+\$257	+\$23
	INAGHL6.7542-3F	42"	\$230	+\$114	\$0	+\$106	+\$106	+\$234	+\$0	+\$270	+\$270	+\$24
	INAGHL6.7548-3F	48"	\$248	+\$121	\$0	+\$110	+\$110	+\$239	+\$0	+\$286	+\$286	+\$26
	INAGHL6.7554-3F	54"	\$265	+\$131	\$0	+\$113	+\$113	+\$243	+\$0	+\$298	+\$298	+\$28
	INAGHL6.7560-3F	60"	\$286	+\$141	\$0	+\$125	+\$125	+\$269	+\$0	+\$327	+\$327	+\$30
	INAGHL6.7566-3F	66"	\$296	+\$145	\$0	+\$155	+\$155	+\$292	+\$0	+\$377	+\$377	+\$31
	INAGHL6.7572-3F	72"	\$311	+\$154	\$0	+\$172	+\$172	+\$320	+\$0	+\$410	+\$410	+\$32
	INAGHL6.7578-3F	78"	\$397	+\$194	\$0	+\$133	+\$133	+\$274	+\$0	+\$394	+\$394	+\$41
	INAGHL6.7584-3F	84"	\$464	+\$228	\$0	+\$111	+\$111	+\$245	+\$0	+\$394	+\$394	+\$47
INAGHL6.7590-3F	90"	\$532	+\$262	\$0	+\$88	+\$88	+\$217	+\$0	+\$394	+\$394	+\$54	
INAGHL6.7596-3F	96"	\$600	+\$295	\$0	+\$66	+\$66	+\$189	+\$0	+\$394	+\$394	+\$61	
13.5" H Add-On Glazing For use with 3 1/2" T frames	INAG13.518-3F	18"	\$146	+\$73	\$0	+\$75	+\$75	+\$139	+\$0	+\$182	+\$182	+\$16
	INAG13.524-3F	24"	\$173	+\$85	\$0	+\$77	+\$77	+\$148	+\$0	+\$197	+\$197	+\$18
	INAG13.530-3F	30"	\$197	+\$98	\$0	+\$97	+\$97	+\$186	+\$0	+\$240	+\$240	+\$21
	INAG13.536-3F	36"	\$223	+\$110	\$0	+\$115	+\$115	+\$224	+\$0	+\$282	+\$282	+\$23
	INAG13.542-3F	42"	\$249	+\$123	\$0	+\$134	+\$134	+\$261	+\$0	+\$323	+\$323	+\$26
	INAG13.548-3F	48"	\$275	+\$135	\$0	+\$154	+\$154	+\$298	+\$0	+\$366	+\$366	+\$28
	INAG13.554-3F	54"	\$301	+\$148	\$0	+\$172	+\$172	+\$333	+\$0	+\$404	+\$404	+\$31
	INAG13.560-3F	60"	\$327	+\$161	\$0	+\$191	+\$191	+\$371	+\$0	+\$447	+\$447	+\$34
	INAG13.566-3F	66"	\$352	+\$173	\$0	+\$212	+\$212	+\$400	+\$0	+\$488	+\$488	+\$36
	INAG13.572-3F	72"	\$409	+\$199	\$0	+\$191	+\$191	+\$378	+\$0	+\$487	+\$487	+\$42
	INAG13.578-3F	78"	\$466	+\$229	\$0	+\$180	+\$180	+\$359	+\$0	+\$497	+\$497	+\$47
	INAG13.584-3F	84"	\$526	+\$258	\$0	+\$169	+\$169	+\$341	+\$0	+\$510	+\$510	+\$53
INAG13.590-3F	90"	\$584	+\$288	\$0	+\$150	+\$150	+\$323	+\$0	+\$510	+\$510	+\$59	
INAG13.596-3F	96"	\$644	+\$318	\$0	+\$138	+\$138	+\$302	+\$0	+\$521	+\$521	+\$65	

General information

- "2F" denotes use with 2 3/4" thick frame
- "3F" denotes use with 3 1/2" thick frame
- Add-on Glazing comes complete with mounting hardware and top cap
- Add-on Glazing may span multiple frames according to guidelines set in the "Inscape System Application Guide"
- One glaze Alignment clip is included with each Add on Glazing
- Add-on Glazing up to 60"w require two additional Jesters to be specified if spanning multiple frames (ie a 60"w AOG installed on 2-30" frames)
- **Tapered is not available in 66" or wider**
- **List/Base for 0.25" thick is clear glass**
- **0.38" thick is NOT available in tapered**

Notes



In order to get a total cost on products when upcharges are present take the list price of the product number and add the upcharge cost shown to the list price.

For example:

Product INAGHL13.518-3F 0.25" thick glass with Gray would be \$146 +\$75

The same product upgraded to 0.38" thick glass would be \$146 +\$73 +\$182

Description	Part number	Width	List/base /0.25" thick glazing price	Glazing thickness option	0.25" thick finish options				0.38" thick finish options			
				0.38" thick glazing	Clear	Gray	Etched 1 side	Etched 2 side	Clear	Gray	Etched 1 side	Accent paint
 <p>13.5" H Hi-Lo Add-On Glazing For use with 3 1/2" T frames</p>	INAGHL13.518-3F	18"	\$146	+\$73	\$0	+\$75	+\$75	+\$139	+\$0	+\$182	+\$182	+\$16
	INAGHL13.524-3F	24"	\$173	+\$85	\$0	+\$77	+\$77	+\$148	+\$0	+\$197	+\$197	+\$18
	INAGHL13.530-3F	30"	\$197	+\$98	\$0	+\$97	+\$97	+\$186	+\$0	+\$240	+\$240	+\$21
	INAGHL13.536-3F	36"	\$223	+\$110	\$0	+\$115	+\$115	+\$224	+\$0	+\$282	+\$282	+\$23
	INAGHL13.542-3F	42"	\$249	+\$123	\$0	+\$134	+\$134	+\$261	+\$0	+\$323	+\$323	+\$26
	INAGHL13.548-3F	48"	\$275	+\$135	\$0	+\$154	+\$154	+\$298	+\$0	+\$366	+\$366	+\$28
	INAGHL13.554-3F	54"	\$301	+\$148	\$0	+\$172	+\$172	+\$333	+\$0	+\$404	+\$404	+\$31
	INAGHL13.560-3F	60"	\$327	+\$161	\$0	+\$191	+\$191	+\$371	+\$0	+\$447	+\$447	+\$34
	INAGHL13.566-3F	66"	\$352	+\$173	\$0	+\$212	+\$212	+\$400	+\$0	+\$488	+\$488	+\$36
	INAGHL13.572-3F	72"	\$409	+\$199	\$0	+\$191	+\$191	+\$378	+\$0	+\$487	+\$487	+\$42
	INAGHL13.578-3F	78"	\$466	+\$229	\$0	+\$180	+\$180	+\$359	+\$0	+\$497	+\$497	+\$47
	INAGHL13.584-3F	84"	\$526	+\$258	\$0	+\$169	+\$169	+\$341	+\$0	+\$510	+\$510	+\$53
	INAGHL13.590-3F	90"	\$584	+\$288	\$0	+\$150	+\$150	+\$323	+\$0	+\$510	+\$510	+\$59
	INAGHL13.596-3F	96"	\$644	+\$318	\$0	+\$138	+\$138	+\$302	+\$0	+\$521	+\$521	+\$65

Description	Part number	List price
 <p>Add-On Glazing Top Cap Clip for 3 1/2" T Flat Trim Applications</p>	QCCLIPASSY-3F	\$6
 <p>Add-On Glazing Top Cap Clip for 3 1/2" T Tapered Trim Applications</p>	QCCLIPASSY-3FT	\$5

System

Accessories

Add-on Glazing

2 3/4" T

General information

- "2F" denotes use with 2 3/4" thick frame
"3F" denotes use with 3 1/2" thick frame
- Add-on Glazing comes complete with mounting hardware and top cap
- Add-on Glazing may span multiple frames according to guidelines set in the "Inscape System Application Guide"
- One glaze Alignment clip is included with each Add on Glazing
- Add-on Glazing up to 60" w require two additional Jesters to be specified if spanning multiple frames (ie a 60" w AOG installed on 2-30" frames)
- **Tapered is not available in 2 3/4" T**
- **List/Base for 0.25" thick is clear glass**
- **0.38" thick is NOT available in tapered**



Notes

In order to get a total cost on products when upcharges are present take the list price of the product number and add the upcharge cost shown to the list price.

For example:

Product INAG6.7518-2F 0.25" thick glass with Gray would be \$138 +\$79

The same product upgraded to 0.38" thick glass would be \$138 +\$67 +\$184

Description	Part number	Width	List/base /0.25" thick glazing price	Glazing thickness option		0.25" thick finish options				0.38" thick finish options		
				0.38" thick glazing	Clear	Gray	Etched 1 side	Etched 2 side	Clear	Gray	Etched 1 side	Accent paint
 <p>6.75" H Add-On Glazing For use with 2 3/4" T frames</p>	INAG6.7518-2F	18"	\$138	+\$67	\$0	+\$79	+\$79	+\$145	+\$0	+\$184	+\$184	+\$15
	INAG6.7524-2F	24"	\$171	+\$84	\$0	+\$76	+\$76	+\$146	+\$0	+\$195	+\$195	+\$18
	INAG6.7530-2F	30"	\$195	+\$97	\$0	+\$94	+\$94	+\$185	+\$0	+\$236	+\$236	+\$21
	INAG6.7536-2F	36"	\$215	+\$106	\$0	+\$102	+\$102	+\$226	+\$0	+\$257	+\$257	+\$23
	INAG6.7542-2F	42"	\$230	+\$114	\$0	+\$106	+\$106	+\$234	+\$0	+\$270	+\$270	+\$24
	INAG6.7548-2F	48"	\$248	+\$121	\$0	+\$110	+\$110	+\$239	+\$0	+\$286	+\$286	+\$26
	INAG6.7554-2F	54"	\$265	+\$131	\$0	+\$113	+\$113	+\$243	+\$0	+\$298	+\$298	+\$28
	INAG6.7560-2F	60"	\$286	+\$141	\$0	+\$125	+\$125	+\$269	+\$0	+\$327	+\$327	+\$30
	INAG6.7566-2F	66"	\$296	+\$145	\$0	+\$155	+\$155	+\$292	+\$0	+\$377	+\$377	+\$31
	INAG6.7572-2F	72"	\$311	+\$154	\$0	+\$172	+\$172	+\$320	+\$0	+\$410	+\$410	+\$32
	INAG6.7578-2F	78"	\$397	+\$194	\$0	+\$133	+\$133	+\$274	+\$0	+\$394	+\$394	+\$41
	INAG6.7584-2F	84"	\$464	+\$228	\$0	+\$111	+\$111	+\$245	+\$0	+\$394	+\$394	+\$47
INAG6.7590-2F	90"	\$532	+\$262	\$0	+\$88	+\$88	+\$217	+\$0	+\$394	+\$394	+\$54	
INAG6.7596-2F	96"	\$600	+\$295	\$0	+\$66	+\$66	+\$189	+\$0	+\$394	+\$394	+\$61	
 <p>6.75" H Hi-Lo Add-On Glazing For use with 2 3/4" T frames</p>	INAGHL6.7518-2F	18"	\$138	+\$67	\$0	+\$79	+\$79	+\$145	+\$0	+\$184	+\$184	+\$15
	INAGHL6.7524-2F	24"	\$171	+\$84	\$0	+\$76	+\$76	+\$146	+\$0	+\$195	+\$195	+\$18
	INAGHL6.7530-2F	30"	\$195	+\$97	\$0	+\$94	+\$94	+\$185	+\$0	+\$236	+\$236	+\$21
	INAGHL6.7536-2F	36"	\$215	+\$106	\$0	+\$102	+\$102	+\$226	+\$0	+\$257	+\$257	+\$23
	INAGHL6.7542-2F	42"	\$230	+\$114	\$0	+\$106	+\$106	+\$234	+\$0	+\$270	+\$270	+\$24
	INAGHL6.7548-2F	48"	\$248	+\$121	\$0	+\$110	+\$110	+\$239	+\$0	+\$286	+\$286	+\$26
	INAGHL6.7554-2F	54"	\$265	+\$131	\$0	+\$113	+\$113	+\$243	+\$0	+\$298	+\$298	+\$28
	INAGHL6.7560-2F	60"	\$286	+\$141	\$0	+\$125	+\$125	+\$269	+\$0	+\$327	+\$327	+\$30
	INAGHL6.7566-2F	66"	\$296	+\$145	\$0	+\$155	+\$155	+\$292	+\$0	+\$377	+\$377	+\$31
	INAGHL6.7572-2F	72"	\$311	+\$154	\$0	+\$172	+\$172	+\$320	+\$0	+\$410	+\$410	+\$32
	INAGHL6.7578-2F	78"	\$397	+\$194	\$0	+\$133	+\$133	+\$274	+\$0	+\$394	+\$394	+\$41
	INAGHL6.7584-2F	84"	\$464	+\$228	\$0	+\$111	+\$111	+\$245	+\$0	+\$394	+\$394	+\$47
INAGHL6.7590-2F	90"	\$532	+\$262	\$0	+\$88	+\$88	+\$217	+\$0	+\$394	+\$394	+\$54	
INAGHL6.7596-2F	96"	\$600	+\$295	\$0	+\$66	+\$66	+\$189	+\$0	+\$394	+\$394	+\$61	
 <p>13.5" H Add-On Glazing For use with 2 3/4" T frames</p>	INAG13.518-2F	18"	\$146	+\$73	\$0	+\$75	+\$75	+\$139	+\$0	+\$182	+\$182	+\$16
	INAG13.524-2F	24"	\$173	+\$85	\$0	+\$77	+\$77	+\$148	+\$0	+\$197	+\$197	+\$18
	INAG13.530-2F	30"	\$197	+\$98	\$0	+\$97	+\$97	+\$186	+\$0	+\$240	+\$240	+\$21
	INAG13.536-2F	36"	\$223	+\$110	\$0	+\$115	+\$115	+\$224	+\$0	+\$282	+\$282	+\$23
	INAG13.542-2F	42"	\$249	+\$123	\$0	+\$134	+\$134	+\$261	+\$0	+\$323	+\$323	+\$26
	INAG13.548-2F	48"	\$275	+\$135	\$0	+\$154	+\$154	+\$298	+\$0	+\$366	+\$366	+\$28
	INAG13.554-2F	54"	\$301	+\$148	\$0	+\$172	+\$172	+\$333	+\$0	+\$404	+\$404	+\$31
	INAG13.560-2F	60"	\$327	+\$161	\$0	+\$191	+\$191	+\$371	+\$0	+\$447	+\$447	+\$34
	INAG13.566-2F	66"	\$352	+\$173	\$0	+\$212	+\$212	+\$400	+\$0	+\$488	+\$488	+\$36
	INAG13.572-2F	72"	\$409	+\$199	\$0	+\$191	+\$191	+\$409	+\$0	+\$487	+\$487	+\$42
	INAG13.578-2F	78"	\$466	+\$229	\$0	+\$180	+\$180	+\$359	+\$0	+\$497	+\$497	+\$47
	INAG13.584-2F	84"	\$526	+\$258	\$0	+\$169	+\$169	+\$341	+\$0	+\$510	+\$510	+\$53
INAG13.590-2F	90"	\$584	+\$288	\$0	+\$150	+\$150	+\$323	+\$0	+\$510	+\$510	+\$59	
INAG13.596-2F	96"	\$644	+\$318	\$0	+\$138	+\$138	+\$302	+\$0	+\$521	+\$521	+\$65	

General information

- "2F" denotes use with 2 3/4" thick frame
- "3F" denotes use with 3 1/2" thick frame
- Add-on Glazing comes complete with mounting hardware and top cap
- Add-on Glazing may span multiple frames according to guidelines set in the "Inscape System Application Guide"
- One glaze Alignment clip is included with each Add on Glazing
- Add-on Glazing up to 60"w require two additional Jesters to be specified if spanning multiple frames (ie a 60"w AOG installed on 2-30" frames)
- **Tapered is not available in 2 3/4" T**
- **List/Base for 0.25" thick is clear glass**
- **0.38" thick is NOT available in tapered**

Notes

In order to get a total cost on products when upcharges are present take the list price of the product number and add the upcharge cost shown to the list price.

For example:

Product INAGHL13.518-2F 0.25" thick glass with Gray would be \$146 +\$75

The same product upgraded to 0.38" thick glass would be \$146 +\$73 +\$182

Description	Part number	Width	List/base /0.25" thick glazing price	Glazing thickness option	0.25" thick finish options				0.38" thick finish options			
				0.38" thick glazing	Clear	Gray	Etched 1 side	Etched 2 side	Clear	Gray	Etched 1 side	Accent paint
 <p>13.5" H Hi-Lo Add-On Glazing For use with 2 3/4" T frames</p>	INAGHL13.518-2F	18"	\$146	+\$73	\$0	+\$75	+\$75	+\$139	+\$0	+\$182	+\$182	+\$16
	INAGHL13.524-2F	24"	\$173	+\$85	\$0	+\$77	+\$77	+\$148	+\$0	+\$197	+\$197	+\$18
	INAGHL13.530-2F	30"	\$197	+\$98	\$0	+\$97	+\$97	+\$186	+\$0	+\$240	+\$240	+\$21
	INAGHL13.536-2F	36"	\$223	+\$110	\$0	+\$115	+\$115	+\$224	+\$0	+\$282	+\$282	+\$23
	INAGHL13.542-2F	42"	\$249	+\$123	\$0	+\$134	+\$134	+\$261	+\$0	+\$323	+\$323	+\$26
	INAGHL13.548-2F	48"	\$275	+\$135	\$0	+\$154	+\$154	+\$298	+\$0	+\$366	+\$366	+\$28
	INAGHL13.554-2F	54"	\$301	+\$148	\$0	+\$172	+\$172	+\$333	+\$0	+\$404	+\$404	+\$31
	INAGHL13.560-2F	60"	\$327	+\$161	\$0	+\$191	+\$191	+\$371	+\$0	+\$447	+\$447	+\$34
	INAGHL13.566-2F	66"	\$352	+\$173	\$0	+\$212	+\$212	+\$400	+\$0	+\$488	+\$488	+\$36
	INAGHL13.572-2F	72"	\$409	+\$199	\$0	+\$191	+\$191	+\$409	+\$0	+\$487	+\$487	+\$42
	INAGHL13.578-2F	78"	\$466	+\$229	\$0	+\$180	+\$180	+\$359	+\$0	+\$497	+\$497	+\$47
	INAGHL13.584-2F	84"	\$526	+\$258	\$0	+\$169	+\$169	+\$341	+\$0	+\$510	+\$510	+\$53
	INAGHL13.590-2F	90"	\$584	+\$288	\$0	+\$150	+\$150	+\$323	+\$0	+\$510	+\$510	+\$59
INAGHL13.596-2F	96"	\$644	+\$318	\$0	+\$138	+\$138	+\$302	+\$0	+\$521	+\$521	+\$65	

Description	Part number	List price
 <p>Add-On Glazing Top Cap Clip for 2 3/4" T Flat Trim Applications</p>	QCCLIPASSY-2F	\$6

System

Accessories



Wall Mounted

General information

- Wall mounted accessories may be specified to mount to any drywall application
- Additional wall bracing should be taken into consideration when ordering any wall hung component which will carry additional weight
- Ensure wall is adequately constructed and/or braced to ensure a secure installation
- All wall mount brackets are included

Notes

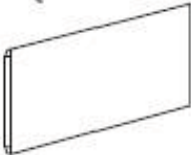
- **Only Expo Markers are to be used on any Inscape Whiteboard. Whiteboards should be cleaned with Expo Eraser or a Microfiber cleaning cloth along with Expo Cleaning Solution which is formulated to remove residue from Expo Dry Erase Markers**

Description	Part number	Height	Width	Weight (lbs)	List price
 13.5" H Wall Mount Whiteboard Tile	IN13.5WB30W	13.5"	30"	3	\$212
	IN13.5WB36W	13.5"	36"	4	\$217
	IN13.5WB42W	13.5"	42"	4	\$221
	IN13.5WB48W	13.5"	48"	5	\$224
	IN13.5WB54W	13.5"	54"	6	\$226
	IN13.5WB60W	13.5"	60"	6	\$230
 20.25" H Wall Mount Whiteboard Tile	IN20.25WB30W	20.25"	30"	5	\$221
	IN20.25WB36W	20.25"	36"	6	\$227
	IN20.25WB42W	20.25"	42"	7	\$232
	IN20.25WB48W	20.25"	48"	8	\$236
	IN20.25WB54W	20.25"	54"	9	\$239
	IN20.25WB60W	20.25"	60"	9	\$248
 23.6" H Wall Mount Whiteboard To be used above Planna cases	IN23.6WMWB24	23.6"	24"	4	\$227
	IN23.6WMWB30	23.6"	30"	5	\$235
	IN23.6WMWB36	23.6"	36"	6	\$243
	IN23.6WMWB42	23.6"	42"	7	\$249
	IN23.6WMWB48	23.6"	48"	8	\$252

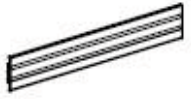
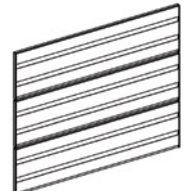
Description	Part number	Height	Width	Weight (lbs)	Neutral paint/ base price	Accent paint
 6.75" H Wall Mount Paper Management	IN6.75PM30W	6.75"	30"	5	\$186	+\$20
	IN6.75PM36W	6.75"	36"	6.5	\$200	+\$21
	IN6.75PM42W	6.75"	42"	8.5	\$221	+\$23
	IN6.75PM48W	6.75"	48"	9	\$236	+\$25
	IN6.75PM54W	6.75"	54"	11	\$253	+\$26
	IN6.75PM60W	6.75"	60"	12.5	\$269	+\$28
 20.25" H Wall Mount Paper Management	IN20.25PM24W	20.25"	24"	12	\$440	+\$45
	IN20.25PM30W	20.25"	30"	15	\$581	+\$59
	IN20.25PM36W	20.25"	36"	18	\$606	+\$61
	IN20.25PM42W	20.25"	42"	21	\$658	+\$66
	IN20.25PM48W	20.25"	48"	24	\$709	+\$72

General information

- Wall mounted accessories may be specified to mount to any drywall application
- Additional wall bracing should be taken into consideration when ordering any wall hung component which will carry additional weight
- Ensure wall is adequately constructed and/or braced to ensure a secure installation
- All wall mount brackets are included

Notes

- See finishes section for fabrics that require scrim

Description	Part number	Width	Weight (lbs)	Grade 1/COM	Grade 2	Grade 3	Grade 4	Grade 5	Grade 6	Grade 7	Grade 8	Scrim
	IN13.5TB18W	18"	2	\$220	+\$6	+\$11	+\$18	+\$24	+\$38	+\$52	+\$38	+\$20
	IN13.5TB24W	24"	3	\$227	+\$4	+\$9	+\$16	+\$22	+\$37	+\$51	+\$37	+\$22
	IN13.5TB30W	30"	3	\$248	+\$5	+\$9	+\$16	+\$22	+\$37	+\$52	+\$37	+\$23
	IN13.5TB36W	36"	4	\$253	+\$9	+\$22	+\$30	+\$37	+\$58	+\$79	+\$58	+\$24
	IN13.5TB42W	42"	4	\$261	+\$8	+\$23	+\$31	+\$39	+\$62	+\$84	+\$62	+\$26
	IN13.5TB48W	48"	5	\$268	+\$11	+\$23	+\$31	+\$39	+\$62	+\$85	+\$62	+\$27

13.5" H Wall Mount
Tackboard

	IN20.25TB18W	18"	3	\$252	+\$4	+\$10	+\$19	+\$28	+\$46	+\$65	+\$91	+\$22
	IN20.25TB24W	24"	4	\$272	+\$5	+\$16	+\$24	+\$32	+\$52	+\$73	+\$101	+\$24
	IN20.25TB30W	30"	5	\$281	+\$4	+\$17	+\$25	+\$33	+\$54	+\$75	+\$103	+\$26
	IN20.25TB36W	36"	6	\$287	+\$7	+\$18	+\$28	+\$37	+\$61	+\$85	+\$118	+\$28
	IN20.25TB42W	42"	7	\$296	+\$6	+\$12	+\$25	+\$37	+\$62	+\$87	+\$121	+\$30
	IN20.25TB48W	48"	8	\$302	+\$8	+\$24	+\$34	+\$44	+\$73	+\$99	+\$139	+\$32

20.25" H Wall Mount
Tackboard



	IN23.6WMTK24	24"	4	\$369	+\$5	+\$11	+\$22	+\$33	+\$58	+\$83	+\$116	+\$25
	IN23.6WMTK30	30"	5	\$382	+\$4	+\$12	+\$24	+\$36	+\$63	+\$90	+\$125	+\$27
	IN23.6WMTK36	36"	6	\$389	+\$8	+\$18	+\$30	+\$41	+\$73	+\$102	+\$143	+\$29
	IN23.6WMTK42	42"	7	\$401	+\$6	+\$12	+\$25	+\$38	+\$71	+\$102	+\$143	+\$31
	IN23.6WMTK48	48"	8	\$410	+\$9	+\$22	+\$34	+\$46	+\$81	+\$115	+\$161	+\$33

23.6" H Wall Mount
Tackboard
To be used above
Planna cases

General information

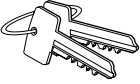
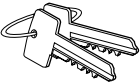
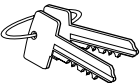

Notes

- **Only Expo Markers are to be used on any Inscape Whiteboard. Whiteboards should be cleaned with Expo Eraser or a Microfiber cleaning cloth along with Expo Cleaning Solution which is formulated to remove residue from Expo Dry Erase Markers**

Description	Part number	Height	Width	Weight (lbs)	List price
 19.5" H Magnetic Whiteboard	WHBDM137195	19.5"	14"	3	\$253
 33" H Magnetic Whiteboard	WHBDM13733	33"	14"	5	\$269
 Replacement Key Specify key number found on face of lock	RKEY	—	—	—	\$9
 Master Key Specify key number found on face of lock	MKEY	—	—	—	\$43
 Extractor Key Specify key number found on face of lock	EKEY	—	—	—	\$43

General information

- Overhead Storage sorters are to be ordered for use with overhead bin and shelves only
- No tools required to install components
- The sliding dividers are for use with Overhead Bin only

Description	Part number	Height	Width	Weight (lbs)	Neutral paint/ base price	Accent paint
 Bin-Mounted Sorter (pkg. of 3)	INLHSSB left-handed	—	—	9	\$181	+\$19
	INRHSSB right-handed (illustrated)	—	—	9	\$181	+\$19
 Shelf-Mounted Sorter (pkg. of 3)	INLHSSS left-handed	—	—	9	\$181	+\$19
	INRHSSS right-handed (illustrated)	—	—	9	\$181	+\$19
 Sliding Divider (qty of 3) Compatible with overhead bins	SDV	—	—	5	\$89	+\$10

System

Accessories

Electrified Twin-Bin

General information

- The Electrified Twin-Bin accessories are able to mount onto the back of the Electrified Twin-Bin only
- Do not specify these accessories with the standard Twin-Bin as they will interfere with the sliding door
- Electrified Twin-Bin Tackboard available in all grades of fabric
- Electrified Twin-Bin Shelf is only compatible with the Electrified Twin-Bin
- The width of the Electrified Twin-Bin accessories specified should be $\frac{1}{3}$ the overall width of the case (i.e. $36 \div 3 = 12$)

Notes

- **Only Expo Markers are to be used on any Inscape Whiteboard. Whiteboards should be cleaned with Expo Eraser or a Microfiber cleaning cloth along with Expo Cleaning Solution which is formulated to remove residue from Expo Dry Erase Markers**

Description	Part number	Height	Width	Weight (lbs)	Neutral paint/ base price	Accent paint
	Electrified Twin-Bin Shelf					
	INETWBSHF-12	—	12"	—	\$91	+\$10
	INETWBSHF-14	—	14"	—	\$91	+\$10
	INETWBSHF-16	—	16"	—	\$91	+\$10
	INETWBSHF-18	—	18"	—	\$91	+\$10
	INETWBSHF-20	—	20"	—	\$91	+\$10

Description	Part number	Height	Width	Weight (lbs)	Neutral paint/ base price	Accent paint
	Electrified Twin-Bin Whiteboard					
	INTWBWB-12	14"	12"	—	\$33	—
	INTWBWB-14	14"	14"	—	\$33	—
	INTWBWB-16	14"	16"	—	\$33	—
	INTWBWB-18	14"	18"	—	\$37	—
	INTWBWB-20	14"	20"	—	\$37	—

Description	Part number	Height	Width	Weight (lbs)	Grade 1/ COM	Grade 2	Grade 3	Grade 4	Grade 5	Grade 6	Grade 7	Grade 8
	INTWBTB-12	14"	12"	—	\$112	+\$5	+\$12	—	+\$24	—	+\$64	—
	INTWBTB-14	14"	14"	—	\$115	+\$5	+\$12	—	+\$24	—	+\$64	—
	INTWBTB-16	14"	16"	—	\$120	+\$5	+\$12	—	+\$24	—	+\$64	—
	INTWBTB-18	14"	18"	—	\$126	+\$5	+\$12	—	+\$24	—	+\$64	—
	INTWBTB-20	14"	20"	—	\$137	+\$5	+\$12	—	+\$24	—	+\$64	—

Electrified Twin-Bin Tackboard

General information

- “2F” denotes use with 2 ¾” thick frame
“3F” denotes use with 3 ½” thick frame
- Shared Twin Bin Top span the frame to give one complete finished top (no top trim required to be specified in this location)
- Single Twin Bin and Shared Twin Bin Tops are specified for the top of the Twin Bin
- Two Single Twin Bin Tops are required to finish one Twin Bin as there are two sides (either side of frame)
- Twin Bin tops are shipped complete with ability to mount directly on case
- Nuform and Veneer Twin Bin Tops are ¾” thick



Notes

In order to get a total cost on products when upcharges are present take the list price of the product number and add the upcharge cost shown to the list price.

For example:

Product INTWBTOP36-3F 0.25” in veneer would be \$242 +\$458

Description	Part number	Height	Width	Weight (lbs)	Neutral paint/ base price	Accent paint
	Shared Twin Bin Top, painted					
	INTWST-30	—	30”	—	\$278	+\$29
	INTWST-36	—	36”	—	\$337	+\$35
	INTWST-42	—	42”	—	\$351	+\$36
	INTWST-48	—	48”	—	\$385	+\$39
	INTWST-54	—	54”	—	\$419	+\$43
	INTWST-60	—	60”	—	\$451	+\$46

Description	Part number	Depth	Width	Weight (lbs)	Nuform solid	Nuform woodgrain/ pattern	Veneer
	Single Twin Bin Top						
	For use with 3 ½” T frames						
	Required 2 per bin						
		INTWBTOP36-3F	5”	36”	2	\$242	+\$26
	INTWBTOP42-3F	5”	42”	2	\$251	+\$27	+\$496
	INTWBTOP48-3F	5”	48”	2	\$276	+\$29	+\$524
	INTWBTOP60-3F	5”	60”	3	\$323	+\$29	+\$529
	Single Twin Bin Top						
	For use with 2 ¾” T frames						
	Required 2 per bin						
		INTWBTOP36-2F	5.4”	36”	2	\$242	+\$26
	INTWBTOP42-2F	5.4”	42”	2	\$251	+\$27	+\$496
	INTWBTOP48-2F	5.4”	48”	2	\$276	+\$29	+\$524
	INTWBTOP60-2F	5.4”	60”	3	\$323	+\$29	+\$529



System

Accessories





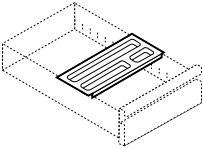
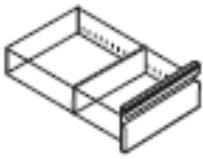
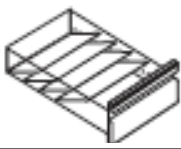
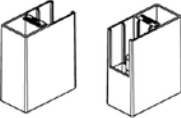



Pedestal

General information

- Pedestal Extended leveling glide consists of a 1.5" stem

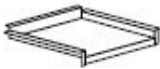
Description	Part number	Height	Width	Weight (lbs)	List price
 <p>Pencil tray for letter width box drawer Black plastic</p>	PFWS-PT15 Letter Width	—	15"	1	\$31
	PFWS-PT18 Legal Width	—	18"	1	\$32
 <p>Divider for box drawer</p>	PFWS-DV15 Letter Width	—	15"	0.5	\$17
	PFWS-DV18 Legal Width	—	18"	0.5	\$18
 <p>Set of 4 modular sloped stationery dividers fits box drawer letter width pedestal</p>	PFMD-SO15 Letter Width	—	15"	1	\$64
	PFMD-SO18 Legal Width	—	18"	1	\$67
 <p>Rectangular Pedestal Glides, Gray Set of 4</p>	LV019	—	—	—	\$38
 <p>1.5" stem leveling glides Set of 4</p>	LG	3 1/2"	—	1	\$24
 <p>Platform leveling glide for lateral files (set of 4). 3 1/2" diameter x 1 1/2" high plastic 'shoe'. 1 3/8" leveling adjustment</p>	PLG-L3	—	—	—	\$26
	PLG-L3-GRY	—	—	—	\$26

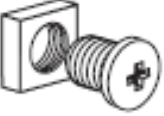
General information

Description	Part number	Height	Width	Weight (lbs)	List price	Accent paint
 Plate divider for 3" and 4.5" shelves/drawers	PFDVP-3	—	—	0.5	\$13	—
 Plate divider for 6", 7.5" and 9" shelves/drawers	PFDVP6-9	—	—	0.75	\$13	—
 Plate divider for 10.5", 12", 13.5", 15" and 16.5" drawers or slotted shelves	PFDVP	—	—	1	\$13	—
 Slotted Shelf Fixed slotted shelf installs behind 12", 13.5", 15" and 16.5" lift-up door or in hinged door cabinet. Shelf is adjustable on a 1.5" increment.	PFSH-30	—	30"	11	\$87	+\$10
	PFSH-36	—	36"	12	\$87	+\$10
	PFSH-42	—	42"	13	\$87	+\$10
 Adjustable non-slotted shelf 15" deep	BKSH-3015	0.5"	30"	11	\$87	+\$10
	BKSH-3615	0.5"	36"	11	\$87	+\$10
	BKSH-4215	0.5"	42"	11	\$87	+\$10
 Adjustable shelf for split base units 15" deep	SWSH-15	0.5"	15"	4	\$76	+\$9
 Standard Paper Related Accessories Hangfile bars for 10.5", 12", 13.5", 15" and 16.5" pullout shelves/drawers set of 2	PFHF-30	—	30"	2	\$37	—
	PFHF-36	—	36"	3	\$37	—
	PFHF-42	—	42"	4	\$37	—
 Sliding rails used in conjunction with HF bars for front-to-back filing, sold individually	PFSR	—	1.1875"	1	\$12	—
 Ganging Kit	PFGK	—	—	—	\$11	—
 18" mobile support frame, for 30" and 36" wide lateral files with maximum of three pullout drawers and maximum interior height of 43.5" Note: Counterweight must be installed in lateral file	PFMFK18	4 5/8"	—	10	\$470	—



System



Accessories

Lateral

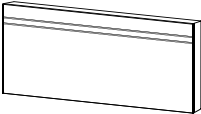
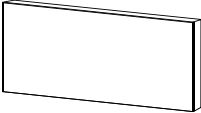
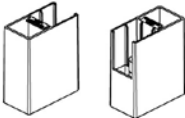
General information

- Counterweight recommended for all freestanding lateral file cabinets
- Counterweight secure with 2-way tape
- Lateral Extended leveling glide consists of a 1.5" stem
- Nuform and Veneer lateral tops are 3/8" thick
- Lateral tops are not available with plywood edge band

Description	Part number	Height	Width	Weight (lbs)	List price
 <p>24" mobile support frame, for 24" and 30" wide Workplace Towers with maximum of three pullout drawers and maximum height of 58 3/4" Note: Counterweight is recommended</p>	PFMFK24	4 5/8"	24"	11	\$470
 <p>Counterweight, recommended for all freestanding lateral file cabinets with 22.5" interior dimension or higher</p>	IMCW-30	—	30"	38	\$125
	IMCW-36	—	36"	38	\$125
	IMCW-42	—	42"	52	\$125
 <p>Counterweight, recommended for all freestanding lateral file cabinets with less than 22.5" interior dimension</p>	CW	—	—	48	\$125
 <p>Rectangular Lateral Glides, Gray Set of 4</p>	LV018	—	—	—	\$38
 <p>1.5" stem leveling glides Set of 4</p>	LG	3 1/2"	—	1	\$24
 <p>Platform leveling glide for lateral files (set of 4). 3 1/2" diameter x 1 1/2" high plastic 'shoe'. 1 3/8" leveling adjustment</p>	PLG-L3	—	—	—	\$26
	PLG-L3-GRY	—	—	—	\$26

Description	Part number	Width	Depth	Nuform solid/laminate	Nuform woodgrain/pattern	Grade 1 laminate	Veneer
 <p>15" D x 3/8" T Lateral Top</p>	INSWTOP1530	30"	15"	\$176	+\$13	+\$57	+\$297
	INSWTOP1536	36"	15"	\$190	+\$27	+\$61	+\$336
	INSWTOP1542	42"	15"	\$215	+\$30	+\$69	+\$368
	INSWTOP1548	48"	15"	\$239	+\$35	+\$77	+\$395
	INSWTOP1554	54"	15"	\$263	+\$40	+\$85	+\$418
	INSWTOP1560	60"	15"	\$325	+\$92	+\$104	+\$473
	INSWTOP1572	72"	15"	\$353	+\$109	+\$113	+\$493
INSWTOP1578	78"	15"	\$384	+\$99	+\$123	+\$522	
 <p>18" D x 3/8" T Lateral Top</p>	INSWTOP1830	30"	18"	\$192	+\$11	+\$62	+\$333
	INSWTOP1836	36"	18"	\$206	+\$30	+\$66	+\$379
	INSWTOP1842	42"	18"	\$232	+\$37	+\$75	+\$413
	INSWTOP1848	48"	18"	\$257	+\$44	+\$83	+\$449
	INSWTOP1854	54"	18"	\$285	+\$45	+\$92	+\$489
	INSWTOP1860	60"	18"	\$441	+\$47	+\$142	+\$846
	INSWTOP1872	72"	18"	\$527	+\$54	+\$169	+\$860
INSWTOP1878	78"	18"	\$613	+\$63	+\$197	+\$836	

General information

- Includes stand offs to mount on back of case in the field
- Available in White only, colors as special

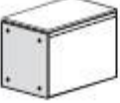
Description	Part number	Height	Width	Weight (lbs)	List price
	Lateral Back Painted Glass				
	PLN30LBPB	24"	30"	16	\$696
	PLN36LBPB	24"	36"	19	\$771
	PLN42LBPB	24"	42"	22	\$847
	Pedestal Back Painted Glass				
	PLN15LBPB	24"	15"	16	\$547

General information

- SuperStor inserts for use with Storwal and laterals
- 30" w SuperStor insert accepts 12 Standard Trays and 3 Small Trays
- 36" w SuperStor insert accepts 18 Standard Trays
- 42" w SuperStor insert accepts 18 Standard Trays and 3 Small Trays
- Insert and trays may be painted in Inscape System standard color options

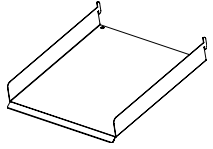
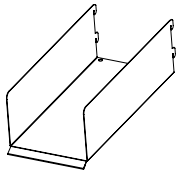
Description	Part number	Height	Width	Weight (lbs)	List price	Accent paint
	SuperStor Inserts					
	INSW13.5SS-30	13.5"	30"	10	\$93	+\$11
	INSW13.5SS-36	13.5"	36"	12	\$109	+\$12
	INSW13.5SS-42	13.5"	42"	14	\$123	+\$14
	Standard SuperStor Trays (pkg. of 6)	—	—	6	\$212	+\$22
	Small SuperStor Trays (pkg. of 3)	—	—	3	\$109	+\$12

General information

- Cushions may be installed on any storage case
- Velcro is included with the cushion for adhesion on the case
- Cushions are 1.25" thick and are to be specified with using only approved Upholstery standards from Inscape or COM
- If optioning a cushion on a Planna case, remove Planna rail

Notes

In order to get a total cost on products when upcharges are present take the list price of the product number and add the upcharge cost shown to the list price.

For example:

Product CSH15X18X125 in Grade C fabric would be \$238 +\$89

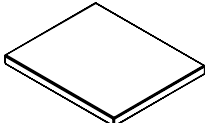
Description	Part number	Height	Width	Depth	Weight (lbs)	Grade A	Grade B/ COM	Grade C	Grade D	Grade E	Grade F
	CSH15X18X125	1 ¼"	15"	18"	5	\$238	+\$48	+\$89	+\$126	+\$151	+\$216
	CSH15X22X125	1 ¼"	15"	22"	6	\$244	+\$48	+\$89	+\$126	+\$151	+\$216
	CSH15X28X125	1 ¼"	15"	28"	13	\$253	+\$48	+\$89	+\$126	+\$151	+\$216

15"W Pedestal
Cushion
(Planna, 7900
Series, Radius, Grid
pedestals)

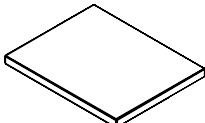
	CSH15X18.75X125	1 ¼"	15"	18 ¾"	8	\$239	+\$48	+\$89	+\$126	+\$151	+\$216
	CSH15X22.75X125	1 ¼"	15"	22 ¾"	9	\$245	+\$48	+\$89	+\$126	+\$151	+\$216
	CSH15X28.75X125	1 ¼"	15"	28 ¾"	13	\$254	+\$48	+\$89	+\$126	+\$151	+\$216

15"w Pedestal
Cushion
(9900 Series,
Storage Center)

	CSH15X36X125	1 ¼"	15"	36"	15	\$273	+\$48	+\$89	+\$126	+\$151	+\$216
---	---------------------	------	-----	-----	----	-------	-------	-------	--------	--------	--------

36" d Pedestal
Cushion
(for back to back
Planna, 7900
Series, Radius, Grid
pedestal application)

System

Accessories

Cushions

General information



- Cushions may be installed on any storage case
- Velcro is included with the cushion for adhesion on the case
- Cushions are 1.25" thick and are to be specified with using only approved Upholstery standards from Inscope or COM
- If optioning a cushion on a Planna case, remove Planna rail

Notes

In order to get a total cost on products when upcharges are present take the list price of the product number and add the upcharge cost shown to the list price.

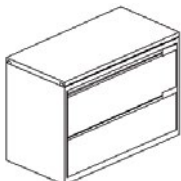
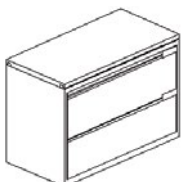

For example:

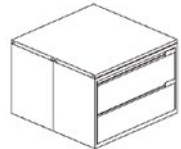
Product LATCUSH1830SL in Grade C fabric would be \$369 +\$142

Description	Part number	Height	Width	Depth	Weight (lbs)	Grade A	Grade B/ COM	Grade C	Grade D	Grade E	Grade F
 18" d Lateral Cushion (standard application)	LATCUSH1830SL	1 ¼"	30"	18"	7	\$369	+\$71	+\$142	+\$172	+\$214	+\$316
	LATCUSH1836SL	1 ¼"	36"	18"	8	\$401	+\$83	+\$166	+\$201	+\$249	+\$369
	LATCUSH1842SL	1 ¼"	42"	18"	10	\$435	+\$95	+\$131	+\$232	+\$286	+\$422
	LATCUSH1860SL	1 ¼"	60"	18"	14	\$527	+\$151	+\$280	+\$375	+\$451	+\$645
	LATCUSH1866SL	1 ¼"	66"	18"	15	\$573	+\$144	+\$234	+\$350	+\$431	+\$634
	LATCUSH1872SL	1 ¼"	72"	18"	15	\$621	+\$155	+\$307	+\$379	+\$465	+\$686
	LATCUSH1878SL	1 ¼"	78"	18"	17	\$770	+\$180	+\$355	+\$439	+\$539	+\$792
	LATCUSH1884SL	1 ¼"	84"	18"	24	\$680	+\$180	+\$355	+\$439	+\$539	+\$792
 19 ¾" d Lateral Cushion (Benching application with electrical)	LATCUSH19830SL	1 ¼"	30"	19 ¾"	7	\$378	+\$71	+\$141	+\$172	+\$213	+\$315
	LATCUSH19836SL	1 ¼"	36"	19 ¾"	8	\$414	+\$82	+\$165	+\$200	+\$248	+\$368
	LATCUSH19842SL	1 ¼"	42"	19 ¾"	10	\$449	+\$94	+\$188	+\$231	+\$285	+\$518
	LATCUSH19860SL	1 ¼"	60"	19 ¾"	14	\$558	+\$130	+\$259	+\$319	+\$393	+\$579
	LATCUSH19866SL	1 ¼"	66"	19 ¾"	15	\$594	+\$143	+\$283	+\$348	+\$430	+\$632
	LATCUSH19872SL	1 ¼"	72"	19 ¾"	15	\$629	+\$125	+\$306	+\$378	+\$465	+\$685
	LATCUSH19878SL	1 ¼"	78"	19 ¾"	17	\$666	+\$117	+\$330	+\$406	+\$501	+\$737
	LATCUSH19884SL	1 ¼"	84"	19 ¾"	24	\$702	+\$179	+\$354	+\$437	+\$537	+\$790
 21 ½" d Lateral Cushion (Private Office application with electrical)	LATCUSH21530SL	1 ¼"	30"	21 ½"	7	\$378	+\$76	+\$147	+\$177	+\$218	+\$320
	LATCUSH21536SL	1 ¼"	36"	21 ½"	8	\$420	+\$82	+\$165	+\$200	+\$248	+\$368
	LATCUSH21542SL	1 ¼"	42"	21 ½"	11	\$451	+\$94	+\$188	+\$230	+\$285	+\$421
	LATCUSH21560SL	1 ¼"	60"	21 ½"	15	\$574	+\$130	+\$258	+\$318	+\$392	+\$578
	LATCUSH21566SL	1 ¼"	66"	21 ½"	16	\$611	+\$142	+\$283	+\$347	+\$428	+\$631
	LATCUSH21572SL	1 ¼"	72"	21 ½"	17	\$649	+\$154	+\$306	+\$377	+\$463	+\$684
	LATCUSH21578SL	1 ¼"	78"	21 ½"	18	\$661	+\$333	+\$333	+\$476	+\$573	+\$818
	LATCUSH21584SL	1 ¼"	84"	21 ½"	19	\$691	+\$205	+\$380	+\$508	+\$613	+\$875
 36" d Lateral Cushion (back-to-back application)	LATCUSH3630SL	1 ¼"	30"	36"	14	\$456	+\$67	+\$139	+\$166	+\$207	+\$309
	LATCUSH3636SL	1 ¼"	36"	36"	19	\$502	+\$79	+\$162	+\$194	+\$242	+\$361
	LATCUSH3642SL	1 ¼"	42"	36"	19	\$530	+\$91	+\$185	+\$225	+\$279	+\$414
 39 ½" d Lateral Cushion (Back-to-back benching application with electrical)	LATCUSH39530SL	1 ¼"	30"	39 ½"	14	\$463	+\$67	+\$138	+\$165	+\$206	+\$308
	LATCUSH39536SL	1 ¼"	36"	39 ½"	19	\$505	+\$116	+\$184	+\$218	+\$266	+\$388
	LATCUSH39542SL	1 ¼"	42"	39 ½"	19	\$575	+\$91	+\$185	+\$232	+\$277	+\$413

General information

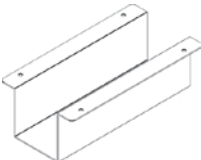
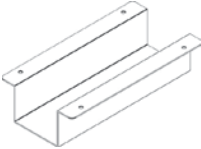
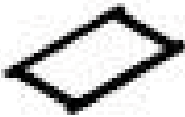
- Planna Storage Support Brackets are shipped as a pair and are both required per Planna Storage worksurface installation
- Hat Channel heights are nominal and they support a standard worksurface height of 28.5"
- Planna Storage rail kits are optional on Planna Storage cases, DO NOT specify if a cushion is to be installed
- Lateral kits install with the rail running the width of the case (side to side)
- Pedestal kits install with the rail running the depth of the case (front to back) EXCEPT for the 18"d which runs side to side
- Planna Storage rails are only available in silver (match to P290 Aluminum Leaf)
- Planna Storage Rail kits include mounting hardware to adhere to the case if ordered separate from Planna Storage case

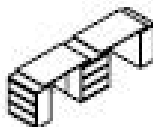
Description	Part number	Width	Depth	Weight (lbs)	List price	Accent paint
 Planna Bracket (pair) Adjustable Height	PSUPBKT	—	—	1	\$79	+\$9
 9" W x 2.89"H Hat Channel For use over Planna case with ½" top with no rail	HATCHNL2.89	2.89"	2	—	\$44	+\$6
 9" W x 2.375"H Hat Channel For use over Planna case with ½" top and ½" rail	HATCHNL2.3759	2.375"	2	—	\$44	+\$6
 Lateral Rail Kit (rails run case width)	PLANNA-KIT30	30"	18"	5	\$139	—
	PLANNA-KIT36	36"	18"	6	\$143	—
	PLANNA-KIT42	42"	18"	6	\$148	—
 Pedestal Rail Kit (rails run case depth)	PLANNA-KIT1518	15"	15"	3	\$134	—
	PLANNA-KIT1522	15"	22"	4	\$139	—
	PLANNA-KIT1528	15"	28"	5	\$143	—
 Rail Kit for collaborative Area (rails run depth of back-to-back cases)	PLANNA-KIT3615	36"	15"	5	\$163	—
	PLANNA-KIT3621	36"	21"	5	\$180	—

System

Accessories

Planna Storage

Pedestals and Lateral Tops

General information



- Planna Storage tops are ½" thick to withstand weight that may be placed on the Planna Storage case
- Various depths and widths have been created for multiple configurations. Refer to drawing in left column for details
- Planna Storage tops are shipped with double sided tape to adhere on the Planna Storage rails

Notes

In order to get a total cost on products when upcharges are present take the list price of the product number and add the upcharge cost shown to the list price.

For example:

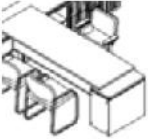
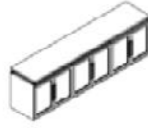
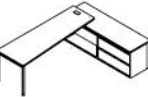
Product PLN1518 in Nuform woodgrain would be \$73 +\$13

Description	Part number	Width	Depth	Weight (lbs)	Nuform solid	Nuform woodgrain/pattern	Veneer
 Pedestal Top	PLN1518	15"	18"	4	\$73	+\$13	+\$397
	PLN1522	15"	22"	5	\$96	+\$13	+\$402
	PLN1528	15"	28"	6	\$119	+\$13	+\$409
 Single Depth Lateral Top	PLN1830	30"	18"	7	\$127	+\$16	+\$417
	PLN1836	36"	18"	8	\$147	+\$18	+\$415
	PLN1842	42"	18"	10	\$167	+\$19	+\$455
	PLN1845	45"	18"	11	\$182	+\$22	+\$501
	PLN1851	51"	18"	12	\$195	+\$24	+\$546
	PLN1857	57"	18"	13	\$212	+\$26	+\$591
	PLN1860	60"	18"	14	\$224	+\$27	+\$637
	PLN1866	66"	18"	16	\$245	+\$27	+\$675
	PLN1872	72"	18"	17	\$264	+\$31	+\$717
	PLN1878	78"	18"	18	\$284	+\$32	+\$766
	PLN1884	84"	18"	20	\$302	+\$37	+\$817
	PLN1890	90"	18"	21	\$324	+\$35	+\$864
PLN1896	96"	18"	23	\$338	+\$42	+\$921	
 21 ½" D Lateral Top	PLNP2130	30"	21 ½"	7	\$142	+\$17	+\$422
	PLNP2136	36"	21 ½"	8	\$162	+\$19	+\$420
	PLNP2142	42"	21 ½"	11	\$184	+\$21	+\$456
	PLNP2145	45"	21 ½"	11	\$198	+\$23	+\$501
	PLNP2151	51"	21 ½"	13	\$216	+\$25	+\$545
	PLNP2157	57"	21 ½"	15	\$230	+\$27	+\$589
	PLNP2160	60"	21 ½"	15	\$247	+\$29	+\$632
	PLNP2166	66"	21 ½"	16	\$270	+\$32	+\$669
	PLNP2172	72"	21 ½"	18	\$290	+\$43	+\$712
	PLNP2178	78"	21 ½"	19	\$311	+\$34	+\$761
	PLNP2184	84"	21 ½"	21	\$331	+\$40	+\$811
	PLNP2190	90"	21 ½"	23	\$355	+\$52	+\$858
PLNP2196	96"	21 ½"	24	\$389	+\$58	+\$894	
 Back to Back Depth Lateral Top	PLN3630	30"	36"	14	\$217	+\$33	—
	PLN3636	36"	36"	17	\$247	+\$40	—
	PLN3642	42"	36"	20	\$278	+\$46	—
	PLN3645	45"	36"	22	\$305	+\$50	—
	PLN3651	51"	36"	25	\$327	+\$55	—
	PLN3657	57"	36"	27	\$349	+\$60	—
	PLN3660	60"	36"	28	\$371	+\$65	—
	PLN3666	66"	36"	31	\$390	+\$65	—
	PLN3672	72"	36"	34	\$431	+\$79	—
	PLN3678	78"	36"	37	\$452	+\$78	—
	PLN3684	84"	36"	39	\$493	+\$91	—
	PLN3690	90"	36"	42	\$515	+\$91	—
PLN3696	96"	36"	45	\$554	+\$104	—	

General information



- Planna Storage tops are ½" thick to withstand weight that may be placed on the Planna Storage case
- Various depths and widths have been created for multiple configurations. Refer to drawing in left column for details
- Planna Storage tops are shipped with double sided tape to adhere on the Planna Storage rails

Notes

In order to get a total cost on products when upcharges are present take the list price of the product number and add the upcharge cost shown to the list price.

For example:

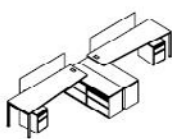
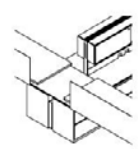
Product PLNB1930 in Nuform woodgrain would be \$127 +\$16

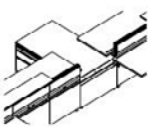
Description	Part number	Height	Width	Weight (lbs)	Nuform solid	Nuform woodgrain/pattern	Veneer	
	Single Depth Lateral Top with 1 ¾" D Overhang	PLNB1930	30"	19 ¾"	6	\$127	+\$16	—
	PLNB1936	36"	19 ¾"	7	\$147	+\$18	—	
	PLNB1942	42"	19 ¾"	8	\$167	+\$19	—	
	PLNB1945	45"	19 ¾"	9	\$184	+\$21	—	
	PLNB1951	51"	19 ¾"	10	\$199	+\$22	—	
	PLNB1957	57"	19 ¾"	11	\$218	+\$23	—	
	PLNB1960	60"	19 ¾"	11	\$224	+\$27	—	
	PLNB1972	72"	19 ¾"	14	\$264	+\$31	—	
	PLNB1984	84"	19 ¾"	14	\$302	+\$37	—	
	Double Depth Back to Back with 3 ½" Additional Depth	PLNB3930	30"	39 ½"	12	\$217	+\$33	—
	PLNB3936	36"	39 ½"	14	\$247	+\$40	—	
	PLNB3942	42"	39 ½"	16	\$278	+\$46	—	
	PLNB3945	45"	39 ½"	17	\$305	+\$50	—	
	PLNB3951	51"	39 ½"	20	\$335	+\$55	—	
	PLNB3957	57"	39 ½"	22	\$371	+\$65	—	
	Single Depth Lateral Top with 1 ¾" Additional Overhang ½" thick	PLNB1831	31 ¾"	18"	6	\$127	+\$16	—
	PLNB1837	37 ¾"	18"	7	\$147	+\$18	—	
	PLNB1843	43 ¾"	18"	8	\$167	+\$19	—	
	PLNB1846	46 ¾"	18"	8	\$184	+\$21	—	
	PLNB1852	52 ¾"	18"	9	\$199	+\$22	—	
	PLNB1858	58 ¾"	18"	9	\$218	+\$23	—	
	PLNB1861	61 ¾"	18"	11	\$224	+\$27	—	
	PLNB1873	73 ¾"	18"	13	\$264	+\$31	—	
	PLNB1885	85 ¾"	18"	15	\$302	+\$37	—	
	Double Depth Lateral Top with 1 ¾" Length Overhang	PLNB3631	31 ¾"	36"	11	\$217	+\$33	—
	PLNB3637	37 ¾"	36"	13	\$247	+\$40	—	
	PLNB3643	43 ¾"	36"	15	\$278	+\$46	—	
	PLNB3646	46 ¾"	36"	16	\$305	+\$50	—	
	PLNB3652	52 ¾"	36"	18	\$326	+\$50	—	
	PLNB3658	58 ¾"	36"	20	\$340	+\$50	—	
	PLNB3661	61 ¾"	36"	22	\$371	+\$65	—	
	PLNB3667	67 ¾"	36"	24	\$390	+\$65	—	
	PLNB3673	73 ¾"	36"	26	\$431	+\$79	—	
	PLNB3679	79 ¾"	36"	28	\$452	+\$78	—	
	PLNB3685	85 ¾"	36"	30	\$493	+\$91	—	
	PLNB3691	91 ¾"	36"	32	\$515	+\$91	—	
	PLNB3697	97 ¾"	36"	34	\$554	+\$104	—	

System

Accessories

Storwal Storage

Worksurfaces Support Bracket

General information

- Storwal Worksurface Support Bracket are shipped as a pair and both are to require per Storwal worksurface applications
- Brackets may be optioned in any of Inscape Systems standard paint colors
- Adjustable bracket adjusts vertically to match the Inscape Standard 5 worksurface heights: 25.5", 27", 28.5", 30", and 31.5"

Description	Part number	Height	Width	Weight (lbs)	Natural paint/ base price	Accent paint	
	Storwal Bracket (pair)	INSWSUPBT-28.5 Fixed Height	1 ¼"	—	1	\$66	+\$8
		INSWSUPBT-ADJ Adjustable Height	1 ¼"	—	1	\$114	+\$13

General information

- Storwal tackboards may not be specified adjacent to a sliding door
- Attachment hardware to attach to Storwal is included with the tackboard
- Standard panel fabric or COM may be specified on the tackboard
- Fabric applied in a railroad orientation
- See finishes section for fabrics that require scrim

Notes

In order to get a total cost on products when upcharges are present take the list price of the product number and add the upcharge cost shown to the list price.

For example:

Product SW13.5TC-30 in Grade 5 fabric would be \$477 +\$20

Description	Part number	Height	Width	Weight (lbs)	Grade 1/ COM	Grade 2	Grade 3	Grade 4	Grade 5	Grade 6	Grade 7	Grade 8
	SW13.5TC-30	13 1/2"	30"	1	\$477	+\$5	—	—	+\$20	—	+\$27	—
	SW13.5TC-36	13 1/2"	36"	1	\$490	+\$8	—	—	+\$29	—	+\$121	—
	SW13.5TC-42	13 1/2"	42"	1	\$498	+\$7	—	—	+\$47	—	+\$144	—

Tackboard for 16 3/8" H Stack Units



SW27TC-30	27"	30"	2	\$553	+\$5	—	—	+\$43	—	+\$138	—
SW27TC-36	27"	36"	2	\$580	+\$7	—	—	+\$47	—	+\$154	—
SW27TC-42	27"	42"	3	\$594	+\$6	—	—	+\$44	—	+\$152	—

Tackboard for 29 7/8" H Stack Units



SW33TC-30	33"	30"	2	\$656	+\$6	—	—	+\$44	—	+\$142	—
SW33TC-36	33"	36"	2	\$711	+\$8	—	—	+\$48	—	+\$169	—
SW33TC-42	33"	42"	3	\$750	+\$7	—	—	+\$46	—	+\$160	—

Tackboard for 38 7/8" H Stack Units

System

Accessories

Storwal Storage



Whiteboards Not Adjacent to Sliding Doors

General information

- This whiteboard is only to be specified when it is NOT being installed adjacent to a Storwal Sliding Door
- Mounting hardware is included with this kit

Notes

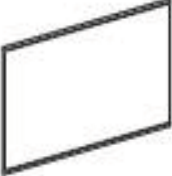
- **Only Expo Markers are to be used on any Inscape Whiteboard. Whiteboards should be cleaned with Expo Eraser or a Microfiber cleaning cloth along with Expo Cleaning Solution which is formulated to remove residue from Expo Dry Erase Markers**



Description	Part number	Height	Width	Weight (lbs)	List price	
	Whiteboard for 16 $\frac{3}{8}$ " H	SW13.5WB-30	13 $\frac{1}{2}$ "	30"	6	\$156
	Stack Units	SW13.5WB-36	13 $\frac{1}{2}$ "	36"	7	\$176
	(not adjacent to sliding door)	SW13.5WB-42	13 $\frac{1}{2}$ "	42"	8	\$199
	Whiteboard for 29 $\frac{7}{8}$ " H	SW27WB-30	27"	30"	11	\$202
	Stack Units	SW27WB-36	27"	36"	14	\$225
	(not adjacent to sliding door)	SW27WB-42	27"	42"	16	\$255
	Whiteboard for 38 $\frac{7}{8}$ " H	SW33WB-30	33"	30"	14	\$211
	Stack Units	SW33WB-36	33"	36"	17	\$231
	(not adjacent to sliding door)	SW33WB-42	33"	42"	19	\$261

General information

- This Whiteboard is only to be specified when a Storwal Sliding Door is being installed directly adjacent to the Whiteboard – this is due to the Sliding Door having the mounting hardware for the whiteboard
- Mounting hardware is included with this kit

Notes

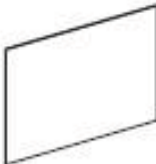
- **Only Expo Markers are to be used on any Inscape Whiteboard. Whiteboards should be cleaned with Expo Eraser or a Microfiber cleaning cloth along with Expo Cleaning Solution which is formulated to remove residue from Expo Dry Erase Markers**

Description	Part number	Height	Width	Weight (lbs)	List price
 Whiteboard for 16 $\frac{3}{8}$ " H Stack Units (adjacent to sliding door)	SW13.5WBS-30	13 $\frac{1}{2}$ "	30"	6	\$48
	SW13.5WBS-36	13 $\frac{1}{2}$ "	36"	7	\$52
	SW13.5WBS-42	13 $\frac{1}{2}$ "	42"	8	\$56
 Whiteboard for 29 $\frac{7}{8}$ " H Stack Units (adjacent to sliding door)	SW27WBS-30	27"	30"	11	\$96
	SW27WBS-36	27"	36"	14	\$102
	SW27WBS-42	27"	42"	16	\$112
 Whiteboard for 38 $\frac{7}{8}$ " H Stack Units (adjacent to sliding door)	SW33WBS-30	33"	30"	14	\$102
	SW33WBS-36	33"	36"	17	\$109
	SW33WBS-42	33"	42"	19	\$118

System

Accessories

Storage



Back Painted Glass Whiteboards

General information







- All mounting hardware is included with the whiteboard kit to mount to a Storwal case
- White back paint only
- Sliding doors cannot be installed adjacent to Back Painted Glass whiteboards

Notes

- **Only Expo Markers are to be used on any Inscape Whiteboard. Whiteboards should be cleaned with Expo Eraser or a Microfiber cleaning cloth along with Expo Cleaning Solution which is formulated to remove residue from Expo Dry Erase Markers**

Description	Part number	Height	Width	Weight (lbs)	List price	
	Back Painted Glass Whiteboard for 16 $\frac{3}{8}$ " H Stack Units	SW13.5BPGWB-30	13 $\frac{1}{2}$ "	30"	5	\$504
		SW13.5BPGWB-36	13 $\frac{1}{2}$ "	36"	6	\$594
		SW13.5BPGWB-42	13 $\frac{1}{2}$ "	42"	7	\$683
	Back Painted Glass Whiteboard for 29 $\frac{7}{8}$ " H Stack Units	SW27BPGWB-30	27"	30"	9	\$769
		SW27BPGWB-36	27"	36"	10	\$911
		SW27BPGWB-42	27"	42"	12	\$1052
	Back Painted Glass Whiteboard for 38 $\frac{7}{8}$ " H Stack Units	SW33BPGWB-30	33"	30"	11	\$902
		SW33BPGWB-36	33"	36"	12	\$1070
		SW33BPGWB-42	33"	42"	14	\$1237

General information

Description	Part number	Height	Width	Weight (lbs)	List price	Accent paint	
	Adjustable Shelf for Hinged Door Cabinets	SWSvH-30	—	30"	11	\$85	+\$10
		SWSH-36	—	36"	12	\$85	+\$10
		SWSH-42	—	42"	13	\$85	+\$10
	Adjustable Shelf for Bookcases and Tambour Door Cabinets	SWBKSH-30	—	30"	12	\$85	+\$10
		SWBKSH-36	—	36"	13	\$85	+\$10
		SWBKSH-42	—	42"	14	\$85	+\$10
	Adjustable shelf for split base units 15" deep	SWSH-15	0.5"	15"	4	\$76	+\$9
	Hang File Bar for Lateral File Unit set of 2	SWHF-30	—	30"	2	\$35	—
		SWHF-36	—	36"	3	\$35	—
		SWHF-42	—	42"	4	\$35	—
	Hang File Bar for Split Unit set of 2	SWHF-36SPLIT	—	21"	3	\$35	—
		SWHF-42SPLIT	—	27"	4	\$35	—
	Sliding rails used in conjunction with HF bars for front-to-back filing, sold individually	SWSR	—	—	1	\$12	—





System

Accessories

Storwal Storage
Case Accessories

General information

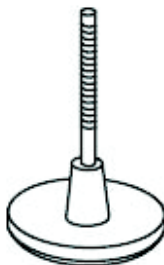
- SuperStor inserts for use with Storwal and laterals
- 30" w SuperStor insert accepts 12 Standard Trays and 3 Small Trays
- 36" w SuperStor insert accepts 18 Standard Trays
- 42" w SuperStor insert accepts 18 Standard Trays and 3 Small Trays
- Insert and trays may be painted in Inscape System standard color options

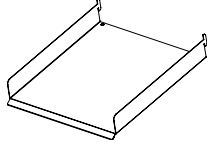
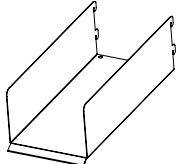
Description	Part number	Height	Width	Weight (lbs)	List price	Accent paint
 Storwal Electrical Module Side Cover	ECOVER	—	18"	1	\$32	+\$5
 Storwal Electrical Module Front Cover with Cutouts	EFRCOVER-30	—	30"	—	\$50	+\$6
	EFRCOVER-36	—	36"	—	\$50	+\$6
	EFRCOVER-42	—	42"	—	\$50	+\$6
 Storwal Electrical Module Front Cover without Cutouts	EFRCOVER-30-NC	—	30"	—	\$39	+\$5
	EFRCOVER-36-NC	—	36"	—	\$39	+\$5
	EFRCOVER-42-NC	—	42"	—	\$39	+\$5
 2" Round Storwal Glides, Black Set of 4	SWLG1-B3	—	—	—	\$25	—
	SWLG1-B3-GRY	—	—	—	\$25	—
	SWLG1-L3	—	—	—	\$23	—
	SWLG1-L3-GRY	—	—	—	\$23	—
 SuperStor Inserts	INSW13.5SS-30	13.5"	30"	10	\$93	+\$11
	INSW13.5SS-36	13.5"	36"	12	\$109	+\$12
	INSW13.5SS-42	13.5"	42"	14	\$123	+\$14
 Standard SuperStor Trays (pkg. of 6)	SWSSTRAY	—	—	6	\$212	+\$22
 Small SuperStor Trays (pkg. of 3)	SWSSTRAY-SM	—	—	3	\$109	+\$12

General information

- The Adapter Frame Filler Kit is to be installed between two Storwal units when a frame is required for space division
- The Adapter Frame End Kit is to be installed at the end of an Storwal unit
- The Adapter kit accommodates any panel 3" in thickness and less
- Competitor panel wall mount bracket is to be installed on Adapter kit in order to attach frame to kit
- Mounting hardware included with kit to attach to Storwal Storage case
- Adapter Frames allow for competitor panels to be used with Storwal

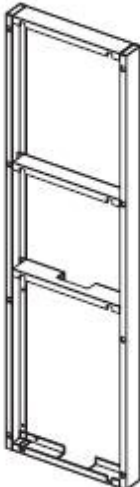
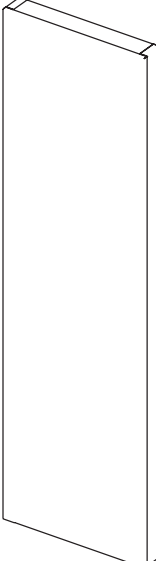
Description	Part number	Height	Width	Weight (lbs)	List price	Accent paint
 <p>Adapter Frame Filler Kit</p>	SWAFKIT3-48	48"	—	12	\$186	+\$20
	SWAFKIT3-61.5	61.5"	—	14	\$215	+\$23
	SWAFKIT3-67.5	67.5"	—	16	\$244	+\$25
 <p>Adapter Frame End Kit</p>	SWAEKIT3-48	48"	—	14	\$258	+\$27
	SWAEKIT3-61.5	61.5"	—	16	\$328	+\$34
	SWAEKIT3-67.5	67.5"	—	17	\$353	+\$36

System



Accessories

Storwal Storage

Frame to Storwal Components



General information

- Filler inserts omit small gap between the Storwal case and the frame where they join
- Must be specified with Storwal Connection Bracket (3 ½' and 2 ¾" thick frames)
- Storwal Connecting Bracket connects the frame to the Storwal unit

Description	Part number	Height	Width	Weight (lbs)	List price	Accent paint
 <p>Storwal to 1 ½" Screen Connecting Bracket</p>	SWFBKT	—	—	—	\$19	+\$3
 <p>Storwal Connecting Bracket for use with both frame thicknesses</p>	INSCBKT	—	—	—	\$79	—
 <p>Filler Insert (Pair) for use with both frame thicknesses</p>	INFIL51	51"	—	—	\$65	+\$8
	INFIL64	64"	—	—	\$72	+\$8
	INFIL71	71"	—	—	\$78	+\$9

General information

- Nuform and Veneer lateral Tops are $\frac{3}{8}$ " thick
- Lateral tops are not available with plywood edge band

Description	Part number	Width	Depth	Nuform solid/laminate	Nuform woodgrain/pattern	Grade 1 laminate	Veneer
 15" D x $\frac{3}{8}$ " T Lateral Top	INSWTOP1530	30"	15"	\$176	+\$13	+\$57	+\$297
	INSWTOP1536	36"	15"	\$190	+\$27	+\$61	+\$336
	INSWTOP1542	42"	15"	\$215	+\$30	+\$69	+\$368
	INSWTOP1548	48"	15"	\$239	+\$35	+\$77	+\$395
	INSWTOP1554	54"	15"	\$263	+\$40	+\$85	+\$418
	INSWTOP1560	60"	15"	\$325	+\$92	+\$104	+\$473
	INSWTOP1572	72"	15"	\$353	+\$109	+\$113	+\$493
	INSWTOP1578	78"	15"	\$384	+\$99	+\$123	+\$522
 18" D x $\frac{3}{8}$ " T Lateral Top	INSWTOP1830	30"	18"	\$192	+\$11	+\$62	+\$333
	INSWTOP1836	36"	18"	\$206	+\$30	+\$66	+\$379
	INSWTOP1842	42"	18"	\$232	+\$37	+\$75	+\$413
	INSWTOP1848	48"	18"	\$257	+\$44	+\$83	+\$449
	INSWTOP1854	54"	18"	\$285	+\$45	+\$92	+\$489
	INSWTOP1860	60"	18"	\$441	+\$47	+\$142	+\$846
	INSWTOP1872	72"	18"	\$527	+\$54	+\$169	+\$860
	INSWTOP1878	78"	18"	\$613	+\$63	+\$197	+\$836

Left blank intentionally.

Bench
US Price List
September 2018

Left blank intentionally.

bench

Architecture

Left blank intentionally.

Inscape bench spine

Inscape Bench spine frames are constructed of 16 gauge tubular steel uprights with welded 18 gauge steel crossrails. This strong yet lightweight construction provides ease of movement and reconfiguration.

The simplicity of the spine structure provides an intelligent solution to cable management. The absence of baseplates, apertures and corner posts eliminate barriers that restrict the routing of cables. Cabling may be routed both vertically and horizontally through the panel. Cables are laid into cable managers that easily install between panel crossrails throughout the framework. Cable managers safely cradle and segregate cables. An aperture free system means installation and reconfiguration costs are kept to a minimum. Reconfiguration is easy and economical. Cabling simply eases out of the cable managers and is laid back in at the desired point, eliminating the costly need to cut and re-terminate cables for every reconfiguration. *See Inscape Bench Application Guide for quantity of cables achievable in the various spines.

Spines

Spines do not include the electrical cover kit but may house power which is to be accessed in alternate locations with a "cut out" tile. The spine comes with one wire manager. Electrical and data components must be specified separately.

Spine glides provide 1.5" height adjustment allowing air to circulate. Spines are available in 6" increments in widths ranging from 30" wide to 60" wide.

Mid Spine Support Leg

A Mid Spine Support Leg must be specified when the Partial Height Spine or the Filing Spine are specified. This leg is a support between two spine frames. There also is a 120° and standing height version available. The legs are specific to parallel and perpendicular applications. The mid spine support legs specific to perpendicular applications are available in wood, straight metal and T metal styles. The wood style come in a Clear Maple or Black finish. The metal styles are painted and come in all standard options.

End Spine Support Leg

An End Spine Support Leg must be specified at the very end of a Partial Height Spine frame run. This leg is specific to perpendicular applications. It is available in wood, straight metal and T metal styles. The wood style come in a Clear Maple or Black finish. The metal styles are painted and come in all standard options.

90° Spine Support Leg

A 90° Spine Support Leg must be specified at the connection point when two Partial Height Benching spine frames are connected at a 90° angle. This leg is specific to perpendicular applications. It is available in wood and straight metal. The wood style come in a Clear Maple or Black finish. The metal styles are painted and come in all standard options.

Stack-on frame

The Stack-on Frame consists of a 6.75", 10.125", 13.5", 20.25" and 27" frame which may be installed on any Inscape Bench spine of the same width or combination of two frames as outlined in the Inscape Bench Application Guide only. The Stack-on frame is load bearing and can be stacked one high above spine frame. Tiles and trim are specified separately. Stack-on frames are frame thickness specific and should be specified accordingly.

Double glazed stack-on kit

Double Glazed Stack-On Kit is a stack-on with a double glazed insert. The 30" to 48" wide Double Glazed Stack-on is a fully welded frame stack-on. Double Glazed Stacks which are 54" and wider are kitted and are installed on site. The Double Glazed Stack-on is not load bearing and no stacks can be stacked on top of the Double Glaze. Finishes are available in Clear or Frosted Acrylic to match Double Glazed tile.

Trim & connectors

All Top Caps, End of Line Trim, and Connectors must be specified independently from the frame.

Inline Connectors

Inline Connectors are specified to join two units together which are in alignment. These connectors are specified based as INLINE-2 which will connect any of the Inscape Bench spines as well as the stack-ons. Be sure to specify inline connectors for the Stack-ons and Double Glaze Kits separately.

Connector trim kits

Connectors are specified independently from the inline connectors and include all necessary brackets and trim for the condition. They are available in two styles; 90° and 120°.

90° corner connectors are used in perpendicular applications only.

120° connectors are available in "Y" connectors are for 3-way connections and "V" connectors are for 2-way connections.

Top Caps

Top Caps are specified separately. The Top Cap includes clips to mount on spine or Stack-on in addition to the option of spanning two frames as outlined in the Inscape Bench Application Guide.

End Trim

End Trim is kit structured to include all brackets, bolts and finished trim; Flat profile. Trim is manufactured from aluminum and always aligns straight and true at end of the Filing spine. All painted aluminum vertical trim and top trim are easily removed to facilitate lay in of cables.

Stack-on End Trim

Stack-on End Trim is used when a higher Stack-on requires vertical end trim at a connection. Hi-Lo trim may be used in this application for Flat profile trim because there is no 'scribing' that is required for this profile.

Tiles

Tiles are available as Fabric, Painted, Tackable, Veneer, Nuform, Double Glazed, Paper Management and Whiteboard. 13.5" h tiles are interchangeable between Inscape System and Inscape Bench. Tile heights vary and must always align with the spine they are to be installed on.

ie. 23.6" h tiles = Full Height Spine, 10.125" h tiles = Stack-on, 13.5" h tiles = Partial Height and Storage Spine. Tile clips support spine tiles and top trim.

Fabric and painted tiles

Fabric and Painted Tiles are available 23.6", 10.125" and 13.5" high and are constructed of 24 gauge galvanized steel. Powder-coated and fabric-covered steel tiles have a flame spread rating of less than 200 when tested according to ASTM-E84. Fabric-covered tiles are available in standard fabrics or COM. COM fabrics are subject to approval. White or extremely light colored COM fabrics will incur an upcharge of 25% to the tile pricing with which the fabric is being applied. This is due to special handling of the fabric and tiles, in addition to painting of the tiles. Painted tiles are available in the colors shown in our Color Guide and are available in the following styles: plain steel, embossed, perforated, and steel screen. Fabric on tiles is applied in a railroad orientation.

Tackable tiles

Tackable Tiles are constructed from 24 gauge cold rolled steel with a paint finish on all surfaces to prevent corrosion. The same general rules from the fabric tile section apply to the Tackable tiles. Fabric on tiles is applied in a railroad orientation. NRC 0.57, STC 9. Tackable Acoustical tiles are available through Standard Specials with and NRC .73 and an STC of 12.

Nuform tiles

Nuform Tiles consist of white melamine-backed MDF substrate 0.375" thick, with vacuum-formed Nuform foil over the front's surface and sides. The back-side of the tile also has routing features that accept zinc die-cast tile clips. All Nuform tiles incorporate a stiffener on the rear of the tile to ensure straightness and rigidity. This stiffener limits where the tile may be placed on the Inscape Bench spine. Nuform tiles cannot be specified in a location where a power track is installed due to interference. A sticker on the back of Nuform tiles provides UL flame/smoke-rating information. Woodgrain pattern is vertical. Due to limitations in the foil size, 48" and wider tiles are not available in F06 Walnut.

Composite veneer tiles

Composite Veneer Tiles are constructed utilizing 45 lbs density particle board with an engineered balanced backer for structural integrity. Veneer thickness is 0.025". The backside of the tile has routing features that accept zinc die-cast tile clips. All Composite Veneer tiles incorporate a stiffener on the rear of the tile to ensure straightness and rigidity. This stiffener bar limits where the tile may be placed. Composite Veneer tiles cannot be specified in a location where a power track is installed due to interference on an Inscape Bench spine. Woodgrain pattern is vertical.

Whiteboard tiles

Whiteboard Tiles are available in heights of 13.5". Tiles are constructed from 24 gauge cold rolled steel with a white paint finish that has been specifically formulated for dry erase markers. Whiteboards are seamless and fit same locations as standard painted tiles.

Only Expo Markers are to be used on any Inscape Whiteboard. Whiteboards should be cleaned with Expo Eraser or a Microfiber cleaning cloth along with Expo Cleaning Solution which is formulated to remove residue from Expo Dry Erase Markers.

Paper Management Tiles

Paper Management Tiles support horizontal paper management accessories. Organizers may be positioned at any point along the width of the tile. Three slats structured into the tile allow for three different height options for the accessories to be installed. Accessories may be found under Horizontal Accessories under the "Storage and Accessories" section. Maximum load capacity is 75lbs. When specifying paper management tiles which will be supporting a monitor arm, a Paper Management Reinforcing kit is required for additional structure. The 54" and 60" w tiles are pre-structured with these kits.

Perforated and embossed tiles

Perforated and Embossed Tiles are constructed of 24 gauge galvanized steel, the Steel Screen Tiles are constructed from 24 gauge cold rolled steel. Tiles may be painted in any of Inscape's standard colors or color matches.

Communication tiles

Communication Tiles provide power OR data access. The 30" wide includes one cut out while all wider tile widths include two cut outs. Bezels in tile may be specified in black, white (close match to P168 – Glacier White) and gray (close match to P290 – Aluminum Leaf) as well with the data or electrical components. Bezels are flush with tile, NOT recessed.

Multi access tiles

Multi Access Tiles provide electrical AND data access. Cut outs align with power track and proper tiles must be specified in specific areas if stated. Data and Electrical components may be specified from the Technology section. Bezels in tile may be specified in black, white (close match to P168 – Glacier White) and gray (close match to P290 – Aluminum Leaf) as well with the data or electrical components. Bezels are flush with tile, NOT recessed.

Communication and Multi Access tiles with single sided cut outs



Communication and multi access tiles with single sided cut outs have one cut out per tile (or two above each other for multi access) and the cut outs are left or right justified making the tiles handed. They are intended to be specified so that the cut outs are hidden below the worksurface. Use one left and one right hand collaborative communication tile for each Bench Collaborative area.

Double glazed tiles

Double Glazed Tiles are available in 13.5" high and may be installed on frames 24" to 48" wide in place of a tile. Double Glazed tiles feature a double pane of frosted acrylic or clear acrylic framed by vertical and horizontal trim. Double Glazed tiles may be installed one on top of another. If wider than 60" of glaze is desired; Stack on Double Glazed kits may be specified.

General information

- 2 3/4" thick spine when clad with tiles
- Power Track Kit (Upper Deck) only - no electrical clips included
- Includes one cable hook
- Bench spine frames come standard with rectangular glides. Black and gray options available

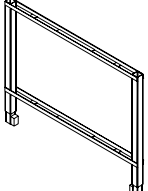
Description	Part number	Height	Width	Thickness	List price
 <p>Full Height Benching Spine</p>	INBFHF2730	27"	30"	2 3/4"	\$177
	INBFHF2736	27"	36"	2 3/4"	\$182
	INBFHF2742	27"	42"	2 3/4"	\$185
	INBFHF2748	27"	48"	2 3/4"	\$188
	INBFHF2754	27"	54"	2 3/4"	\$191
	INBFHF2760	27"	60"	2 3/4"	\$221
 <p>Partial Height Benching Spine</p>	INBPHF13.530	13.5"	30"	2 3/4"	\$144
	INBPHF13.536	13.5"	36"	2 3/4"	\$148
	INBPHF13.542	13.5"	42"	2 3/4"	\$152
	INBPHF13.548	13.5"	48"	2 3/4"	\$155
	INBPHF13.554	13.5"	54"	2 3/4"	\$161
	INBPHF13.560	13.5"	60"	2 3/4"	\$188
 <p>Storage Anchored Benching Spine</p>	INBFF30	13.5"	30"	2 3/4"	\$159
	INBFF36	13.5"	36"	2 3/4"	\$162
	INBFF42	13.5"	42"	2 3/4"	\$166
	INBFF48	13.5"	48"	2 3/4"	\$170
	INBFF54	13.5"	54"	2 3/4"	\$173
	INBFF60	13.5"	60"	2 3/4"	\$200
 <p>Standing Height, Partial Height Spine</p>	INBSHF2730	27"	30"	2 3/4"	\$178
	INBSHF2736	27"	36"	2 3/4"	\$183
	INBSHF2742	27"	42"	2 3/4"	\$187
	INBSHF2748	27"	48"	2 3/4"	\$190
	INBSHF2754	27"	54"	2 3/4"	\$193
	INBSHF2760	27"	60"	2 3/4"	\$223

Architecture

Spines





Stack-on Frames

General information

- 2 ¾" thick when clad with tiles
- No Twin Bin placement on the 13.5" H Stack-on
- 20.25" H requires an additional crossrail (separately) if Twin Bin or 13.5" H tile being specified
- Fully welded stack on kits easily installed and removed to adjust panel height
- Load bearing
- Stack on frames may span multiple frames
- See Application Guide for spanning guidelines

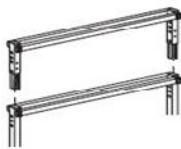
Note

With the exception of the 10.125" H stack-on frame, standard Inscape System tiles can be used for Bench Stack-On frames.

Description	Part number	Height	Width	Thickness	List price
 6.75" H Single Stack-On, 2 ¾" T	INSF030-2F	6.75"	30"	2 ¾"	\$140
	INSF036-2F	6.75"	36"	2 ¾"	\$143
	INSF042-2F	6.75"	42"	2 ¾"	\$146
	INSF048-2F	6.75"	48"	2 ¾"	\$151
	INSF054-2F	6.75"	54"	2 ¾"	\$152
	INSF060-2F	6.75"	60"	2 ¾"	\$155
 10.125" H Single Stack-On, 2 ¾" T	INSF1030-2F	10.125"	30"	2 ¾"	\$142
	INSF1036-2F	10.125"	36"	2 ¾"	\$145
	INSF1042-2F	10.125"	42"	2 ¾"	\$148
	INSF1048-2F	10.125"	48"	2 ¾"	\$154
	INSF1054-2F	10.125"	54"	2 ¾"	\$155
	INSF1060-2F	10.125"	60"	2 ¾"	\$159
 13.5" H Single Stack-On, 2 ¾" T	INSF130-2F	13.5"	30"	2 ¾"	\$144
	INSF136-2F	13.5"	36"	2 ¾"	\$147
	INSF142-2F	13.5"	42"	2 ¾"	\$151
	INSF148-2F	13.5"	48"	2 ¾"	\$156
	INSF154-2F	13.5"	54"	2 ¾"	\$159
	INSF160-2F	13.5"	60"	2 ¾"	\$160
 20.25" H Single Stack-On, 2 ¾" T	INSF2030D-2F	20.25"	30"	2 ¾"	\$154
	INSF2036D-2F	20.25"	36"	2 ¾"	\$159
	INSF2042D-2F	20.25"	42"	2 ¾"	\$162
	INSF2048D-2F	20.25"	48"	2 ¾"	\$165
	INSF2054D-2F	20.25"	54"	2 ¾"	\$166
	INSF2060D-2F	20.25"	60"	2 ¾"	\$168
 27" H Single Stack-On, 2 ¾" T	INSF230-2F	27"	30"	2 ¾"	\$168
	INSF236-2F	27"	36"	2 ¾"	\$172
	INSF242-2F	27"	42"	2 ¾"	\$174
	INSF248-2F	27"	48"	2 ¾"	\$179
	INSF254-2F	27"	54"	2 ¾"	\$180
	INSF260-2F	27"	60"	2 ¾"	\$181

General information

- Stack on Double Glaze is non-load bearing
- Stack on Double Glaze may span two frames. See Application Guide for spanning guidelines
- 30" to 48" wide kits consist of welded frames
- 54" to 96" wide kits are kitted and must be assembled on-site
- Clear and Frosted Acrylic options available
- May be located in the top location only

- Be sure to specify correct thickness of stack-on frame based on the frame it is being installed on

Note

In order to get a total cost on products when upcharges are present take the list price of the product number and add the upcharge cost shown to the list price.

For example:

Product INSTGL30-2F in Frosted Acrylic would be \$453 +\$79

Description	Part number	Height	Width	Thickness	List price	Frosted acrylic	Accent paint
 13.5" H Double Glaze Stack-On Acrylic	INSTGL30-2F	13.5"	30"	2 3/4"	\$453	+\$79	+\$46
	INSTGL36-2F	13.5"	36"	2 3/4"	\$518	+\$89	+\$52
	INSTGL42-2F	13.5"	42"	2 3/4"	\$562	+\$98	+\$57
	INSTGL48-2F	13.5"	48"	2 3/4"	\$622	+\$108	+\$63
	INSTGL54-2F	13.5"	54"	2 3/4"	\$682	+\$106	+\$70
	INSTGL60-2F	13.5"	60"	2 3/4"	\$751	+\$117	+\$76
	INSTGL66-2F	13.5"	66"	2 3/4"	\$799	+\$138	+\$81
	INSTGL72-2F	13.5"	72"	2 3/4"	\$823	+\$141	+\$83
	INSTGL78-2F	13.5"	78"	2 3/4"	\$848	+\$145	+\$86
	INSTGL84-2F	13.5"	84"	2 3/4"	\$871	+\$148	+\$88
	INSTGL90-2F	13.5"	90"	2 3/4"	\$898	+\$154	+\$91
INSTGL96-2F	13.5"	96"	2 3/4"	\$922	+\$158	+\$93	





Architecture

Spines

Spine Support Legs



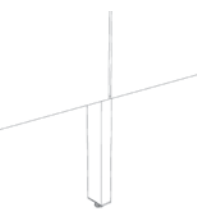
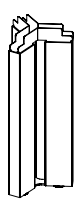

General information

- Mid spine support legs supports the Partial Height Benching spine when it is placed adjacent to another inline
- Glide option on spine support legs are black and gray with the exception on the perpendicular application legs coming in black only
- Wood spine support legs are available in Clear Maple and Black finishes
- Straight and T metal spine support legs are painted and available in all standard colors
- For freestanding height adjustable perpendicular applications the Metal T Legs must be use with a Bench Height Adjustable Foot Docking Bracket. See Worksurface Support setion of this price list
- The Height Adjustable Tables (2 or 3 stage base) found in the Ergonomic Price List are compatable with perpendicular applications in 48", 54" and 60" widths only

Description	Part number	Height	List price	Accent paint option
 <p>Mid Spine Support Leg for parallel applications only</p>	INBMSL10	10"	\$215	+\$23
 <p>Straight Wood Partial Height Bench Frame Mid Spine Support Leg for perpendicular applications only</p>	INBMSLW10	10"	\$254	—
 <p>Metal T Partial Height Bench Frame Mid Spine Support Leg for perpendicular applications only</p>	INBMSLT10	10"	\$334	+\$34
 <p>Straight Metal Partial Height Bench Frame Mid Spine Support Leg for perpendicular applications only</p>	INBMSLSM10	10"	\$215	+\$23
 <p>120° Mid Spine Support Leg</p>	INBYMSL10	10"	\$215	+\$23
 <p>Standing Height Mid Spine Support Leg</p>	INBMSL13	13"	\$228	+\$24

General information

- End spine support leg supports the very end Partial Height Benching spine run
- 90° spine support legs supports the connection point when two Partial Height Benching spine frames are connected at a 90° angle
- Glide option on spine support legs is black
- Wood spine support legs are available in Clear Maple and Black finishes
- Straight and T metal spine support legs are painted and available in all standard colors
- Metal 90° spine support legs are intended to be installed on the worksurface supporting spine
- Metal 90° spine support legs are shipped right handed. if left handed is required, the legs can be field adjusted
- For freestanding height adjustable perpendicular applications the Metal T Legs must be use with a Bench Height Adjustable Foot Docking Bracket. See Worksurface Support setion of this price list
- The Height Adjustable Tables (2 or 3 stage base) found in the Ergonomic Price List are compatible with perpendicular applications in 48" , 54" and 60" widths only

Description	Part number	Height	List price	Accent paint option
 <p>Straight Wood Partial Height Bench Frame End Spine Support Leg for perpendicular applications only</p>	INBESLW10	10"	\$254	—
 <p>Metal T Partial Height Bench Frame End Spine Support Leg for perpendicular applications only</p>	INBESLT10	10"	\$310	+\$23
 <p>Straight Metal Partial Height Bench Frame End Spine Support Leg for perpendicular applications only</p>	INBESLSM10	10"	\$215	+\$23
 <p>Straight Wood Partial Height Bench Frame 90° Spine Support Leg for perpendicular applications only</p>	INB90SLW10	10"	\$254	—
 <p>Straight Metal Partial Height Bench Frame 90° Spine Support Leg for perpendicular applications only</p>	INB90SLSM10	10"	\$215	+\$23

Architecture

Connectors and Trim

General information

- Inline Connectors are required to be specified when frames are connected inline
- Specified independently of frame and may span two frames.
- See Inscape System Application Guide
- All mounting hardware is included for corresponding frame thickness
- Veneer trim is up to a maximum length of 48"
- Top Trim up to 60"w requires two additional Jesters to be specified if spanning multiple frames (i.e. a 60"w top trim installed on two 30" frames)
- Veneer trim available in specific height only (not 10.125" height)
- Stack-on End Trim (Hi-Lo End Trim) is specified when stack frames are specified
- End of line trim is specified when storage is being specified and there is visibility to the end of the frame (all other end conditions include finished appearance with no end trim needed)
- End of line trim can not be used on a stack on frame

Note

In order to get a total cost on products when upcharges are present take the list price of the product number and add the upcharge cost shown to the list price.

For example:

Product INTC30-2F in Veneer would be \$51 +\$170

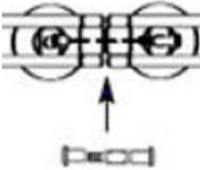
Description	Part number	Height	List price
	INLINE-1	All Stack on Frame	\$0
	INLINE-2	24"h - 51"h Frame	\$0

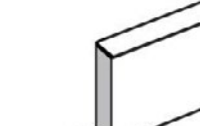

Description	Part number	Height	Width	Thickness	Flat/ Neutral paint/ base price	Veneer	Accent paint
	INTC30-2F	—	30"	2 3/4"	\$51	+\$170	+\$6
	INTC36-2F	—	36"	2 3/4"	\$56	+\$189	+\$7
	INTC42-2F	—	42"	2 3/4"	\$61	+\$210	+\$7
	INTC48-2F	—	48"	2 3/4"	\$63	+\$231	+\$8
	INTC54-2F	—	54"	2 3/4"	\$78	—	+\$9
	INTC60-2F	—	60"	2 3/4"	\$83	—	+\$10
	INTC66-2F	—	66"	2 3/4"	\$97	—	+\$11
	INTC72-2F	—	72"	2 3/4"	\$101	—	+\$11
	INTC78-2F	—	78"	2 3/4"	\$108	—	+\$12
	INTC84-2F	—	84"	2 3/4"	\$118	—	+\$13
	INTC90-2F	—	90"	2 3/4"	\$122	—	+\$13
	INTC96-2F	—	96"	2 3/4"	\$125	—	+\$14

	INETHL6.75-2F	6.75"	—	2 3/4"	\$23	—	+\$4
	INBET10.125-2F	10.125"	—	2 3/4"	\$29	—	+\$4
	INETHL13.5-2F	13.5"	—	2 3/4"	\$35	+\$77	+\$5
	INETHL20.25-2F	20.25"	—	2 3/4"	\$43	—	+\$6
	INETHL27-2F	27"	—	2 3/4"	\$67	+\$104	+\$8

	INBET13.5-2F	13.5"	—	2 3/4"	\$33	—	+\$5
	For use with Partial Height Frames						
	INBETEND27-2F	25.61"	—	2 3/4"	\$45	—	+\$6
	For use with Full Height Frames						

General information

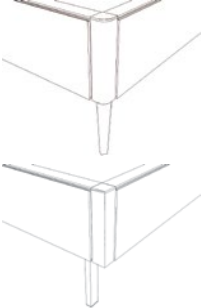
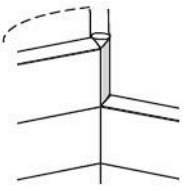
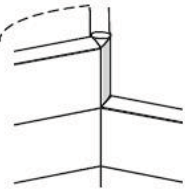
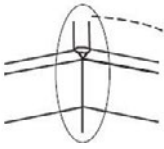
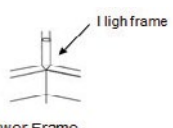
- Connector Kits include connector brackets, bolts, nuts and finished trim to create connection
- Specify code based on height of frames within connection
- Full Height to Partial Height Spine Trim finishes the full height bench frame when adjacent (inline) to a partial height spine frame

Description	Part number	Height	List price	Accent paint
 <p>90° Corner Connector for perpendicular applications only</p>	INBCPLC13.5-2F with rounded profile	13.5"	\$58	+\$7
	INBCPLS13.5-2F with straight profile	13.5"	\$58	+\$7
 <p>120° Y Connector, Partial Height 2 ¾" Thick Frame - same height configurations</p>	INCPYBPH-2F	13.5"	\$66	+\$8
	INCPYBFH-2F	27"	\$145	+\$16
 <p>120° Stack-On "V" Connector</p>	INCPV6.75-2F	6.75"	\$156	+\$17
	INCPV10-2F	10.125"	\$161	+\$17
	INCPV13.5-2F	13.5"	\$164	+\$18
 <p>120° Stack-On "Y" Connector</p>	INCPY6.75-2F	6.75"	\$16	+\$3
	INCPY10-2F	10.125"	\$18	+\$3
	INCPY13.5-2F	13.5"	\$21	+\$3
 <p>120° Stack-On End Trim, Multi Height</p> <p>High frame</p> <p>Lower Frame</p>	INST6.75Y-2F	6.75"	\$156	+\$17
	INST10Y-2F	10.125"	\$161	+\$17
	INST13.5Y-2F	13.5"	\$164	+\$18
 <p>Full Height to Partial Height Spine Trim</p>	INBPFHETC10	10"	\$65	+\$7



Architecture

Tiles

Full Height Spine Tiles

General information

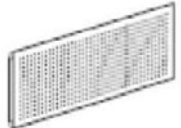
- 23.6" h tiles may only be mounted on Full Height bench spine
- Communication Tiles include cutouts for power and data
- Multi Access Tiles include cutouts for power and data
- Communication Tiles include cutouts for power or data
- Collaborative tiles have one cutout per tile and the cutouts are left or right justified making the tiles handed. They are intended to be specified to hide below the worksurface. Use one left and one right hand for each Bench Collaborative area

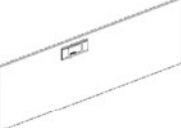
Description	Part number	Height	Width	Neutral paint/ base price	Accent paint	
	23.6" H Painted Tile	INB23.6P30	23.625"	30"	\$82	+\$9
		INB23.6P36	23.625"	36"	\$97	+\$11
		INB23.6P42	23.625"	42"	\$103	+\$12
		INB23.6P48	23.625"	48"	\$117	+\$13
		INB23.6P54	23.625"	54"	\$126	+\$14
		INB23.6P60	23.625"	60"	\$145	+\$16
	23.6" H Perforated Tile	INB23.6PF30	23.625"	30"	\$91	+\$10
		INB23.6PF36	23.625"	36"	\$109	+\$12
		INB23.6PF42	23.625"	42"	\$117	+\$13
		INB23.6PF48	23.625"	48"	\$138	+\$15
		INB23.6PF54	23.625"	54"	\$153	+\$16
		INB23.6PF60	23.625"	60"	\$168	+\$18
	23.6" H Painted Communication Tile	INB23.6CTP30	23.625"	30"	\$154	+\$17
		INB23.6CTP36	23.625"	36"	\$159	+\$17
		INB23.6CTP42	23.625"	42"	\$167	+\$18
		INB23.6CTP48	23.625"	48"	\$176	+\$19
		INB23.6CTP54	23.625"	54"	\$195	+\$21
		INB23.6CTP60	23.625"	60"	\$199	+\$21
	23.6" H Painted Multi Access Tile	INB23.6MAP30	23.625"	30"	\$154	+\$17
		INB23.6MAP36	23.625"	36"	\$159	+\$17
		INB23.6MAP42	23.625"	42"	\$167	+\$18
		INB23.6MAP48	23.625"	48"	\$176	+\$19
		INB23.6MAP54	23.625"	54"	\$195	+\$21
		INB23.6MAP60	23.625"	60"	\$199	+\$21
	23.6" H Painted Collaborative Communication Tile with single sided cutouts	INBCLB23CTP36UL	23.625"	36"	\$148	+\$16
		INBCLB23CTP42UL	23.625"	42"	\$155	+\$17
		INBCLB23CTP36UR	23.625"	36"	\$148	+\$16
		INBCLB23CTP42UR	23.625"	42"	\$155	+\$17

Description	Part number	Height	Width	Grade 1/ COM	Grade 2	Grade 3	Grade 4	Grade 5	Grade 6	Grade 7	Grade 8	Scrim
	INBCLB23CTF36UL	23.625"	36"	\$150	+\$8	+\$19	+\$30	+\$41	+\$72	+\$102	+\$143	+\$26
	INBCLB23CTF42UL	23.625"	42"	\$153	+\$10	+\$22	+\$32	+\$43	+\$75	+\$106	+\$148	+\$29
	INBCLB23CTF36UR	23.625"	36"	\$150	+\$8	+\$19	+\$30	+\$41	+\$72	+\$102	+\$143	+\$26
	INBCLB23CTF42UR	23.625"	42"	\$153	+\$10	+\$22	+\$32	+\$43	+\$75	+\$106	+\$148	+\$29
23.6" H Fabric Collaborative Communication Tile with single sided cutouts												

General information

- 13.5" h tile may be specified with Partial Height Spine or Filing Spine
- Tiles are standard 13.5" h Inscape System
- 13.5" H Tiles may be specified on 13.5" stack on frame
- Tiles 66" W or wide span two frames. See Application Guide for frame spanning guidelines

Note

See finishes section for fabrics that require scrim

Tile size limitations exist for some fabrics, see finishes section

In order to get a total cost on products when upcharges are present take the list price of the product number and add the upcharge cost shown to the list price.

For example:

Product IN13.5F18 in a Grade 5 Fabric with Scrim would be \$84 +\$26 +\$12

Description	Part number	Height	Width	Neutral paint/ base price	Accent paint
	IN13.5P30	13.5"	30"	\$61	+\$7
	IN13.5P36	13.5"	36"	\$62	+\$8
	IN13.5P42	13.5"	42"	\$64	+\$8
	IN13.5P48	13.5"	48"	\$66	+\$8
	IN13.5P54	13.5"	54"	\$69	+\$8
	IN13.5P60	13.5"	60"	\$73	+\$9
	IN13.5PF30	13.5"	30"	\$73	+\$9
	IN13.5PF36	13.5"	36"	\$74	+\$9
	IN13.5PF42	13.5"	42"	\$75	+\$9
	IN13.5PF48	13.5"	48"	\$78	+\$9
	IN13.5PF54	13.5"	54"	\$79	+\$9
	IN13.5PF60	13.5"	60"	\$81	+\$9

Description	Part number	Height	Width	Grade 1/ COM	Grade 2	Grade 3	Grade 4	Grade 5	Grade 6	Grade 7	Grade 8	Scrim
	IN13.5F18	13.5"	18"	\$84	+\$4	+\$18	+\$20	+\$26	+\$38	+\$52	+\$74	+\$12
	IN13.5F24	13.5"	24"	\$87	+\$4	+\$20	+\$23	+\$29	+\$37	+\$51	+\$73	+\$12
	IN13.5F30	13.5"	30"	\$91	+\$5	+\$22	+\$28	+\$32	+\$37	+\$52	+\$74	+\$13
	IN13.5F36	13.5"	36"	\$95	+\$9	+\$22	+\$30	+\$37	+\$58	+\$79	+\$110	+\$13
	IN13.5F42	13.5"	42"	\$100	+\$11	+\$23	+\$31	+\$39	+\$62	+\$84	+\$117	+\$14
	IN13.5F48	13.5"	48"	\$103	+\$11	+\$23	+\$31	+\$39	+\$62	+\$85	+\$118	+\$14
	IN13.5F54	13.5"	54"	\$106	+\$12	+\$24	+\$34	+\$44	+\$69	+\$92	+\$128	+\$16
	IN13.5F60	13.5"	60"	\$111	+\$12	+\$24	+\$34	+\$44	+\$69	+\$92	+\$128	+\$16
	IN13.5F66	13.5"	66"	\$207	+\$13	+\$24	+\$34	+\$44	+\$70	+\$93	+\$130	+\$80
	IN13.5F72	13.5"	72"	\$211	+\$13	+\$14	+\$21	+\$28	+\$57	+\$85	+\$118	+\$81
	IN13.5F78	13.5"	78"	\$212	+\$13	+\$16	+\$23	+\$30	+\$61	+\$91	+\$127	+\$81
	IN13.5F84	13.5"	84"	\$222	+\$14	+\$16	+\$23	+\$30	+\$61	+\$91	+\$127	+\$82
	IN13.5F90	13.5"	90"	\$223	+\$14	+\$17	+\$26	+\$34	+\$66	+\$97	+\$135	+\$101
IN13.5F96	13.5"	96"	\$225	+\$15	+\$18	+\$28	+\$37	+\$71	+\$102	+\$143	+\$101	
	IN13.5TK18	13.5"	18"	\$126	+\$4	+\$8	+\$16	+\$24	+\$43	+\$63	+\$88	+\$21
	IN13.5TK24	13.5"	24"	\$130	+\$5	+\$9	+\$17	+\$24	+\$44	+\$64	+\$89	+\$23
	IN13.5TK30	13.5"	30"	\$134	+\$6	+\$9	+\$17	+\$24	+\$45	+\$66	+\$92	+\$24
	IN13.5TK36	13.5"	36"	\$138	+\$9	+\$18	+\$27	+\$36	+\$63	+\$89	+\$124	+\$25
	IN13.5TK42	13.5"	42"	\$142	+\$10	+\$19	+\$28	+\$37	+\$65	+\$92	+\$128	+\$27
IN13.5TK48	13.5"	48"	\$162	+\$10	+\$19	+\$30	+\$40	+\$71	+\$99	+\$139	+\$28	



Architecture

Tiles

Partial Height Spine Tiles

General information

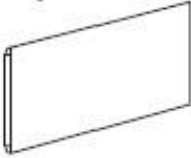
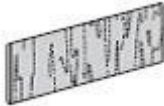
- 13.5" h tile may be specified with Partial Height Spine or Filing Spine
- Tiles are standard 13.5" h Inscape System
- May be specified on Stack-On Frame
- Multi Access Tiles include cutouts for power and data
- Communication Tiles include cutouts for power or data
- When specifying monitor arms to mount on paper management tile, reinforcing bracket must be specified
- Reinforcement Kit includes reinforcing brackets for Paper Management Tile

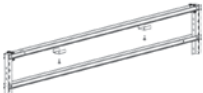
Description	Part number	Height	Width	List price	Accent paint
 13.5" H Nuform Tile	IN13.5NF30	13.5"	30"	\$228	—
	IN13.5NF36	13.5"	36"	\$237	—
	IN13.5NF42	13.5"	42"	\$248	—
	IN13.5NF48	13.5"	48"	\$255	—
 13.5" H Veneer Tile	IN13.5WV30	13.5"	30"	\$280	—
	IN13.5WV36	13.5"	36"	\$311	—
	IN13.5WV42	13.5"	42"	\$344	—
	IN13.5WV48	13.5"	48"	\$375	—
 13.5" H Whiteboard Tile	IN13.5WB30	13.5"	30"	\$89	—
	IN13.5WB36	13.5"	36"	\$91	—
	IN13.5WB42	13.5"	42"	\$93	—
	IN13.5WB48	13.5"	48"	\$98	—
	IN13.5WB54	13.5"	54"	\$109	—
	IN13.5WB60	13.5"	60"	\$114	—
	IN13.5WB66	13.5"	66"	\$197	—
	IN13.5WB72	13.5"	72"	\$202	—
	IN13.5WB78	13.5"	78"	\$212	—
	IN13.5WB84	13.5"	84"	\$217	—
IN13.5WB90	13.5"	90"	\$222	—	
IN13.5WB96	13.5"	96"	\$227	—	
 6.75" H Paper Management Tile for use with 2 3/4" T frames	IN6.75PM30-2F	6.75"	30"	\$138	+\$15
	IN6.75PM36-2F	6.75"	36"	\$151	+\$16
	IN6.75PM42-2F	6.75"	42"	\$168	+\$18
	IN6.75PM48-2F	6.75"	48"	\$183	+\$19
	IN6.75PM54-2F	6.75"	54"	\$197	+\$21
	IN6.75PM60-2F	6.75"	60"	\$216	+\$23
	IN6.75PM66-2F	6.75"	66"	\$285	+\$29
	IN6.75PM72-2F	6.75"	72"	\$296	+\$31
	IN6.75PM78-2F	6.75"	78"	\$306	+\$32
	IN6.75PM84-2F	6.75"	84"	\$349	+\$36
IN6.75PM90-2F	6.75"	90"	\$360	+\$37	
IN6.75PM96-2F	6.75"	96"	\$373	+\$38	
 Paper Management Reinforcing Kit for use with 2 3/4" T frames	INPMRK-2F	—	18"	\$108	—

General information

- 13.5" h tile may be specified with Partial Height Spine or Filing Spine
- Tiles are standard 13.5" h Inscape System
- 13.5" H tiles may be specified on 13.5" Stack-On Frame
- Multi Access Tiles include cutouts for power and data
- Communication Tiles include cutouts for power or data
- Collaborative communication and multi access tiles with single sided cutouts have one cutout per tile (2 stacked for multi access) and the cutouts are left or right justified making the tiles handed. They are intended to be specified so that the cutouts are hidden below the worksurface

- Use one left and one right hand collaborative communication tile for each Bench Collaborative area

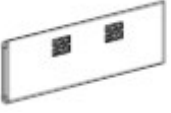
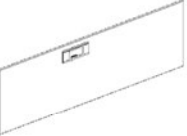
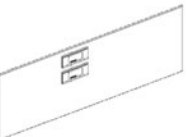
Description	Part number	Height	Width	List price	Accent paint
 13.5" H Painted Communication Tile Upper Deck Location	IN13.5CTP24-UD	13.5"	24"	\$85	+\$10
	IN13.5CTP30-UD	13.5"	30"	\$88	+\$10
	IN13.5CTP36-UD	13.5"	36"	\$93	+\$11
	IN13.5CTP42-UD	13.5"	42"	\$97	+\$11
	IN13.5CTP48-UD	13.5"	48"	\$102	+\$11
	IN13.5CTP54-UD	13.5"	54"	\$103	+\$12
 13.5" H Painted Multi Access Tile	IN13.5MAP30-UD	13.5"	30"	\$89	+\$10
	IN13.5MAP36-UD	13.5"	36"	\$93	+\$11
	IN13.5MAP42-UD	13.5"	42"	\$97	+\$11
	IN13.5MAP48-UD	13.5"	48"	\$102	+\$11
	IN13.5MAP54-UD	13.5"	54"	\$103	+\$12
	IN13.5MAP60-UD	13.5"	60"	\$106	+\$12
 13.5" H Painted Collaborative Communication Tile with single sided cutouts	INBCLB13CTP36UL	13.5"	36"	\$82	+\$9
	INBCLB13CTP42UL cutout on the left (illustrated)	13.5"	42"	\$87	+\$10
	INBCLB13CTP36UR	13.5"	36"	\$82	+\$9
	INBCLB13CTP42UR cutout on the right	13.5"	42"	\$87	+\$10
 13.5" H Painted Multi Access Tile with single sided cutouts	IN13.5MAP60UL	13.5"	60"	\$106	+\$12
	IN13.5MAP72UL cutout on the left (illustrated)	13.5"	72"	\$207	+\$22
	IN13.5MAP60UR	13.5"	60"	\$106	+\$12
	IN13.5MAP72UR cutout on the right	13.5"	72"	\$207	+\$22

Architecture

Tiles

Partial Height Spine Tiles

General information

- 13.5" h tile may be specified with Partial Height Spine or Filing Spine
- Tiles are standard 13.5" h Inscape System
- 13.5" H tiles may be specified on 13.5" Stack-On Frame
- Multi Access Tiles include cutouts for power and data
- Communication Tiles include cutouts for power or data
- Collaborative communication and multi access tiles with single sided cutouts have one cutout per tile (2 stacked for multi access) and the cutouts are left or right justified making the tiles handed. They are intended to be specified so that the cutouts are hidden below the worksurface
- Use one left and one right hand collaborative communication tile for each Bench Collaborative area

Note



See finishes section for fabrics that require scrim

Tile size limitations exist for some fabrics, see finishes section

In order to get a total cost on products when upcharges are present take the list price of the product number and add the upcharge cost shown to the list price.

For example:

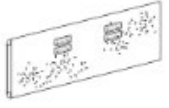
Product IN13.5CTF24-UD in a Grade 5 Fabric with Scrim would be \$98 +\$26 +\$12

Description	Part number	Height	Width	Grade 1/ COM	Grade 2	Grade 3	Grade 4	Grade 5	Grade 6	Grade 7	Grade 8	Scrim
 13.5" H Fabric Communication Tile Upper Deck Location	IN13.5CTF24-UD	13.5"	24"	\$98	+\$6	+\$11	+\$19	+\$26	+\$46	+\$67	+\$94	+\$12
	IN13.5CTF30-UD	13.5"	30"	\$102	+\$5	+\$9	+\$17	+\$24	+\$45	+\$66	+\$92	+\$13
	IN13.5CTF36-UD	13.5"	36"	\$113	+\$6	+\$12	+\$23	+\$33	+\$59	+\$84	+\$117	+\$13
	IN13.5CTF42-UD	13.5"	42"	\$116	+\$7	+\$16	+\$24	+\$32	+\$61	+\$86	+\$121	+\$14
	IN13.5CTF48-UD	13.5"	48"	\$120	+\$9	+\$21	+\$30	+\$38	+\$65	+\$92	+\$128	+\$14
	IN13.5CTF54-UD	13.5"	54"	\$121	+\$10	+\$23	+\$33	+\$42	+\$71	+\$98	+\$138	+\$16
	IN13.5CTF60-UD	13.5"	60"	\$132	+\$11	+\$12	+\$23	+\$34	+\$63	+\$91	+\$127	+\$16
 13.5" H Fabric Multi Access Tile Upper Deck Location	IN13.5MAF30-UD	13.5"	30"	\$103	+\$5	+\$9	+\$17	+\$24	+\$45	+\$66	+\$92	+\$13
	IN13.5MAF36-UD	13.5"	36"	\$113	+\$6	+\$12	+\$23	+\$33	+\$59	+\$84	+\$117	+\$13
	IN13.5MAF42-UD	13.5"	42"	\$116	+\$7	+\$19	+\$24	+\$36	+\$62	+\$89	+\$124	+\$14
	IN13.5MAF48-UD	13.5"	48"	\$120	+\$9	+\$21	+\$30	+\$38	+\$65	+\$92	+\$128	+\$14
	IN13.5MAF54-UD	13.5"	54"	\$121	+\$10	+\$23	+\$33	+\$42	+\$71	+\$98	+\$138	+\$16
	IN13.5MAF60-UD	13.5"	60"	\$132	+\$11	+\$25	+\$35	+\$44	+\$74	+\$100	+\$140	+\$16
 13.5" H Fabric Collaborative Communication Tile with single sided cutouts	INBCLB13CTF36UL	13.5"	36"	\$102	+\$5	+\$11	+\$22	+\$32	+\$57	+\$82	+\$114	+\$12
	INBCLB13CTF42UL cutout on the left (illustrated)	13.5"	42"	\$107	+\$6	+\$15	+\$23	+\$35	+\$59	+\$85	+\$118	+\$13
	INBCLB13CTF36UR	13.5"	36"	\$102	+\$5	+\$11	+\$22	+\$32	+\$57	+\$82	+\$114	+\$12
	INBCLB13CTF42UR cutout on the right	13.5"	42"	\$107	+\$6	+\$15	+\$23	+\$35	+\$59	+\$85	+\$118	+\$13
 13.5" H Fabric Multi Access Tile with single sided cutouts	IN13.5MAF60UL	13.5"	60"	\$132	+\$12	+\$24	+\$34	+\$44	+\$69	+\$92	+\$128	+\$16
	IN13.5MAF72UL cutout on the left (illustrated)	13.5"	72"	\$257	+\$22	+\$45	+\$64	+\$84	+\$130	+\$174	+\$244	+\$46
	IN13.5MAF60UR	13.5"	60"	\$132	+\$12	+\$24	+\$34	+\$44	+\$69	+\$92	+\$128	+\$16
	IN13.5MAF72UR cutout on the right	13.5"	72"	\$257	+\$22	+\$45	+\$64	+\$84	+\$130	+\$174	+\$244	+\$46

General information

- Tiles may only be installed on 10.125" H Stack on
- May be specified op Stack-On Frame
- Multi Access Tiles include cutouts for power and data
- Communication Tiles include cutouts for power or data

Note



See finishes section for fabrics that require scrim



Tile size limitations exist for some fabrics, see finishes section

In order to get a total cost on products when upcharges are present take the list price of the product number and add the upcharge cost shown to the list price.

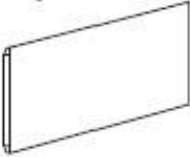
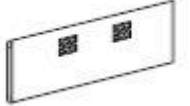
For example:

Product IN10.125F30 in a Grade 5 Fabric with Scrim would be \$91 +\$22 +\$13

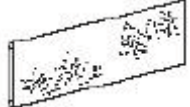
Description	Part number	Height	Width	List price	Accent paint	
	10.125" H Painted Tile	IN10.125P30	10.125"	30"	\$61	+\$7
		IN10.125P36	10.125"	36"	\$62	+\$8
		IN10.125P42	10.125"	42"	\$64	+\$8
		IN10.125P48	10.125"	48"	\$66	+\$8
		IN10.125P54	10.125"	54"	\$69	+\$8
		IN10.125P60	10.125"	60"	\$73	+\$9
	10.125" H Painted Multi-Access Tile	IN10.12MAP30-UD	10.125"	30"	\$88	+\$10
		IN10.12MAP36-UD	10.125"	36"	\$93	+\$11
		IN10.12MAP42-UD	10.125"	42"	\$97	+\$11
		IN10.12MAP48-UD	10.125"	48"	\$102	+\$11
		IN10.12MAP54-UD	10.125"	54"	\$103	+\$12
		IN10.12MAP60-UD	10.125"	60"	\$106	+\$12
	10.125" H Painted Communication Tile	IN10.12CTP30-UD	10.125"	30"	\$88	+\$10
		IN10.12CTP36-UD	10.125"	36"	\$93	+\$11
		IN10.12CTP42-UD	10.125"	42"	\$97	+\$11
		IN10.12CTP48-UD	10.125"	48"	\$102	+\$11
		IN10.12CTP54-UD	10.125"	54"	\$103	+\$12
		IN10.12CTP60-UD	10.125"	60"	\$106	+\$12

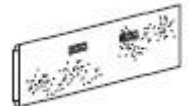
Description	Part number	Height	Width	Grade 1/ COM	Grade 2	Grade 3	Grade 4	Grade 5	Grade 6	Grade 7	Grade 8	Scrim	
	10.125" H Fabric Tile	IN10.125F30	10.125"	30"	\$91	+\$5	+\$9	—	+\$22	—	+\$52	—	+\$13
		IN10.125F36	10.125"	36"	\$95	+\$9	+\$22	—	+\$37	—	+\$79	—	+\$13
		IN10.125F42	10.125"	42"	\$100	+\$8	+\$23	—	+\$39	—	+\$84	—	+\$14
		IN10.125F48	10.125"	48"	\$103	+\$11	+\$23	—	+\$39	—	+\$85	—	+\$14
		IN10.125F54	10.125"	54"	\$106	+\$12	+\$24	—	+\$44	—	+\$92	—	+\$16
		IN10.125F60	10.125"	60"	\$111	+\$12	+\$24	—	+\$44	—	+\$92	—	+\$16
	10.125" H Fabric Multi-Access Tile	IN10.12MAF30-UD	10.125"	30"	\$102	+\$5	+\$9	—	+\$24	—	+\$66	—	+\$13
		IN10.12MAF36-UD	10.125"	36"	\$113	+\$6	+\$12	—	+\$33	—	+\$84	—	+\$13
		IN10.12MAF42-UD	10.125"	42"	\$116	+\$5	+\$16	—	+\$32	—	+\$84	—	+\$14
		IN10.12MAF48-UD	10.125"	48"	\$120	+\$9	+\$21	—	+\$38	—	+\$92	—	+\$14
		IN10.12MAF54-UD	10.125"	54"	\$121	+\$10	+\$23	—	+\$42	—	+\$98	—	+\$16
		IN10.12MAF60-UD	10.125"	60"	\$132	+\$3	+\$12	—	+\$34	—	+\$91	—	+\$16
	10.125" H Fabric Communication Tile	IN10.12CTF30-UD	10.125"	30"	\$102	+\$5	+\$9	—	+\$24	—	+\$66	—	+\$13
		IN10.12CTF36-UD	10.125"	36"	\$113	+\$6	+\$12	—	+\$33	—	+\$84	—	+\$13
		IN10.12CTF42-UD	10.125"	42"	\$116	+\$5	+\$16	—	+\$32	—	+\$84	—	+\$14
		IN10.12CTF48-UD	10.125"	48"	\$120	+\$9	+\$21	—	+\$38	—	+\$92	—	+\$14
		IN10.12CTF54-UD	10.125"	54"	\$121	+\$10	+\$23	—	+\$42	—	+\$98	—	+\$16
		IN10.12CTF60-UD	10.125"	60"	\$132	+\$3	+\$12	—	+\$34	—	+\$91	—	+\$16

Left blank intentionally.

bench

Technology

General information

Inscape Bench electrical is UL and CSA approved. New York City and Chicago solutions are also available as standard offering. The electrical system features 8 wires and 4 circuits that can be configured in a 2+2 or 3+1 circuit configuration. All electrical components, with the exception of the power feed (which must be connected to the building power supply by a licensed electrician) may be installed by furniture installers, unless otherwise stated by jurisdiction of the installation.

Inscape Bench electrical components consist of the following: Floor/Wall power in-feed, power tracks, jumper cables and duplex receptacles. Power components snap into place without the need of tools and are the same components as offered in Inscape System.

Power In-Feed

Power In-Feed connections can be made through a wall, column, or floor connection. Power in-feed connections for Full Height applications consist of an 84" long liquid tight cable and a 45" flex cable connected by a 3" metal coupler and elbow joint to sit between bottom rails. Power in-feed connections for Partial Height applications consist of an 84" long liquid tight cable and a 12" flex cable connected by a 3" metal coupler and elbow joint to sit between bottom rails. The liquid tight portion of the Power in-feed must be connected to the building power supply by an electrician. If two power feeds are being specified for one cluster of stations, care must be taken not to cross connect the two feeds through jumper cables and power tracks.

Two versions of the power in-feed exist. One version is to be used with the Full Height Spine and the other is to be used with the Partial height or Storage Spine and includes a wire casing.

Standing Height Power In-feed kit

Standing Height Power In-feed kit is specified when power is required in a fixed standing height table. This power track is same as noted above however its length allows for seamless entry from floor/wall to the spine.

New York City In-Feed

New York City has requirements for special power entry assemblies. A qualified electrician is required to hard-wire the New York City In-Feed from the entry box to the power source. The New York City feed works for side feed, end feed or ceiling feed.

City of Chicago Hold Down Bracket

The City of Chicago does not permit the use of pre-wired modular electrical systems. To simplify hardwiring of the Inscape Bench Spine, the City of Chicago Hold Down Bracket (INECHB) is available. Specify two INECHB for each power entry point, one for the power feed and one for the outlet. (The outlet box is NOT supplied by Inscape). INECHB's are available in packages of 6.

Boxes should be sourced through Ental Industries or J&A Sheet both local Chicago suppliers of electrical junction boxes.

Note: Spines 30" wide will accept one double-sided outlet box. Spines 36" wide and wider will accept two boxes. INECHB's may also be specified to mount multi-user termination boxes inside the panel.

Power Pole

The Bench power pole brings power and data into the station from the ceiling. It includes a split top trim to facilitate cable entry into the spine panel, a ceiling grommet, an optional 16' or 22' long electrical cable and an expandable power pole featuring a septum to separate power from data cables to avoid electromagnetic interference (EMI). Specify ceiling power pole according to panel width. The ceiling power entry cable must be connected to the building power supply by an electrician. If two power feeds are being specified for one cluster of stations, care must be taken not to cross connect the two feeds through jumper cables and power tracks. The entire power pole accommodates 61 Cat6 and 78 Cat5 cables at a 60% fill capacity if no electrical cable is routed through pole. If electrical is routed within power pole, at a 60% fill capacity, 46 Cat6 and 59 Cat5 cables may be accommodated.

2 + 2 Circuit configuration

2 + 2 Circuit Configuration

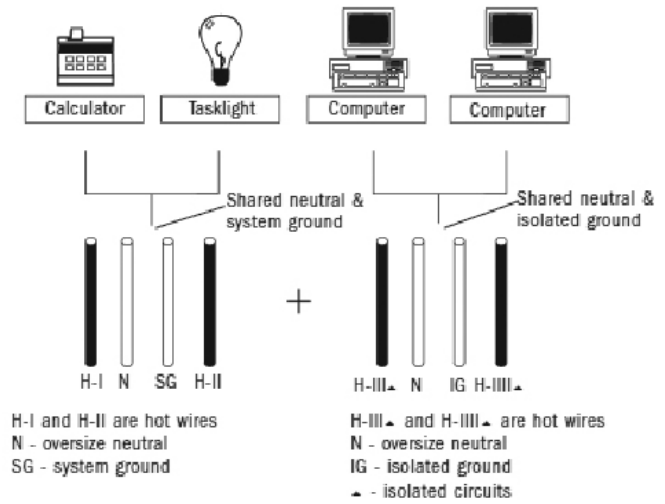

2+2

- Circuits #1 and #2 share one oversized neutral and one shared ground to provide convenience power for task lights, calculators, radios etc.
- Circuits #3 and #4 share the other oversized neutral and isolated ground to provide isolated power to computers.

3+1 Circuit configuration

3 + 1 Circuit Configuration

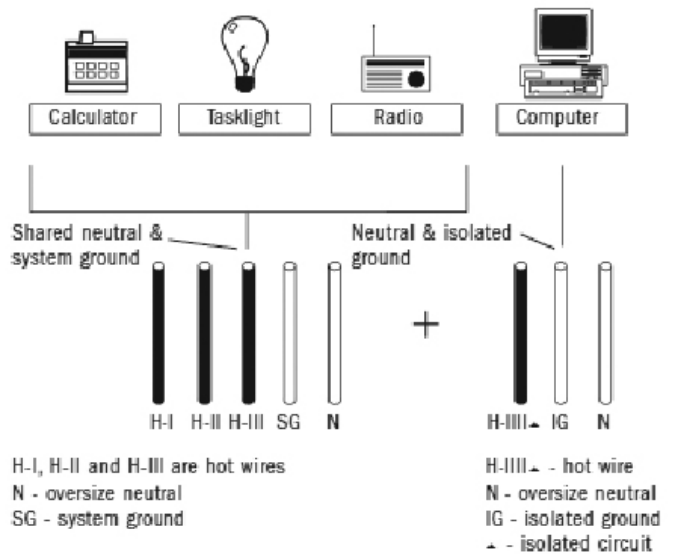

- Circuits #1, #2 and #3 share one oversized neutral and one shared ground to provide convenience power for task lights, calculators, radios etc.
- Circuit #4 uses the other oversized neutral and isolated ground to provide isolated power to computers.

Power track kits

Power Track Kits consist of a power track and clips to attach the power track to a crossrail. The kit allows for power tracks to be mounted in specified locations (above or below the worksurface). Jumper cables and receptacles are specified separately. The 30" wide Power Track Kit accepts one duplex per side. Power Track Kits which are 36" wide and wider accept two duplexes per side. Power Track Kits may be specified below the following; Transaction Tops, Up mount Bins, Stack on Glaze, Add on Glaze and Double Glazed Tiles. Power Track Kits MAY NOT be specified below Twin Bins or Power Poles.

Jumper Cables

Jumper Cables by-pass non-powered spines and also facilitates connections from power track to power track. Jumper cables must attach to power tracks only and cannot be attached to adjacent jumper cables or power in-feeds. Product codes indicate the width of the jumper cable which may be cross-referenced in the Inscape Bench Application Guide. Various widths of jumper cables are available to facilitate various applications and configurations. See Inscape Bench Application Guide for details.

Duplex Receptacles

Duplex Receptacles snap into power tracks back-to-back and may be accessed through cutouts in either the electrical cover plate with standard frames or multi-access and communication tiles in all other locations and basic frames. Duplexes are interchangeable amongst the varying power track locations. Specify duplexes according to circuit configuration, 2+2 or 3+1. The IN2D3_ duplex is specific to 2+2 wire configurations and the IN2DU3_ duplex is specified for 3+1 wire configurations. General rule is no more than 12 receptacles per circuit per power in feed. Duplexes may be specified in black, white (close match to P168 – Glacier White) and gray (close match to P290 – Aluminum Leaf).

Controlled receptacles to satisfy California Title 24 are available. These receptacles control circuits through building switches. When circuits are controlled through building switches, it is required to identify which circuit is controlled to the end user. To identify the receptacles on the controlled circuit, Inscape's controlled receptacles have a power mark (circle with the vertical line). The fit and function of these receptacles are same as the standard receptacle offering only application is in controlled circuits.

Data components

Hinged cover (INHRC)

The hinged cover (INHRC) snaps into the cut outs which are found in multi access and communication tiles. When data faceplates and receptacles are not required the hinged cover provides a visual and protective cover.

Fiber optic outlet

Fiber optic outlet (INCF0) is specified to be installed in a cut out in a multi access or communication tile. May be specified in black, white (close match to P168 – Glacier White) and gray (close match to P290 – Aluminum Leaf).

Data and communication faceplate

The **Data and Communication Faceplate (INCDP)** installs in a cut out in a multi access or communication tile where plug and play access is required. The faceplate provides three "slots" where the **Category 5 (INCABRJ45)**, **Category 6 (INCABR6J45)**, and/or **Telephone Jacks (INCRJ11)** may be inserted. All "openings" need to be filled with data or phone jacks, the **Blank Data Plate Insert (INCB)** fills in any which are not being used. Data components may be specified in black, white (close match to P168 – Glacier White) and gray (close match to P290 – Aluminum Leaf). Telephone Jacks (INCRJ11) are not available in gray.

Clamp on power

Clamp-on power may be clamped along edge of worksurface for plug and play access to electrical/voice/data. Unit has clear anodized aluminum case with white inserts. Different insert configurations available. Voice and data adapter kits are included. Voice and data jacks must be purchased separately. Clamp-on power module has 72" long extension cord. This module adjusts from .75 to 1.75" for varying surface thickness.

Cable Hooks

Cable Hooks support and segregate data cables. Each frame 37" and higher ships with one cable manager. Cable hooks carry data cables to their termination voice/data point at a multi access or communication tile for plug and play access or to hanger brackets which are located behind the tile.

Wire management clips



Wire Management Clips are required when power is being routed from a Credenza Storage benching application frame to the worksurface. Where cabling is running from behind a Credenza Storage case, these wire management clips are mounted to the underside of the inside of the case and the wires are cleanly routed to the main surface. These clips come in a package of 10 and are white in color.

Wire casing

Wire casing manages cables and technology from a worksurface to the floor. Casing is 29" long but can be adjustable in length by removing or adding "links". Casing is available in gray. As standard the wire casing accommodates 28.5"h worksurface heights. The wire casing accommodates 30 Cat5 cables with electrical works at a 60% fill capacity which is recommended. Approximately 36 Cat5 cables may be accommodated in the wire casing at a 60% fill capacity without electrical works.

General information

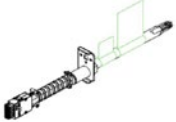
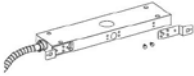
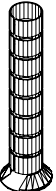
- Partial Height In Feed Kit is slightly shorter than the Full Height Kit and includes wire management casing
- All electrical components are standard 8 wire configuration
- New York City Power In Feed Kit is for use with a full height spine. To use it with Partial Height, Storage or Standing Height spine application, a wire management casing (INBFWC) needs to be specified
- Standing Height Power In Feed Kit includes in-feed and wire management casing
- The power pole is expandable and comes standard with a 16' whip. It also has the option of no power or can accommodate a 22' whip

Description	Part number	List price
 <p>Standard Floor/Wall Power In Feed Kits</p>	INEFWK-8 (use with full spine)	\$314
	INBFWK-8 (use with partial height spine)	\$558
 <p>New York City Power In Feed Kit</p>	INEFWK-NY-8	\$558
 <p>Standing Height Power In Feed Kit</p>	INBSHFWK-8	\$558
 <p>Wire Management Casing Gray</p>	INBFWC	\$112

Description	Part number	Accent paint/ base price	Optional 22" whip	No power option	Accent paint option
 <p>Power Pole</p>	INBPWRPOLE-8	\$1391	+\$195	-\$206	+\$143



General information

- All electrical components are standard 8 wire configuration
- See Inscape System Application Guide for jumper cable length requirements for varying panel configurations
- Jumper Cables do not connect together nor do they attach to power in feeds
- Circuit 3 receptacle requires 2+2 or 3+1 wire designation ("U" in the code signifies 3+1 wire configuration)
- White is a close match to 168 Glacier White, Gray is a close match to 290 Aluminum Leaf
- The "UD" duplexes are to be specified in conjunction with the Electrified Twin Bin (Inscape System Price List)
- Controlled receptacles satisfy California Title 24 and are indicated with a "power mark" which is represented buy a circle with a line

Notes

- Power tracks are required to match the width of the frame they are being installed in
 - Power Track Kits may be specified below the following; Transaction Tops, Up mount Bins, Stack on Glaze, Add on Glaze and Double Glazed Tiles
 - Power Track Kits MAY NOT be specified below Twin Bins or Power Poles
- In order to get a total cost on products when upcharges are present take the list price of the product number and add the upcharge cost shown to the list price.

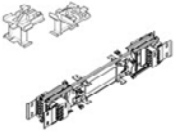
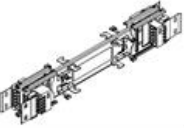
For example:
Product IN2D1-8 in Gray would be +\$23 +\$8

Description	Part number	Width	List price
 Power Track Kit	INRUDKIT-30-8	30"	\$161
	INRUDKIT-36-8	36"	\$174
	INRUDKIT-42-8	42"	\$190
	INRUDKIT-48-8	48"	\$206
	INRUDKIT-54-8	54"	\$220
	INRUDKIT-60-8	60"	\$236
 Electrified Twin-Bin Power Track	INETPTWB-8	8"	\$75
 Jumper Cables	INETC24-8	24"	\$62
	INETC25-8	25"	\$62
	INETC28-8	28"	\$62
	INETC31-8	31"	\$64
	INETC44-8	44"	\$67
	INETC53-8	53"	\$75
	INETC64-8	64"	\$90
	INETC88-8	88"	\$117
	INETC104-8	104"	\$134
	INETC122-8	122"	\$166
	INETC141-8	141"	\$167
	INETC158-8	158"	\$184
INETC182-8	182"	\$211	

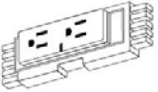
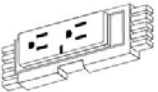
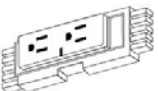
Description	Part number	Black	White	Gray
 Receptacle for cutout tiles application in 2 3/4" frames	IN2D1-8	\$23	+\$8	+\$8
	IN2D2-8	\$23	+\$8	+\$8
	IN2D3-8	\$23	+\$8	+\$8
	IN2D3U-8	\$23	+\$8	+\$8
	IN2D4-8	\$23	+\$8	+\$8
 Controlled Receptacle for cutout tiles application in 2 3/4" frames	IN2D1-8C	\$27	+\$8	+\$8
	IN2D2-8C	\$27	+\$8	+\$8
	IN2D3-8C	\$27	+\$8	+\$8
	IN2D3U-8C	\$27	+\$8	+\$8
	IN2D4-8C	\$27	+\$8	+\$8
 Receptacle for use in Electrified Twin-Bin	IN3D1-UD-8	\$23	+\$8	+\$8
	IN3D2-UD-8	\$23	+\$8	+\$8
	IN3D3-UD-8	\$23	+\$8	+\$8
	IN3D3U-UD-8	\$23	+\$8	+\$8
	IN3D4-UD-8	\$23	+\$8	+\$8

General information





- Data components which are face mounted have optional color of black (default), white or gray
- Data cannot be installed directly back to back in a benching spine
- Data components are industry standard sized AMP product

Note

In order to get a total cost on products when upcharges are present take the list price of the product number and add the upcharge cost shown to the list price.



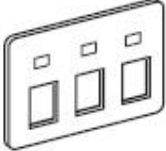

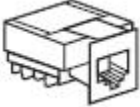
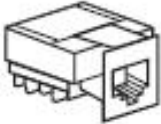
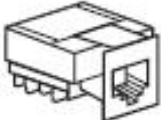

For example:

Product INHRC in Gray would be \$18 +\$8

Description	Part number	Black	White	Gray
 Hinged Cover for Tiles with Cutouts	INHRC	\$18	+\$8	+\$8
 Fiber Optic Outlet	INCFO	\$116	—	—
 Data Communication Plate	INCDP	\$23	+\$6	+\$6
 Blank Data Plate Insert	INCB	\$12	+\$5	+\$5
 Telephone Jack	INCRJ11	\$25	+\$5	—
 Category 5A & 5B, RJ45 Jack	INCABRJ45	\$39	+\$5	+\$5
 Category 6, RJ45 Jack	INC6ABRJ45	\$77	+\$14	+\$14

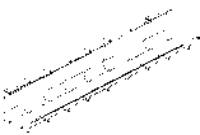
General information

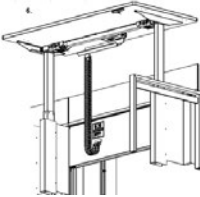
- Wire Management clips are white and attach by double sided tape which is included
- Wire Casing is 29" long and allows for electrical and data cables to neatly be brought from floor into a table – available in gray only, works with 28.5" worksurface heights
- Cable Management tray is available in two lengths, painted Eco Black and includes mounting hardware
- Height Adjustable Cable Manager includes tray and wire sleeve (gray)
- Cable Manager Tray and Hinged Cable Manager Tray include tray and wire sleeve

optionDescription	Part number	List price	Accent paint option
 <p>Wire Management Clip (pkg of 10)</p>	INWMCLIP	\$25	—
 <p>Wire Casing (Gray color)</p>	INFWC	\$112	—
 <p>Cable Management Tray</p>	INCMT18 INCMT30	\$31 \$39	— —
 <p>Wire mesh cable tray (silver)</p>	INWMTRAY	\$115	—
 <p>Height Adjustable Cable Manager</p>	INHACMT18	\$76	—
 <p>18" w Cable Manager Tray For use with Electric Freestanding and Bench (illustrated) height adjustable applications</p>	INHACHCMT18	\$223	+\$23
 <p>Hinged Cable Manager Tray For use with Electric Freestanding and Bench (illustrated) height adjustable applications</p>	INHACMTHINGE	\$463	+\$47



Tables

Accessories

Electrical Accessories

General information

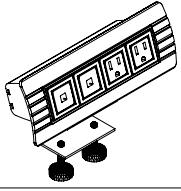
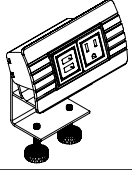
- Clamp on Power Modules have white inserts and a 72" long power cord. It attaches to 1" and 1 ¼" thick worksurfaces

Description		Part number	List price
	Clamp-on Power Module 2 receptacles/2 voice/data ports	PVDMODTC	\$452
	Clamp-on Power Module 1 receptacle/1 dual USB port	PVDMODTC-1P1U	\$488
	Clamp-on Power Module 3 receptacle/1 dual USB port	PVDMODTC-3P1U	\$550

bench

Worksurfaces

Left blank intentionally.

General information

Depth dimension is nominal. Depths are .325" less than stated to provide a gap between the worksurface and panel to facilitate wire management. Worksurfaces are specific to the worksurface support they are being installed on. Codes and dimensions are outlined in the following pages and Inscape Bench Application Guide showing which worksurface is to be specified with the End Gable, Open "H" Leg or Storage Support.

All worksurfaces default to 1.25" thick, Straight edge, Pencil Groove.

Nuform solid & nuform woodgrain/pattern worksurfaces

The Nuform top is a thermo-formable polymer based sheet continuously bonded to a 1.25". The polymer sheet is surface coated with a scratch resistant film. Colors are homogenous throughout the film thickness. Top and edge are one continuous surface with no edge seams. The underside of the top is finished in a low pressure melamine. Nuform tops have the option of a pencil groove running across the width of the worksurface as standard and depth for conference tables. Two price options are available - Nuform Solid and Nuform Woodgrain which includes patterns. Limitations exist with the F06, F08, F09, F10, F11, F16, F26 Nuform due to size of the foil - 48" standard and extended corners as well as 120 degree surfaces.

Edge Detail - Nuform Solid and Nuform Woodgrain

1 1/4" Straight Edge

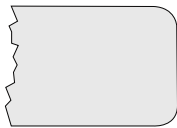

1 1/4" Tapered Edge

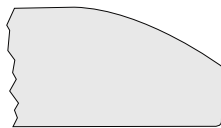

Top and edge are one continuous surface with no edge seams.

Note that the tapered edge style is only available on the front or user edge of the worksurface.

Laminate worksurfaces

Plastic laminate is laminated to 1.25" thick particle-board. The underside of the worksurface is finished with a man-made, wood-fiber veneer backer. Worksurfaces specified with a plastic laminate finish include a 2mm edge banding in a coordinating color. Plastic laminate tops do not include a pencil groove.

Edge Detail - Plastic Laminate

Straight Edge



Composite veneer worksurfaces

Veneer thickness is 0.025". Overall thickness of top is 1.25". The stain color is impregnated throughout the veneer for color consistency. The open pore veneer is clear coated with a catalyzed lacquer utilizing a multi-step process and has a gloss value of 30° when dry. Tops are constructed utilizing 45lbs density particle board with an engineered balanced backer for structural integrity. Tops are edged in 3mm thick same species veneer and do not include a pencil groove.

Edge Detail - Plastic Laminate

Straight Edge



Load capacity for freestanding and panel mounted worksurfaces is 4.5lbs per linear inch.

Grain direction on Nuform Woodgrain and Veneer worksurfaces is as denoted below.

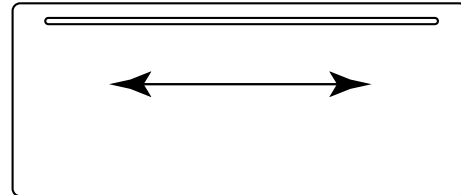

Worksurface extension

The Worksurface Extension is a cantilevered worksurface which is situated perpendicular to the spine. This top is available in all the worksurface finishes of the standard worksurfaces (if woodgrain is chosen, pattern will run perpendicular to the main worksurfaces). This extension CANNOT be specified adjacent to the Height Adjustable Worksurfaces.

Worksurface for electrical access

The Worksurface for Electrical Access is a worksurface which provides easy access to power/data ports below the worksurface within the spine. The hinged access cover is an aluminum component which is inset into the Laminate or Veneer surfaces only. Worksurfaces are specific to the frame width in order to allow the hinged access cover to line up with the port in the spine beneath.

Adjustable height worksurfaces

Panel Mounted Pneumatic and Electrical height adjustable worksurfaces available for the Inscape Bench.

Panel Mounted Pneumatic Height Adjustable Worksurface provide gas cylinder height adjustment ranging from 28.5" to 48.5" with a lift capacity and calibration of a recommended 25lbs (includes worksurface). Electrical Height Adjustable Worksurfaces provide height adjustment ranging from 28.5" to 44.5" with a lift capacity and calibration of a recommended 195lbs (includes worksurface).

Worksurfaces structured on the height adjustable mechanism are 1" less in stated width in the price list, and are meant to be installed on center to the base allowing for a gap between adjacent surfaces to eliminate pinch points. The base mechanism of the worksurface is available in Silver only. See the Inscape Bench Application Guide for application notes and restrictions.

Worksurface support brackets & accessories

Cantilever bracket

Cantilever Bracket is fixed. Cantilever brackets support panel mounted worksurfaces on-module.

Flush brackets

Flush Brackets are specified when two adjoining worksurfaces need to be held flush together. These brackets (INFB) come as a pair. Maximum span of overhang when supported with a flush bracket is 18" per side. These are not required for Height Adjustable worksurfaces.

Spacers

Spacers are specified when storage is being specified within the bench. The appropriate height of storage to use within the bench is 22.5" id with FLAT GLIDE (Rectangular glides will not line up below the worksurface)

Pedestal brackets

Pedestal Brackets are specified when a pedestal unit is being specified. This allows for docking of the storage pieces to the benching spine. End Location Bracket is to be specified when the pedestal is at the end of a run. The Middle Location Bracket is to be specified when a pedestal is situated below the bench within the bench. *See Inscape Bench Application Guide.

Storage docking bracket

Storage Docking Bracket is used when lateral or bookcase units are specified perpendicular to the spine. This bracket docks the storage and worksurface to the spine. *See Inscape Bench Application Guide.

Perpendicular worksurface support brackets

Perpendicular worksurface to spine support brackets support a perpendicular worksurface off of a spine frame. These brackets are handed left or right and there is a double sided option. The handedness of the support bracket is from the user perspective. Brackets are available in all standard paint finishes.

Shared worksurface support brackets

Shared worksurface support brackets are used to support either a 30" d or 36" d shared worksurface off of a spine frame(s) and are available in on module and mid module applications. See Inscape Bench Application Guide for application guidelines. Brackets are available in all standard paint finishes

Angled wood support leg

The angled wood fixed worksurface support leg supports the end of a perpendicular or shared worksurface that is not bracketed to the spine frames. The angled wood fixed worksurface support leg come in two finish options; Clear Maple and Black.

Lateral tops

The Lateral Tops are available as ¾" thick. These tops are to be specified atop the 22.5" id storage units, FLAT GLIDE only on storage. Tops are available in all standard Nuform finishes.

End support

There are three main ways to support the Inscape Bench from an end support perspective. One option is a Full End Gable. This end gable unit spans the entire depth of the bench beneath the worksurfaces, which are specific to this support type. The End Gable is a fully kitted product code which includes trim, tiles, glides and structure. The trim can be painted in any standard paint color. Tiles are to be specified on the inside and outside of the end gable. Tiles on the interior consist of two separate tiles whereas the outside is one full tile. Woodgrain on the exterior tile will run vertical on the tile. The Full End Gable is only to be used with the Full Height Spine.

An alternative support is the Open End Leg which is available in the "H" and "O" options. This open leg structure has the ability to span the entire depth of the bench as well as carry multiple storage/accessories components. These units may be found in the Accessories section and are specific to the Open End Leg. The Open End Leg is only to be used with the Partial Height Spine; unless the Height Adjustable version is being used.

Open O legs have the option to add a glazed insert to either the double or single sided applications. The inserts is glass and is available in clear, gray and etched 1 side finish options.

H Leg hole covers are available for use with H Legs that have been optioned for electric height adjustable worksurfaces as hole are visible. These covers are a small flat rectangular powder coated (any color) sheet steel part that has double sided tape attached and will ship 4 per pack.

Both support types have a mid-span support which matches the overall end aesthetic. These are available in 12" and 18" d. The 12" version is to be specified with 24" and 30" deep worksurfaces and the 18" d with 36" d worksurfaces. Tiles on the Full Gable version are painted only.

When the Height Adjustable Worksurface is specified, either the Full End Gable or the Open End Leg which is specific to the Height Adjustable may be specified. See Inscape Bench Application Guide for more details.

Single sided bench

Single Sided Bench may be specified to create single sided bench configuration. This application may only be used with a full height spine only. End Gable or Open End Legs are end support options. The legs include supports to tie into the spine or worksurface. Mid Supports, whether Full Gable or Open End Legs must be specified between two worksurfaces and tie into the spine on module. Use 18" mid support for 24" d worksurface and 24" mid support for 30" d worksurface. Benching worksurfaces are to be specified in the same way for single sided version of the bench. 36" d worksurfaces are not available in single sided version. When tiling full height tiles are to be specified. Nuform, laminate and veneer tiles cannot be used on single sided frames with electrical. When integrating height adjustable in a single sided application, specific end supports must be specified. The Single Sided Frame to Worksurface bracket must be specified to tie the worksurface into the spine.

Standing height fixed bench

Standing Height Fixed Bench is a fixed version of the bench which sits at a standing height. The Full Height Spine utilizes the Full Height tiles. The Standing Height Mid Spine Support it be specified at each location where two panels meet inline. This support is 13" h and provides the overall height to the spine. Specific Standing Height "H" Legs are specified to be used with the Standing Height Spine. Worksurfaces are specified same as a regular height bench and only 24" and 30" d versions are available. If the desire is to have a full worksurface appearance on the top, a Top Filler Cap may be specified. This cap mounts on the top of the spine and must be specified similar to a worksurface with location of end or middle being called out to ensure proper length and overhang.







General information

- Worksurfaces are to be specified with any Inscape Bench spine in a middle or non-end position
- Nuform, Laminate & Veneer
- Straight & Tapered edge available on Nuform
- 84" and 96" worksurfaces require same support as two surfaces
- Stretcher bars are required to be specified with worksurfaces 54" and wider which do have any mid support
- Stretcher bars are also required for all 30" or deeper worksurfaces no matter the width including when mid cantilever is installed
- Be sure stretcher bars do not to interfere with support brackets, cable trays or other work tools
- Stretcher bars not required for Height Adjustable worksurfaces

Notes

In order to get a total cost on products when upcharges are present take the list price of the product number and add the upcharge cost shown to the list price.

**For example:
 Product INBW2442 in Nuform Woodgrain with Tapered Edge would be \$328 +\$34 +\$17**

Description	Part number	Width	Depth	Nuform/ laminated/ base	Nuform woodgrain/ pattern	Nuform tapered	Grade 1 laminated	Grade 2 laminated	Veneer straight
 24" D Rectangular Top Middle Application	INBW2442	42"	24"	\$328	+\$34	+\$17	+\$105	+\$309	+\$617
	INBW2448	48"	24"	\$376	+\$39	+\$19	+\$121	+\$315	+\$628
	INBW2454	54"	24"	\$422	+\$45	+\$24	+\$136	+\$320	+\$638
	INBW2460	60"	24"	\$468	+\$48	+\$26	+\$150	+\$332	+\$663
	INBW2472	72"	24"	\$563	+\$58	+\$29	+\$181	+\$334	+\$666
	INBW2484	84"	24"	\$658	+\$67	+\$32	+\$211	+\$342	+\$682
	INBW2496	96"	24"	\$755	+\$77	+\$38	+\$242	+\$347	+\$693
 30" D Rectangular Top Middle Application	INBW3042	42"	30"	\$411	+\$43	+\$23	+\$132	+\$352	+\$703
	INBW3048	48"	30"	\$468	+\$48	+\$26	+\$150	+\$355	+\$708
	INBW3054	54"	30"	\$526	+\$54	+\$27	+\$169	+\$359	+\$717
	INBW3060	60"	30"	\$587	+\$60	+\$30	+\$188	+\$362	+\$723
	INBW3072	72"	30"	\$703	+\$72	+\$34	+\$225	+\$370	+\$737
	INBW3084	84"	30"	\$854	+\$88	+\$44	+\$274	+\$346	+\$691
	INBW3096	96"	30"	\$1007	+\$103	+\$51	+\$323	+\$329	+\$656
 36" D Rectangular Top Middle Application	INBW3642	42"	36"	\$477	+\$48	+\$73	+\$153	+\$409	+\$816
	INBW3648	48"	36"	\$541	+\$57	+\$83	+\$174	+\$423	+\$843
	INBW3654	54"	36"	\$609	+\$63	+\$91	+\$195	+\$428	+\$853
	INBW3660	60"	36"	\$682	+\$71	+\$101	+\$219	+\$453	+\$905
	INBW3672	72"	36"	\$814	+\$81	+\$111	+\$261	+\$466	+\$931
 24" D Rectangular Top Middle Application, between one height adjustable and one fixed surface	INBW2441.5	41.5"	24"	\$328	+\$34	+\$17	+\$105	+\$309	+\$617
	INBW2447.5	47.5"	24"	\$376	+\$39	+\$19	+\$121	+\$315	+\$628
	INBW2453.5	53.5"	24"	\$422	+\$45	+\$24	+\$136	+\$320	+\$638
	INBW2459.5	59.5"	24"	\$468	+\$48	+\$26	+\$150	+\$332	+\$663
	INBW2471.5	71.5"	24"	\$563	+\$58	+\$29	+\$181	+\$334	+\$666
	INBW2483.5	83.5"	24"	\$658	+\$67	+\$32	+\$211	+\$342	+\$682
	INBW2495.5	95.5"	24"	\$755	+\$77	+\$38	+\$242	+\$347	+\$693
 30" D Rectangular Top Middle Application, between one height adjustable and one fixed surface	INBW3041.5	41.5"	30"	\$411	+\$43	+\$23	+\$132	+\$352	+\$703
	INBW3047.5	47.5"	30"	\$468	+\$48	+\$26	+\$150	+\$355	+\$708
	INBW3053.5	53.5"	30"	\$526	+\$54	+\$27	+\$169	+\$359	+\$717
	INBW3059.5	59.5"	30"	\$587	+\$60	+\$30	+\$188	+\$362	+\$723
	INBW3071.5	71.5"	30"	\$703	+\$72	+\$34	+\$225	+\$370	+\$737
	INBW3083.5	83.5"	30"	\$854	+\$88	+\$44	+\$274	+\$346	+\$691
	INBW3095.5	95.5"	30"	\$1007	+\$103	+\$51	+\$323	+\$329	+\$656
 24" D Rectangular Top Middle Application, between two height adjustable surfaces	INBW2441	41"	24"	\$328	+\$25	+\$17	+\$105	+\$309	+\$617
	INBW2447	47"	24"	\$376	+\$39	+\$19	+\$121	+\$315	+\$628
	INBW2453	53"	24"	\$422	+\$45	+\$24	+\$136	+\$320	+\$638
	INBW2459	59"	24"	\$468	+\$48	+\$26	+\$150	+\$332	+\$663
	INBW2471	71"	24"	\$563	+\$58	+\$29	+\$181	+\$334	+\$666
	INBW2483	83"	24"	\$658	+\$67	+\$32	+\$211	+\$342	+\$682
	INBW2495	95"	24"	\$755	+\$77	+\$38	+\$242	+\$347	+\$693
 30" D Rectangular Top Middle Application, between two height adjustable surfaces	INBW3041	41"	30"	\$411	+\$43	+\$23	+\$132	+\$352	+\$703
	INBW3047	47"	30"	\$468	+\$48	+\$26	+\$150	+\$355	+\$708
	INBW3053	53"	30"	\$526	+\$54	+\$27	+\$169	+\$359	+\$717
	INBW3059	59"	30"	\$587	+\$60	+\$30	+\$188	+\$362	+\$723
	INBW3071	71"	30"	\$703	+\$72	+\$34	+\$225	+\$370	+\$737
	INBW3083	83"	30"	\$854	+\$88	+\$44	+\$274	+\$346	+\$691
	INBW3095	95"	30"	\$1007	+\$103	+\$51	+\$323	+\$329	+\$656

Worksurfaces

Rectangular Tops

Full End Gable Application

General information





- Worksurfaces are to be specified with End Gable end support
- Nuform, Laminate & Veneer
- Straight & Tapered edge available on Nuform
- 84" and 96" worksurfaces require same support as two surfaces
- Stretcher bars are required to be specified with worksurfaces 54" and wider which do have any mid support
- Stretcher bars are also required for all 30" or deeper worksurfaces no matter the width including when mid cantilever is installed
- Be sure stretcher bars do not to interfere with support brackets, cable trays or other work tools
- Stretcher bars not required for Height Adjustable worksurfaces

Notes

In order to get a total cost on products when upcharges are present take the list price of the product number and add the upcharge cost shown to the list price.

For example:

Product INBWE2442 in Nuform Woodgrain with Tapered Edge would be \$343 +\$36 +\$18

Description	Part number	Width	Depth	Nuform/ laminated/ base	Nuform woodgrain/ pattern	Nuform tapered	Grade 1 laminated	Grade 2 laminated	Veneer straight
	24" D Rectangular Top	44.75"	24"	\$343	+\$36	+\$18	+\$110	+\$324	+\$647
	Full End Gable	50.75"	24"	\$393	+\$42	+\$21	+\$126	+\$330	+\$658
	Application	56.75"	24"	\$443	+\$47	+\$25	+\$142	+\$335	+\$668
		62.75"	24"	\$492	+\$50	+\$27	+\$158	+\$349	+\$697
		74.75"	24"	\$592	+\$61	+\$30	+\$190	+\$351	+\$700
		86.75"	24"	\$692	+\$72	+\$33	+\$222	+\$359	+\$716
	INBWE2496	98.75"	24"	\$793	+\$80	+\$40	+\$254	+\$365	+\$728
	30" D Rectangular Top	44.75"	30"	\$431	+\$45	+\$24	+\$138	+\$370	+\$738
	Full End Gable	50.75"	30"	\$492	+\$50	+\$27	+\$158	+\$373	+\$744
	Application	56.75"	30"	\$552	+\$57	+\$28	+\$177	+\$378	+\$754
		62.75"	30"	\$616	+\$63	+\$31	+\$198	+\$380	+\$758
		74.75"	30"	\$738	+\$75	+\$36	+\$237	+\$388	+\$774
		INBWE3084	86.75"	30"	\$898	+\$92	+\$46	+\$288	+\$363
	INBWE3096	98.75"	30"	\$1056	+\$109	+\$54	+\$338	+\$346	+\$691
	36" D Rectangular Top	44.75"	36"	\$499	+\$50	+\$76	+\$160	+\$430	+\$857
	Full End Gable	50.75"	36"	\$569	+\$60	+\$87	+\$183	+\$443	+\$886
	Application	56.75"	36"	\$640	+\$66	+\$97	+\$205	+\$448	+\$895
		62.75"	36"	\$715	+\$74	+\$107	+\$229	+\$477	+\$951
	INBWE3672	74.75"	36"	\$854	+\$85	+\$116	+\$274	+\$490	+\$977
	24" D Rectangular Top	44.25"	24"	\$343	+\$36	+\$18	+\$110	+\$324	+\$647
	Full End Gable	50.25"	24"	\$393	+\$42	+\$21	+\$126	+\$330	+\$658
	Application, beside	56.25"	24"	\$443	+\$47	+\$25	+\$142	+\$335	+\$668
	one height adjustable	62.25"	24"	\$492	+\$50	+\$27	+\$158	+\$349	+\$697
	surface	74.25"	24"	\$592	+\$61	+\$30	+\$190	+\$351	+\$700
		INBWE2486.25	86.25"	24"	\$692	+\$72	+\$33	+\$222	+\$359
	INBWE2498.25	98.25"	24"	\$793	+\$80	+\$40	+\$254	+\$365	+\$728
	30" D Rectangular Top	44.25"	30"	\$431	+\$45	+\$24	+\$138	+\$370	+\$738
	Full End Gable	50.25"	30"	\$492	+\$50	+\$27	+\$158	+\$373	+\$744
	Application, beside	56.25"	30"	\$552	+\$57	+\$28	+\$177	+\$378	+\$754
	one height adjustable	62.25"	30"	\$616	+\$63	+\$31	+\$198	+\$380	+\$758
	surface	74.25"	30"	\$738	+\$75	+\$36	+\$237	+\$388	+\$774
		INBWE3086.25	86.25"	30"	\$898	+\$92	+\$46	+\$288	+\$363
	INBWE3098.25	98.25"	30"	\$1056	+\$109	+\$54	+\$338	+\$346	+\$691





General information

- Worksurfaces are to be specified with Open End Leg end support
- Nuform, Laminate & Veneer
- Straight & Tapered edge available on Nuform
- 84" and 96" worksurfaces require same support as two surfaces
- Stretcher bars are required to be specified with worksurfaces 54" and wider which do have any mid support
- Stretcher bars are also required for all 30" or deeper worksurfaces no matter the width including when mid cantilever is installed
- Be sure stretcher bars do not to interfere with support brackets, cable trays or other work tools
- Stretcher bars not required for Height Adjustable worksurfaces

Notes

In order to get a total cost on products when upcharges are present take the list price of the product number and add the upcharge cost shown to the list price.

**For example:
 Product INBWO2442 in Nuform Woodgrain with Tapered Edge would be \$343 +\$36 +\$18**

Description	Part number	Width	Depth	Nuform/ laminated/ base	Nuform woodgrain/ pattern	Nuform tapered	Grade 1 laminated	Grade 2 laminated	Veneer straight
 24" D Rectangular Top Open End Leg Application	INBWO2442	44.036"	24"	\$343	+\$36	+\$18	+\$110	+\$324	+\$647
	INBWO2448	50.036"	24"	\$393	+\$42	+\$21	+\$126	+\$330	+\$658
	INBWO2454	56.036"	24"	\$443	+\$47	+\$25	+\$142	+\$335	+\$668
	INBWO2460	62.036"	24"	\$492	+\$50	+\$27	+\$158	+\$349	+\$697
	INBWO2472	74.036"	24"	\$592	+\$61	+\$30	+\$190	+\$351	+\$700
	INBWO2484	86.036"	24"	\$692	+\$72	+\$33	+\$222	+\$359	+\$716
	INBWO2496	98.036"	24"	\$793	+\$80	+\$40	+\$254	+\$365	+\$728
 30" D Rectangular Top Open End Leg Application	INBWO3042	44.036"	30"	\$431	+\$45	+\$24	+\$138	+\$370	+\$738
	INBWO3048	50.036"	30"	\$492	+\$50	+\$27	+\$158	+\$373	+\$744
	INBWO3054	56.036"	30"	\$552	+\$57	+\$28	+\$177	+\$378	+\$754
	INBWO3060	62.036"	30"	\$616	+\$63	+\$31	+\$198	+\$380	+\$758
	INBWO3072	74.036"	30"	\$738	+\$75	+\$36	+\$237	+\$388	+\$774
	INBWO3084	86.036"	30"	\$898	+\$92	+\$46	+\$288	+\$363	+\$724
	INBWO3096	98.036"	30"	\$1056	+\$109	+\$54	+\$338	+\$346	+\$691
 36" D Rectangular Top Open End Leg Application	INBWO3642	44.036"	36"	\$499	+\$50	+\$76	+\$160	+\$430	+\$857
	INBWO3648	50.036"	36"	\$569	+\$60	+\$87	+\$183	+\$443	+\$886
	INBWO3654	56.036"	36"	\$640	+\$66	+\$97	+\$205	+\$448	+\$895
	INBWO3660	62.036"	36"	\$715	+\$74	+\$107	+\$229	+\$477	+\$951
	INBWO3672	74.036"	36"	\$854	+\$85	+\$116	+\$274	+\$490	+\$977
 24" D Rectangular Top Open End Leg Application, beside one height adjustable surface	INBWO2443.53	43.536"	24"	\$343	+\$36	+\$18	+\$110	+\$324	+\$647
	INBWO2449.53	49.536"	24"	\$393	+\$42	+\$21	+\$126	+\$330	+\$658
	INBWO2455.53	55.536"	24"	\$443	+\$47	+\$25	+\$142	+\$335	+\$668
	INBWO2461.53	61.536"	24"	\$492	+\$50	+\$27	+\$158	+\$349	+\$697
	INBWO2473.53	73.536"	24"	\$592	+\$61	+\$30	+\$190	+\$351	+\$700
	INBWO2485.53	85.536"	24"	\$692	+\$72	+\$33	+\$222	+\$359	+\$716
	INBWO2497.53	97.536"	24"	\$793	+\$80	+\$40	+\$254	+\$365	+\$728
 30" D Rectangular Top Open End Leg Application, beside one height adjustable surface	INBWO3043.53	43.536"	30"	\$431	+\$45	+\$24	+\$138	+\$370	+\$738
	INBWO3049.53	49.536"	30"	\$492	+\$50	+\$27	+\$158	+\$373	+\$744
	INBWO3055.53	55.536"	30"	\$552	+\$57	+\$28	+\$177	+\$378	+\$754
	INBWO3061.53	61.536"	30"	\$616	+\$63	+\$31	+\$198	+\$380	+\$758
	INBWO3073.53	73.536"	30"	\$738	+\$75	+\$36	+\$237	+\$388	+\$774
	INBWO3085.53	85.536"	30"	\$898	+\$92	+\$46	+\$288	+\$363	+\$724
	INBWO3097.53	97.536"	30"	\$1056	+\$109	+\$54	+\$338	+\$346	+\$691

Worksurfaces

Rectangular Tops

End Storage Application

General information



- Worksurfaces are to be specified when storage is being used as end support
- Nuform, Laminate & Veneer
- Straight & Tapered edge available on Nuform
- 84" and 96" worksurfaces require same support as two surfaces
- Stretcher bars are required to be specified with worksurfaces 54" and wider which do have any mid support
- Stretcher bars are also required for all 30" or deeper worksurfaces no matter the width including when mid cantilever is installed
- Be sure stretcher bars do not to interfere with support brackets, cable trays or other work tools
- Stretcher bars not required for Height Adjustable worksurfaces

Notes

In order to get a total cost on products when upcharges are present take the list price of the product number and add the upcharge cost shown to the list price.

For example:

Product INBWF2442 in Nuform Woodgrain with Tapered Edge would be \$343 +\$36 +\$18

Description	Part number	Width	Depth	Nuform/ laminite/ base	Nuform woodgrain/ pattern	Nuform tapered	Grade 1 laminite	Grade 2 laminite	Veneer straight	
	24" D Rectangular Top	42.3"	24"	\$343	+\$36	+\$18	+\$110	+\$324	+\$647	
	End Storage	INBWF2442	48.3"	24"	\$393	+\$42	+\$21	+\$126	+\$330	+\$658
	Application	INBWF2454	54.3"	24"	\$443	+\$47	+\$25	+\$142	+\$335	+\$668
		INBWF2460	60.3"	24"	\$492	+\$50	+\$27	+\$158	+\$349	+\$697
		INBWF2472	72.3"	24"	\$592	+\$61	+\$30	+\$190	+\$351	+\$700
		INBWF2484	84.3"	24"	\$692	+\$72	+\$33	+\$222	+\$359	+\$716
	INBWF2496	96.3"	24"	\$793	+\$80	+\$40	+\$254	+\$365	+\$728	
	30" D Rectangular Top	42.3"	30"	\$431	+\$45	+\$24	+\$138	+\$370	+\$738	
	End Storage	INBWF3042	48.3"	30"	\$492	+\$50	+\$27	+\$158	+\$373	+\$744
	Application	INBWF3054	54.3"	30"	\$552	+\$57	+\$28	+\$177	+\$378	+\$754
		INBWF3060	60.3"	30"	\$616	+\$63	+\$31	+\$198	+\$380	+\$758
		INBWF3072	72.3"	30"	\$738	+\$75	+\$36	+\$237	+\$388	+\$774
		INBWF3084	84.3"	30"	\$898	+\$92	+\$46	+\$288	+\$363	+\$724
	INBWF3096	96.3"	30"	\$1056	+\$109	+\$54	+\$338	+\$346	+\$691	
	36" D Rectangular Top	42.3"	36"	\$499	+\$50	+\$76	+\$160	+\$430	+\$857	
	End Storage	INBWF3642	48.3"	36"	\$569	+\$60	+\$87	+\$183	+\$443	+\$886
	Application	INBWF3654	54.3"	36"	\$640	+\$66	+\$97	+\$205	+\$448	+\$895
		INBWF3660	60.3"	36"	\$715	+\$74	+\$107	+\$229	+\$477	+\$951
		INBWF3672	72.3"	36"	\$854	+\$85	+\$116	+\$274	+\$490	+\$977

General information

- Worksurfaces are to be specified with any Inscape Bench spine in a middle or non-end position
- Laminate & Veneer only - Nuform not available
- 84" and 96" worksurfaces require same support as two surfaces
- See Inscape Bench Application Guide for cut-out placement and quantities on various widths
- Stretcher bars are required to be specified with worksurfaces 54" and wider which do have any mid support
- Stretcher bars are also required for all 30" or deeper worksurfaces no matter the width including when mid cantilever is installed
- Be sure stretcher bars do not to interfere with support brackets, cable trays or other work tools
- Stretcher bars not required for Height Adjustable worksurfaces

Notes

In order to get a total cost on products when upcharges are present take the list price of the product number and add the upcharge cost shown to the list price.

For example:

Product INBWEA2448 in Veneer would be \$750 +\$1255

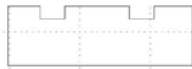
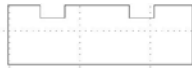
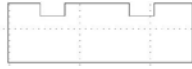
Description	Part number	Width	Depth	Laminate/ base	Grade 1 laminate	Grade 2 laminate	Veneer
 24" D Rectangular Electrical Access Worksurface Middle Application	INBWEA2448	48"	24"	\$750	+\$240	+\$629	+\$1255
	INBWEA2454	54"	24"	\$843	+\$270	+\$638	+\$1273
	INBWEA2460	60"	24"	\$936	+\$300	+\$663	+\$1325
	INBWEA2472	72"	24"	\$1125	+\$360	+\$666	+\$1331
	INBWEA2484	84"	24"	\$1318	+\$422	+\$683	+\$1364
	INBWEA2496	96"	24"	\$1511	+\$484	+\$692	+\$1382
 30" D Rectangular Electrical Access Worksurface Middle Application	INBWEA3048	48"	30"	\$936	+\$300	+\$709	+\$1416
	INBWEA3054	54"	30"	\$1051	+\$337	+\$717	+\$1434
	INBWEA3060	60"	30"	\$1173	+\$376	+\$723	+\$1445
	INBWEA3072	72"	30"	\$1404	+\$450	+\$738	+\$1474
	INBWEA3084	84"	30"	\$1706	+\$546	+\$690	+\$1378
	INBWEA3096	96"	30"	\$2011	+\$644	+\$656	+\$1312
 36" D Rectangular Electrical Access Worksurface Middle Application	INBWEA3648	48"	36"	\$1136	+\$364	+\$817	+\$1632
	INBWEA3654	54"	36"	\$1279	+\$410	+\$823	+\$1644
	INBWEA3660	60"	36"	\$1429	+\$458	+\$871	+\$1742
	INBWEA3672	72"	36"	\$1706	+\$546	+\$892	+\$1782

Worksurfaces

Electrical Access Worksurface

Full End Gable Application

General information

- Worksurfaces are to be specified when Full End Gable are used as end support
- Laminate & Veneer only - Nuform not available
- 84" and 96" worksurfaces require same support as two surfaces
- See Inscape Bench Application Guide for cut-out placement and quantities on various widths
- Place left hand version if end support is on left side, place right hand version if end support is on right side
- Stretcher bars are required to be specified with worksurfaces 54" and wider which do have any mid support
- Stretcher bars are also required for all 30" or deeper worksurfaces no matter the width including when mid cantilever is installed
- Be sure stretcher bars do not to interfere with support brackets, cable trays or other work tools
- Stretcher bars not required for Height Adjustable worksurfaces

Notes

In order to get a total cost on products when upcharges are present take the list price of the product number and add the upcharge cost shown to the list price.

For example:

Product INBWEAEL2448 in Veneer would be \$788 +\$1318

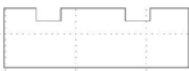
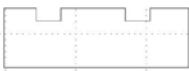
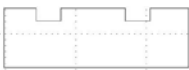
Description	Part number	Width	Depth	Laminate/ base	Grade 1 laminate	Grade 2 laminate	Veneer
 24" D Rectangular Electrical Access Worksurface Full End Gable Application	INBWEAEL2448	50.75"	24"	\$788	+\$253	+\$659	+\$1318
	INBWEAEL2454	56.75"	24"	\$885	+\$284	+\$669	+\$1338
	INBWEAEL2460	62.75"	24"	\$982	+\$315	+\$697	+\$1392
	INBWEAEL2472	74.75"	24"	\$1181	+\$378	+\$700	+\$1398
	INBWEAEL2484	86.75"	24"	\$1383	+\$443	+\$716	+\$1432
	INBWEAEL2496	98.75"	24"	\$1586	+\$508	+\$727	+\$1452
	left-handed						
	INBWEAER2448	50.75"	24"	\$788	+\$253	+\$659	+\$1318
	INBWEAER2454	56.75"	24"	\$885	+\$284	+\$669	+\$1338
	INBWEAER2460	62.75"	24"	\$982	+\$315	+\$697	+\$1392
 30" D Rectangular Electrical Access Worksurface Full End Gable Application	INBWEAEL3048	50.75"	30"	\$982	+\$315	+\$744	+\$1486
	INBWEAEL3054	56.75"	30"	\$1103	+\$353	+\$754	+\$1507
	INBWEAEL3060	62.75"	30"	\$1232	+\$395	+\$759	+\$1517
	INBWEAEL3072	74.75"	30"	\$1474	+\$472	+\$774	+\$1546
	INBWEAEL3084	86.75"	30"	\$1791	+\$574	+\$724	+\$1448
	INBWEAEL3096	98.75"	30"	\$2113	+\$677	+\$690	+\$1377
	left-handed						
	INBWEAER3048	50.75"	30"	\$982	+\$315	+\$744	+\$1486
	INBWEAER3054	56.75"	30"	\$1103	+\$353	+\$754	+\$1507
	INBWEAER3060	62.75"	30"	\$1232	+\$395	+\$759	+\$1517
INBWEAER3072	74.75"	30"	\$1474	+\$472	+\$774	+\$1546	
 36" D Rectangular Electrical Access Worksurface Full End Gable Application	INBWEAEL3648	50.75"	36"	\$1136	+\$364	+\$886	+\$1770
	INBWEAEL3654	56.75"	36"	\$1279	+\$410	+\$896	+\$1789
	INBWEAEL3660	62.75"	36"	\$1429	+\$458	+\$951	+\$1900
	INBWEAEL3672	74.75"	36"	\$1706	+\$546	+\$978	+\$1955
	left-handed						
	INBWEAER3648	50.75"	36"	\$1136	+\$364	+\$886	+\$1770
	INBWEAER3654	56.75"	36"	\$1279	+\$410	+\$896	+\$1789
	INBWEAER3660	62.75"	36"	\$1429	+\$458	+\$951	+\$1900
	INBWEAER3672	74.75"	36"	\$1706	+\$546	+\$978	+\$1955
	right-handed						

General information

- Worksurfaces are to be specified when Open End Legs are used as end support
- Laminate & Veneer only - Nuform not available
- 84" and 96" worksurfaces require same support as two surfaces
- See Inscape Bench Application Guide for cut-out placement and quantities on various widths
- Place left hand version if end support is on left side, place right hand version if end support is on right side
- Stretcher bars are required to be specified with worksurfaces 54" and wider which do have any mid support
- Stretcher bars are also required for all 30" or deeper worksurfaces no matter the width including when mid cantilever is installed
- Be sure stretcher bars do not interfere with support brackets, cable trays or other work tools
- Stretcher bars not required for Height Adjustable worksurfaces

Notes

In order to get a total cost on products when upcharges are present take the list price of the product number and add the upcharge cost shown to the list price.

For example:

Product INBWEAOL2448 in Veneer would be \$788 +\$1318

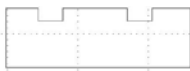
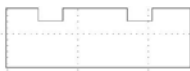
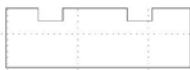
Description	Part number	Width	Depth	Laminate/ base	Grade 1 laminate	Grade 2 laminate	Veneer
 <p>24" D Rectangular Electrical Access Worksurface Open End Leg Application</p>	INBWEAOL2448	50.036"	24"	\$788	+\$253	+\$659	+\$1318
	INBWEAOL2454	56.036"	24"	\$885	+\$284	+\$669	+\$1338
	INBWEAOL2460	62.036"	24"	\$982	+\$315	+\$697	+\$1392
	INBWEAOL2472	74.036"	24"	\$1181	+\$378	+\$700	+\$1398
	INBWEAOL2484	86.036"	24"	\$1383	+\$443	+\$716	+\$1432
	INBWEAOL2496	98.036"	24"	\$1586	+\$508	+\$727	+\$1452
	left-handed						
	INBWEAOR2448	50.036"	24"	\$788	+\$253	+\$659	+\$1318
	INBWEAOR2454	56.036"	24"	\$885	+\$284	+\$669	+\$1338
	INBWEAOR2460	62.036"	24"	\$982	+\$315	+\$697	+\$1392
	INBWEAOR2472	74.036"	24"	\$1181	+\$378	+\$700	+\$1398
	INBWEAOR2484	86.036"	24"	\$1383	+\$443	+\$716	+\$1432
	INBWEAOR2496	98.036"	24"	\$1586	+\$508	+\$727	+\$1452
	right-handed						
 <p>30" D Rectangular Electrical Access Worksurface Open End Leg Application</p>	INBWEAOL3048	50.036"	30"	\$982	+\$315	+\$744	+\$1486
	INBWEAOL3054	56.036"	30"	\$1103	+\$353	+\$754	+\$1507
	INBWEAOL3060	62.036"	30"	\$1232	+\$395	+\$759	+\$1517
	INBWEAOL3072	74.036"	30"	\$1474	+\$472	+\$774	+\$1546
	INBWEAOL3084	86.036"	30"	\$1791	+\$574	+\$724	+\$1448
	INBWEAOL3096	98.036"	30"	\$2113	+\$677	+\$690	+\$1377
	left-handed						
	INBWEAOR3048	50.036"	30"	\$982	+\$315	+\$744	+\$1486
	INBWEAOR3054	56.036"	30"	\$1103	+\$353	+\$754	+\$1507
	INBWEAOR3060	62.036"	30"	\$1232	+\$395	+\$759	+\$1517
	INBWEAOR3072	74.036"	30"	\$1474	+\$472	+\$774	+\$1546
	INBWEAOR3084	86.036"	30"	\$1791	+\$574	+\$724	+\$1448
	INBWEAOR3096	98.036"	30"	\$2113	+\$677	+\$690	+\$1377
	right-handed						
 <p>36" D Rectangular Electrical Access Worksurface Open End Leg Application</p>	INBWEAOL3648	50.036"	36"	\$1136	+\$364	+\$886	+\$1770
	INBWEAOL3654	56.036"	36"	\$1279	+\$410	+\$896	+\$1789
	INBWEAOL3660	62.036"	36"	\$1429	+\$458	+\$951	+\$1900
	INBWEAOL3672	74.036"	36"	\$1706	+\$546	+\$978	+\$1955
	left-handed						
	INBWEAOR3648	50.036"	36"	\$1136	+\$364	+\$886	+\$1770
	INBWEAOR3654	56.036"	36"	\$1279	+\$410	+\$896	+\$1789
	INBWEAOR3660	62.036"	36"	\$1429	+\$458	+\$951	+\$1900
	INBWEAOR3672	74.036"	36"	\$1706	+\$546	+\$978	+\$1955
	right-handed						

Worksurfaces

Perpendicular worksurface

General information



- Rectangular Curved worksurfaces have curved back corners and straight 90° front corners
- Stretcher bars are included with all perpendicular worksurfaces
- The curved rectangular perpendicular worksurface will overhang 4.5" from the spine end line
- The straight rectangular perpendicular worksurfaces will overhang .300" from the spine end line which will bring it flush with the end trim
- The shared worksurface is not available with a tapered edge and freestanding end support legs must be specified separately

Notes

In order to get a total cost on products when upcharges are present take the list price of the product number and add the upcharge cost shown to the list price.

For example:

Product INBWCP2448 in Nuform Woodgrain with Tapered Edge would be \$376 +\$39 +\$19

Description	Part number	Width	Depth	Nuform/ laminates/ base	Nuform woodgrain/ pattern	Nuform tapered	Grade 1 laminates	Grade 2 laminates	
	Curved Rectangular Perpendicular Worksurface with back curved corners	INBWCP2448	48"	24"	\$376	+\$39	+\$19	+\$120	+\$309
		INBWCP2454	54"	24"	\$422	+\$45	+\$24	+\$139	+\$320
		INBWCP2460	60"	24"	\$468	+\$48	+\$26	+\$149	+\$332
		INBWCP3048	48"	30"	\$468	+\$48	+\$26	+\$149	+\$355
		INBWCP3054	54"	30"	\$526	+\$54	+\$27	+\$167	+\$359
		INBWCP3060	60"	30"	\$587	+\$60	+\$30	+\$186	+\$362
	Straight Rectangular Perpendicular Worksurface	INBWSP2448	48"	24"	\$376	+\$39	+\$19	+\$120	+\$315
		INBWSP2454	54"	24"	\$422	+\$45	+\$24	+\$139	+\$320
		INBWSP2460	60"	24"	\$468	+\$48	+\$26	+\$149	+\$332
		INBWSP3048	48"	30"	\$468	+\$48	+\$26	+\$149	+\$355
		INBWSP3054	54"	30"	\$526	+\$54	+\$27	+\$167	+\$359
		INBWSP3060	60"	30"	\$587	+\$60	+\$30	+\$186	+\$362
	Straight Rectangular Shared Worksurface	INBWSHSP3048	48"	30"	\$468	+\$48	—	+\$149	+\$355
		INBWSHSP3054	54"	30"	\$526	+\$54	—	+\$167	+\$359
		INBWSHSP3060	60"	30"	\$587	+\$60	—	+\$186	+\$362
		INBWSHSP3648	48"	36"	\$541	+\$57	—	+\$177	+\$423
		INBWSHSP3654	54"	36"	\$609	+\$63	—	+\$195	+\$428
		INBWSHSP3660	60"	36"	\$682	+\$71	—	+\$218	+\$453

General information

- Worksurfaces are to be specified with any Inscape Bench spine in a middle or non-end position
- 24”d worksurfaces have a front dimension of 38”
- 30”d worksurfaces have a front dimension of 32”
- Specific worksurfaces must be used in specific applications based on location and end support
- Nuform, Laminate & Veneer
- Straight & Tapered edge available on Nuform
- Stretcher bars are required to be specified with worksurfaces 54” and wider which do have any mid support
- Stretcher bars are also required for all 30” or deeper worksurfaces no matter the width including when mid cantilever is installed
- Be sure stretcher bars do not to interfere with support brackets, cable trays or other work tools
- Stretcher bars not required for Height Adjustable worksurfaces

Notes

In order to get a total cost on products when upcharges are present take the list price of the product number and add the upcharge cost shown to the list price.

For example:

Product INBWVM363624 in Veneer would be \$469 +\$1053

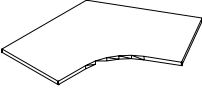
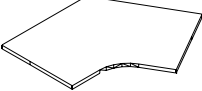
Description	Part number	Width	Depth	Nuform/ laminate	Nuform woodgrain/ pattern	Nuform tapered	Grade 1 laminate	Grade 2 laminate	Veneer straight
 24" D 120° Worksurface Middle Application	INBWVM363624	36"	23"	\$469	+\$46	+\$26	+\$151	+\$527	+\$1053
	INBWVM424224	42"	23"	\$668	+\$67	+\$35	+\$214	+\$592	+\$1183
	INBWVM484824	48"	23"	\$818	+\$83	+\$40	+\$262	+\$698	+\$1394
	INBWVM545424	54"	23"	\$904	—	—	+\$290	—	+\$1728
	INBWVM606024	60"	23"	\$1138	—	—	+\$365	—	+\$2177
 30" D 120° Worksurface Middle Application	INBWVM363630	36"	29"	\$580	+\$58	+\$29	+\$186	+\$555	+\$1109
	INBWVM424230	42"	29"	\$702	+\$71	+\$35	+\$225	+\$671	+\$1341
	INBWVM484830	48"	29"	\$846	—	—	+\$271	—	+\$1616
	INBWVM545430	54"	29"	\$989	—	—	+\$317	—	+\$1887
	INBWVM606030	60"	29"	\$1239	—	—	+\$397	—	+\$2371

Worksurfaces

120° Worksurface

Full End Gable Application

General information

- Worksurfaces are to be specified when Full End Gable are used as end support
- 24”d worksurfaces have a front dimension of 38”
- 30”d worksurfaces have a front dimension of 32”
- Specific worksurfaces must be used in specific applications based on location and end support
- Nuform, Laminate & Veneer
- Straight & Tapered edge available on Nuform
- Stretcher bars are required to be specified with worksurfaces 54” and wider which do have any mid support
- Stretcher bars are also required for all 30” or deeper worksurfaces no matter the width including when mid cantilever is installed
- Be sure stretcher bars do not to interfere with support brackets, cable trays or other work tools
- Stretcher bars not required for Height Adjustable worksurfaces

Notes

In order to get a total cost on products when upcharges are present take the list price of the product number and add the upcharge cost shown to the list price.

For example:

Product INBWLHE363624 in Veneer would be \$493 +\$1124

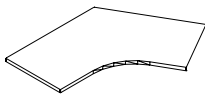
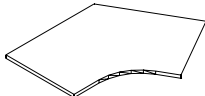
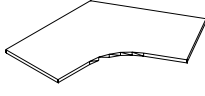
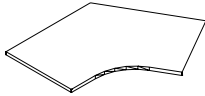
Description	Part number	Width	Depth	Nuform/ laminate	Nuform woodgrain/ pattern	Nuform tapered	Grade 1 laminate	Grade 2 laminate	Veneer straight	
	24" D 120° Worksurface	INBWLHE363624	36"	23"	\$493	+\$49	+\$26	+\$158	+\$563	+\$1124
	Full End Gable	INBWLHE424224	42"	23"	\$702	+\$71	+\$35	+\$225	+\$629	+\$1256
	Application	INBWLHE484824	48"	23"	\$858	+\$85	+\$43	+\$275	+\$734	+\$1467
		INBWLHE545424	54"	23"	\$950	—	—	+\$304	—	+\$1809
		INBWLHE606024	60"	23"	\$1197	—	—	+\$384	—	+\$2268
		left-handed								
		INBWRHE363624	36"	23"	\$493	+\$49	+\$26	+\$158	+\$563	+\$1124
		INBWRHE424224	42"	23"	\$702	+\$71	+\$35	+\$225	+\$629	+\$1256
		INBWRHE484824	48"	23"	\$858	+\$85	+\$43	+\$275	+\$734	+\$1467
		INBWRHE545424	54"	23"	\$950	—	—	+\$304	—	+\$1809
	INBWRHE606024	60"	23"	\$1197	—	—	+\$384	—	+\$2268	
	right-handed									
	30" D 120° Worksurface	INBWLHE363630	36"	29"	\$608	+\$61	+\$31	+\$195	+\$592	+\$1182
	Full End Gable	INBWLHE424230	42"	29"	\$737	+\$74	+\$37	+\$236	+\$710	+\$1418
	Application	INBWLHE484830	48"	29"	\$888	—	—	+\$285	—	+\$1697
		INBWLHE545430	54"	29"	\$1039	—	—	+\$333	—	+\$1970
		INBWLHE606030	60"	29"	\$1302	—	—	+\$417	—	+\$2466
		left-handed								
		INBWRHE363630	36"	29"	\$608	+\$61	+\$31	+\$195	+\$592	+\$1182
		INBWRHE424230	42"	29"	\$737	+\$74	+\$37	+\$236	+\$710	+\$1418
		INBWRHE484830	48"	29"	\$888	—	—	+\$285	—	+\$1697
		INBWRHE545430	54"	29"	\$1039	—	—	+\$333	—	+\$1970
	INBWRHE606030	60"	29"	\$1302	—	—	+\$417	—	+\$2466	
	right-handed									
	24" D 120° Worksurface	INBWVDE363624	36"	23"	\$516	+\$51	+\$27	+\$166	+\$598	+\$1196
	Double Full End	INBWVDE424224	42"	23"	\$735	+\$74	+\$36	+\$236	+\$664	+\$1327
	Gable Application	INBWVDE484824	48"	23"	\$900	+\$89	+\$45	+\$288	+\$771	+\$1541
		INBWVDE545424	54"	23"	\$994	—	—	+\$319	—	+\$1891
		INBWVDE606024	60"	23"	\$1254	—	—	+\$402	—	+\$2361
	30" D 120° Worksurface	INBWVDE363630	36"	29"	\$638	+\$63	+\$32	+\$205	+\$629	+\$1255
	Double Full End	INBWVDE424230	42"	29"	\$772	+\$77	+\$38	+\$248	+\$748	+\$1494
	Gable Application	INBWVDE484830	48"	29"	\$930	—	—	+\$298	—	+\$1777
		INBWVDE545430	54"	29"	\$1088	—	—	+\$349	—	+\$2051
		INBWVDE606030	60"	29"	\$1365	—	—	+\$437	—	+\$2559

General information





- Worksurfaces are to be specified when Open End Legs are used as end support
- 24”d worksurfaces have a front dimension of 38”
- 30”d worksurfaces have a front dimension of 32”
- Specific worksurfaces must be used in specific applications based on location and end support
- Nuform, Laminate & Veneer
- Straight & Tapered edge available on Nuform
- Stretcher bars are required to be specified with worksurfaces 54” and wider which do have any mid support
- Stretcher bars are also required for all 30” or deeper worksurfaces no matter the width including when mid cantilever is installed
- Be sure stretcher bars do not interfere with support brackets, cable trays or other work tools
- Stretcher bars not required for Height Adjustable worksurfaces

Notes

In order to get a total cost on products when upcharges are present take the list price of the product number and add the upcharge cost shown to the list price.

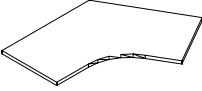
For example:

Product INBWVLHO363624 in Veneer would be \$493 +\$1124

Description	Part number	Width	Depth	Nuform/ laminate	Nuform woodgrain/ pattern	Nuform tapered	Grade 1 laminate	Grade 2 laminate	Veneer straight	
	24" D 120° Worksurface	INBWVLHO363624	36"	23"	\$493	+\$49	+\$25	+\$158	+\$563	+\$1124
	Open End Leg	INBWVLHO424224	42"	23"	\$702	+\$71	+\$35	+\$225	+\$629	+\$1256
	Application	INBWVLHO484824	48"	23"	\$858	+\$85	+\$43	+\$275	+\$734	+\$1467
		INBWVLHO545424	54"	23"	\$950	—	—	+\$304	—	+\$1809
		INBWVLHO606024	60"	23"	\$1197	—	—	+\$384	—	+\$2268
		left-handed								
		INBWRHO363624	36"	23"	\$493	+\$49	+\$26	+\$158	+\$563	+\$1124
		INBWRHO424224	42"	23"	\$702	+\$71	+\$35	+\$225	+\$629	+\$1256
		INBWRHO484824	48"	23"	\$858	+\$85	+\$43	+\$275	+\$734	+\$1467
		INBWRHO545424	54"	23"	\$950	—	—	+\$304	—	+\$1809
	INBWRHO606024	60"	23"	\$1197	—	—	+\$384	—	+\$2268	
	right-handed									
	30" D 120° Worksurface	INBWVLHO363630	36"	29"	\$608	+\$61	+\$31	+\$195	+\$592	+\$1182
	Open End Leg	INBWVLHO424230	42"	29"	\$737	+\$74	+\$37	+\$236	+\$710	+\$1418
	Application	INBWVLHO484830	48"	29"	\$888	—	—	+\$285	—	+\$1697
		INBWVLHO545430	54"	29"	\$1039	—	—	+\$333	—	+\$1970
		INBWVLHO606030	60"	29"	\$1302	—	—	+\$417	—	+\$2466
		left-handed								
		INBWRHO363630	36"	29"	\$608	+\$61	+\$31	+\$195	+\$592	+\$1182
		INBWRHO424230	42"	29"	\$737	+\$74	+\$37	+\$236	+\$710	+\$1418
		INBWRHO484830	48"	29"	\$888	—	—	+\$285	—	+\$1697
		INBWRHO545430	54"	29"	\$1039	—	—	+\$333	—	+\$1970
	INBWRHO606030	60"	29"	\$1302	—	—	+\$417	—	+\$2466	
	right-handed									
	24" D 120° Worksurface	INBWVDO363624	36"	23"	\$516	+\$51	+\$27	+\$166	+\$598	+\$1196
	Double Open End	INBWVDO424224	42"	23"	\$735	+\$74	+\$36	+\$236	+\$664	+\$1327
	Leg Application	INBWVDO484824	48"	23"	\$900	+\$89	+\$45	+\$288	+\$771	+\$1541
		INBWVDO545424	54"	23"	\$994	—	—	+\$319	—	+\$1891
		INBWVDO606024	60"	23"	\$1254	—	—	+\$402	—	+\$2361
	30" D 120° Worksurface	INBWVDO363630	36"	29"	\$638	+\$63	+\$32	+\$205	+\$629	+\$1255
	Double Open End	INBWVDO424230	42"	29"	\$772	+\$77	+\$38	+\$248	+\$748	+\$1494
	Leg Application	INBWVDO484830	48"	29"	\$930	—	—	+\$298	—	+\$1777
		INBWVDO545430	54"	29"	\$1088	—	—	+\$349	—	+\$2051
		INBWVDO606030	60"	29"	\$1365	—	—	+\$437	—	+\$2559

Worksurfaces

Height Adjustable Worksurface Manual Pneumatic

General information

- Specific worksurfaces must be used in specific applications based on location and end support
- This manual pneumatic height adjustable table has a lift capacity of 25lbs (includes worksurface)
- Height adjustment is 28.5" to 48.5"; a total range of 20"
- Base comes in silver only
- Tops are adjustable by a paddle in the front right of the worksurface
- Nuform, Laminate & Veneer
- Straight & Tapered edge available on Nuform
- End units are ½" shorter in length and Middle units are ½" shorter on each end eliminating potential pinch points

- Only to be installed on Full Height Spine option - with either full height end gable or open end leg
- See Inscape Bench Application Guide for more details
- Stretcher bars not required for Height Adjustable worksurfaces

Notes

In order to get a total cost on products when upcharges are present take the list price of the product number and add the upcharge cost shown to the list price.

For example:

Product INBEZ2436 in Veneer would be \$2108 +\$577

Description	Part number	Width	Depth	Nuform/ laminate	Nuform woodgrain/ pattern	Nuform tapered	Grade 1 laminate	Grade 2 laminate	Veneer straight	
	24" D Manual Pneumatic Height Adjustable Worksurface Middle Application	INBEZ2436	35"	23.675"	\$2108	+\$33	+\$16	+\$675	+\$289	+\$577
		INBEZ2442	41"	23.675"	\$2134	+\$34	+\$17	+\$683	+\$309	+\$617
		INBEZ2448	47"	23.675"	\$2181	+\$39	+\$19	+\$698	+\$315	+\$628
		INBEZ2454	53"	23.675"	\$2240	+\$45	+\$24	+\$717	+\$320	+\$638
		INBEZ2460	59"	23.675"	\$2286	+\$48	+\$26	+\$732	+\$332	+\$663
	INBEZ2472	71"	23.675"	\$2721	+\$58	+\$29	+\$871	+\$334	+\$666	
	30" D Manual Pneumatic Height Adjustable Worksurface Middle Application	INBEZ3036	35"	29.675"	\$2185	+\$33	+\$16	+\$700	+\$332	+\$662
		INBEZ3042	41"	29.675"	\$2228	+\$34	+\$17	+\$713	+\$352	+\$703
		INBEZ3048	47"	29.675"	\$2286	+\$39	+\$19	+\$732	+\$355	+\$708
		INBEZ3054	53"	29.675"	\$2580	+\$45	+\$24	+\$826	+\$359	+\$717
		INBEZ3060	59"	29.675"	\$2641	+\$48	+\$26	+\$846	+\$362	+\$723
	INBEZ3072	71"	29.675"	\$2855	+\$58	+\$29	+\$914	+\$370	+\$737	
	24" D Manual Pneumatic Height Adjustable Worksurface Full End Gable Application	INBEZE2436	38.25"	23.675"	\$2108	+\$33	+\$16	+\$675	+\$289	+\$577
		INBEZE2442	44.25"	23.675"	\$2134	+\$34	+\$17	+\$683	+\$309	+\$617
		INBEZE2448	50.25"	23.675"	\$2181	+\$39	+\$19	+\$698	+\$315	+\$628
		INBEZE2454	56.25"	23.675"	\$2240	+\$45	+\$24	+\$717	+\$320	+\$638
		INBEZE2460	62.25"	23.675"	\$2286	+\$48	+\$26	+\$732	+\$332	+\$663
	INBEZE2472	74.75"	23.675"	\$2721	+\$58	+\$29	+\$871	+\$334	+\$666	
	30" D Manual Pneumatic Height Adjustable Worksurface Full End Gable Application	INBEZE3036	38.25"	29.675"	\$2185	+\$33	+\$16	+\$700	+\$332	+\$662
		INBEZE3042	44.25"	29.675"	\$2228	+\$34	+\$17	+\$713	+\$352	+\$703
		INBEZE3048	50.25"	29.675"	\$2286	+\$39	+\$19	+\$732	+\$355	+\$708
		INBEZE3054	56.25"	29.675"	\$2580	+\$45	+\$24	+\$826	+\$359	+\$717
		INBEZE3060	62.25"	29.675"	\$2641	+\$48	+\$26	+\$846	+\$362	+\$723
	INBEZE3072	74.75"	29.675"	\$2855	+\$58	+\$29	+\$914	+\$370	+\$737	
	24" D Manual Pneumatic Height Adjustable Worksurface Open End Leg Application	INBEZOE2436	38.536"	23.675"	\$2108	+\$33	+\$16	+\$675	+\$289	+\$577
		INBEZOE2442	44.536"	23.675"	\$2134	+\$34	+\$17	+\$683	+\$309	+\$617
		INBEZOE2448	50.536"	23.675"	\$2181	+\$39	+\$19	+\$698	+\$315	+\$628
		INBEZOE2454	56.536"	23.675"	\$2240	+\$45	+\$24	+\$717	+\$320	+\$638
		INBEZOE2460	62.536"	23.675"	\$2286	+\$48	+\$26	+\$732	+\$332	+\$663
	INBEZOE2472	74.536"	23.675"	\$2721	+\$58	+\$29	+\$871	+\$334	+\$666	
	30" D Manual Pneumatic Height Adjustable Worksurface Open End Leg Application	INBEZOE3036	38.536"	29.675"	\$2185	+\$33	+\$16	+\$700	+\$332	+\$662
		INBEZOE3042	44.536"	29.675"	\$2228	+\$34	+\$17	+\$713	+\$352	+\$703
		INBEZOE3048	50.536"	29.675"	\$2286	+\$39	+\$19	+\$732	+\$355	+\$708
		INBEZOE3054	56.536"	29.675"	\$2580	+\$45	+\$24	+\$826	+\$359	+\$717
		INBEZOE3060	62.536"	29.675"	\$2641	+\$48	+\$26	+\$846	+\$362	+\$723
	INBEZOE3072	74.536"	29.675"	\$2855	+\$58	+\$29	+\$914	+\$370	+\$737	

General information

- Specific worksurfaces must be used in specific applications based on location and end support
- This electric height adjustable table with two motors has a lift capacity of 195lbs (includes worksurface)
- Height adjustment is 28.5" to 44.5"; a total range of 16"
- Base comes in silver only
- Nuform, Laminate & Veneer
- Straight & Tapered edge available on Nuform
- End units are ½" shorter in length and Middle units are ½" shorter on each end eliminating potential pinch points
- Can be installed on a Full Height or Partial Height Spine with Full End support. No mid support is required
- Only to be installed on Full Height Panel option - with either full height end gable or open end leg
- See Inscape Bench Application Guide for more details
- Stretcher bars not required for Height Adjustable worksurfaces

Digital handset





For optional digital handset, add +\$79 to list price.

Notes

In order to get a total cost on products when upcharges are present take the list price of the product number and add the upcharge cost shown to the list price.

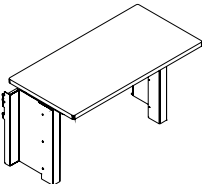
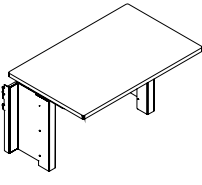
For example:

Product INBELAKM2448 in Veneer would be \$3375 +\$564

Description	Part number	Width	Depth	Nuform/laminate	Nuform woodgrain/pattern	Nuform tapered	Grade 1 laminate	Grade 2 laminate	Veneer straight	Accent paint
 <p>24" D Electric Height Adjustable Worksurface Middle Application</p>	INBELAKM2448	47"	23.675"	\$3375	+\$39	+\$19	+\$1080	+\$283	+\$564	+\$338
	INBELAKM2454	53"	23.675"	\$3416	+\$45	+\$24	+\$1094	+\$287	+\$573	+\$343
	INBELAKM2460	59"	23.675"	\$3458	+\$48	+\$26	+\$1107	+\$298	+\$595	+\$347
	INBELAKM2472	71"	23.675"	\$3544	+\$58	+\$29	+\$1135	+\$321	+\$641	+\$356
 <p>30" D Electric Height Adjustable Worksurface Middle Application</p>	INBELAKM3048	47"	29.675"	\$3458	+\$43	+\$19	+\$1107	+\$319	+\$637	+\$347
	INBELAKM3054	53"	29.675"	\$3509	+\$54	+\$24	+\$1123	+\$323	+\$645	+\$352
	INBELAKM3060	59"	29.675"	\$3565	+\$61	+\$26	+\$1141	+\$325	+\$649	+\$358
	INBELAKM3072	71"	29.675"	\$3669	+\$72	+\$29	+\$1175	+\$333	+\$665	+\$368
 <p>24" D Electric Height Adjustable Worksurface Full End Gable Application</p>	INBELAKE2448	50.25"	23.675"	\$3544	+\$39	+\$19	+\$1135	+\$297	+\$592	+\$356
	INBELAKE2454	56.25"	23.675"	\$3589	+\$45	+\$24	+\$1149	+\$301	+\$600	+\$360
	INBELAKE2460	62.25"	23.675"	\$3631	+\$48	+\$26	+\$1162	+\$314	+\$626	+\$364
	INBELAKE2472	74.75"	23.675"	\$3719	+\$58	+\$29	+\$1191	+\$337	+\$672	+\$373
 <p>30" D Electric Height Adjustable Worksurface Full End Gable Application</p>	INBELAKE3048	50.25"	29.675"	\$3631	+\$43	+\$19	+\$1162	+\$335	+\$668	+\$364
	INBELAKE3054	56.25"	29.675"	\$3686	+\$54	+\$24	+\$1180	+\$340	+\$678	+\$370
	INBELAKE3060	62.25"	29.675"	\$3743	+\$60	+\$26	+\$1198	+\$342	+\$682	+\$375
	INBELAKE3072	74.75"	29.675"	\$3852	+\$72	+\$29	+\$1233	+\$350	+\$699	+\$386
 <p>24" D Electric Height Adjustable Worksurface Open End Leg Application</p>	INBELAKO2448	50.536"	23.675"	\$3544	+\$39	+\$19	+\$1135	+\$297	+\$592	+\$356
	INBELAKO2454	56.536"	23.675"	\$3589	+\$45	+\$24	+\$1149	+\$301	+\$600	+\$360
	INBELAKO2460	62.536"	23.675"	\$3631	+\$48	+\$26	+\$1162	+\$314	+\$626	+\$364
	INBELAKO2472	74.536"	23.675"	\$3719	+\$58	+\$29	+\$1191	+\$337	+\$672	+\$373
 <p>30" D Electric Height Adjustable Worksurface Open End Leg Application</p>	INBELAKO3048	50.536"	29.675"	\$3631	+\$43	+\$19	+\$1162	+\$335	+\$668	+\$364
	INBELAKO3054	56.536"	29.675"	\$3686	+\$54	+\$24	+\$1180	+\$340	+\$678	+\$370
	INBELAKO3060	62.536"	29.675"	\$3743	+\$60	+\$26	+\$1198	+\$342	+\$682	+\$375
	INBELAKO3072	74.536"	29.675"	\$3852	+\$72	+\$29	+\$1233	+\$350	+\$699	+\$386

Bench





Worksurfaces

Worksurfaces Supports

General information

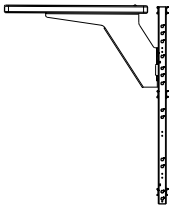
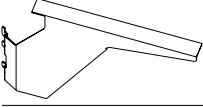
- Cantilever brackets support worksurfaces at mid-span
- Spacers are to be specified in conjunction with 22.5" id cases and 3/8" thick tops to support worksurfaces
- Pedestal brackets dock pedestal cases to the benching spine. See Inscape Bench Application Guide
- Frame to Worksurface is to be specified in certain configurations where storage is the anchor. See Inscape Bench Application Guide

- Stretcher bars are required to be specified with worksurfaces 54" and wider which do not have any mid support
- Stretcher bars are also required for all 30" or deeper worksurfaces no matter the width including when mid cantilever is installed
- Be sure stretcher bars do not interfere with support brackets, cable trays or other work tools
- Stretcher bars not required for Height Adjustable worksurfaces
- Stretcher bars are 1 1/2" high

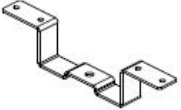





Description	Pat number	Height	Eco black/ List price	Neutral paint	Accent paint
 Cantilever Bracket Fixed Height Handed	INBRHCB right-handed	—	\$79	+\$4	+\$9
	INBLHCB left-handed	—	\$79	+\$4	+\$9
 120° Cantilever Bracket	INB120CB	—	\$67	+\$10	+\$8
 Spacers (pkg.4)	WSPACERLAT For Laterals	1.3"	\$59	+\$0	+\$7
	WSPACERPED For Pedestals	1.3"	\$31	+\$0	+\$4
 Pedestal Bracket, End Location	INBPEDLHBREDE left-handed (illustrated)	—	\$79	+\$0	+\$9
	INBPEDRHBREDE right-handed	—	\$79	+\$0	+\$9
 Pedestal Bracket, Middle Location	INBPEDLHBRMDE left-handed (illustrated)	—	\$79	+\$0	+\$9
	INBPEDRHBRMDE right-handed	—	\$79	+\$0	+\$9
 Frame to Worksurface Connection Bracket	INBSPWSBRKT Double Sided	—	\$78	+\$0	+\$9
	INBSPWBRKTSS Single Sided	—	\$79	+\$0	+\$9

Description	Part number	Width	Weight (lbs)	Eco black	Painted
 Worksurface Stretcher Bar For use with worksurfaces 54" and wider	INSBK54 For use with 54" surface	44"	—	\$66	—
	INSBK60 For use with 60" surface	50"	—	\$98	—
	INSBK72 For use with 72" surface	62"	—	\$117	—
	INSBK84 For use with 84" surface	74"	—	\$140	—
	INSBK96 For use with 96" surface	86"	—	\$159	—

General information

- Perpendicular worksurface to spine support brackets support a perpendicular worksurface at the end of a spine frame at 28.5" high. These brackets are handed left or right and there is a double sided option
- The handedness of the support bracket is determined from the user perspective (i.e. a left handed bracket would install on the left hand side of the user)
- Shared worksurface support brackets are used to support either a 30"d or 36"d shared worksurface off of a spine frame(s) and are available in on module and mid module applications. See Inscape Bench Application Guide for application guidelines

- Brackets are available in all standard paint finishes
- The angled wood fixed worksurface support leg supports the end of a perpendicular or shared worksurface that is not bracketed to the spine frames
- Wood support legs are available in Clear Maple and Black finishes
- Height Adjustable Foot Docking Bracket must be specified when spine is freestanding with height adjustable tables
- Foot Docking Bracket for use with no accessories can be used in parallel or perpendicular applications
- Foot Docking Bracket for use with accessories can only be used in perpendicular applications

Description	Part number	Height	Neutral paint	Accent paint
 <p>Perpendicular Worksurface to Spine Support Bracket</p> <p>Left hand bracket</p>	INBWSBPERPLH Single left hand bracket	—	\$149	+\$16
	INBWSBPERPRH Single right hand bracket	—	\$149	+\$16
	INBWSBPERPBB Double sided back-to-back bracket	—	\$222	+\$23
 <p>Shared Worksurface Support Bracket</p> <p>On module</p>	INWSHSBRKT-OM For on module applications	—	\$108	+\$12
	INWSHSBRKT-OFF For mid module applications	—	\$208	+\$22
 <p>Shared Worksurface Support Bracket</p> <p>Mid module</p>				
 <p>Height Adjustable Foot Docking Bracket</p> <p>With Accessories</p>	INBHAFDBRKTACCY For Bench Spine with Accessories Attached	—	\$20	+\$3
	INBHAFDBRKTACCN For Bench Spine with No Accessories	—	\$20	+\$3
 <p>Height Adjustable Foot Docking Bracket</p> <p>No Accessories</p>				
Description	Part number	Height	List price	
 <p>Angled Wood Fixed Worksurface Support Leg</p>	TANGCONPL28.5 Single leg	27 ¾"	\$438	

Worksurfaces

Worksurfaces Supports

General information



- 3/8" thick tops are available in Nuform (straight edge), Laminate and Veneer
- Tops are specified on 22.5" id cases along with spacers to support surfaces at 28.5"h
- Pedestal top depths are sized so that the tops line up flush with the front of the pedestals and go all the way to the front of the tile behind, covering the docking bracket space
- Tops are not available with plywood edge band

Notes

In order to get a total cost on products when upcharges are present take the list price of the product number and add the upcharge cost shown to the list price.

For example:

Product INSWTOP1836 in Veneer would be \$206 +\$379

Description	Part number	Width	Depth	Nuform solid/ laminate	Nuform woodgrain/ pattern	Grade 1 laminate	Veneer
 22" D x 3/8" T Pedestal Top	INBPEDTOP1522 For 7900 series	15"	23 5/8"	\$96	+\$13	+\$31	+\$402
	INBPEDTOP1522.7 For 9900 series	15"	24 1/3"	\$106	+\$11	+\$34	+\$409
 28" D x 3/8" T Pedestal Top	INBPEDTOP1528 For 7900 series	15"	29 5/8"	\$119	+\$13	+\$39	+\$409
	INBPEDTOP1528.7 For 9900 series	15"	30 1/3"	\$126	+\$21	+\$41	+\$424
 18" D x 3/8" T Lateral Top	INSWTOP1830	30"	18"	\$192	+\$11	+\$62	+\$333
	INSWTOP1836	36"	18"	\$206	+\$30	+\$66	+\$379
	INSWTOP1842	42"	18"	\$232	+\$37	+\$75	+\$413
	INSWTOP1848	48"	18"	\$257	+\$44	+\$83	+\$449
	INSWTOP1854	54"	18"	\$285	+\$45	+\$92	+\$489
	INSWTOP1860	60"	18"	\$441	+\$47	+\$142	+\$846
	INSWTOP1872	72"	18"	\$527	+\$54	+\$169	+\$860
INSWTOP1878	78"	18"	\$613	+\$63	+\$197	+\$836	

General information

- When specifying a Full Gable End Supports, choose the base, then option of inside and outside tiles and finally choose the worksurface support option
- Full Gable End Supports have options of Nuform, laminate, paint, veneer or no tile
- Full Gable Mid Support is available in paint and no tile
- Option "NO" interior tile when a Trading Desk unit is being installed
- Nuform, Laminate or Veneer with a pattern will run the length of the gable
- Full Gable Supports must be used with Full Height Spine Frames
- For single-sided applications, use 18" mid supports for 24" D surfaces and 24" mid supports for 30" D surfaces
- 36" D single-sided Bench applications are not available
- Nuform Herringbone tile options is only available on the outside of the end gable.

Notes

In order to get a total cost on products when upcharges are present take the list price of the product number and add the upcharge cost shown to the list price.

**For example:
 Product INBFEG28.548 with inside and outside in Laminate with fixed height worksurfaces supports on both sides would be \$798 +\$703 +\$772 +\$191**

Part number	Height	Width	Neutral paint/ base price	Inside tile finish options						Outside tile finish options							
				No tile	Paint	Nuform	Laminate	Grade 1 laminate	Veneer	No tile	Paint	Nuform	Nuform Herringbone	Laminate	Grade 1 laminate	Veneer	Accent paint
INBFEG28.548	28 1/2"	48"	\$798	+\$0	+\$140	+\$456	+\$703	+\$719	+\$753	+\$0	+\$198	+\$772	+\$864	+\$772	+\$823	+\$926	+\$81
INBFEG28.560	28 1/2"	60"	\$860	+\$0	+\$296	+\$475	+\$709	+\$768	+\$886	+\$0	+\$200	+\$824	+\$922	+\$824	+\$902	+\$1058	+\$87
INBFEG28.572	28 1/2"	72"	\$885	+\$0	+\$303	+\$501	+\$717	+\$818	+\$1019	+\$0	+\$219	+\$864	+\$968	+\$864	+\$972	+\$1188	+\$90



Full Gable End Support

Product number	Worksurface support options					
	Fixed height	Manual Height Adjustable	Electric Height Adjustable	Electric and Manual Height Adjustable	Electric Height Adjustable & Fixed	Manual Height adjustable & Fixed
INBFEG28.548	+\$191	+\$191	+\$0	+\$96	+\$96	+\$191
INBFEG28.560	+\$191	+\$191	+\$0	+\$96	+\$96	+\$191
INBFEG28.572	+\$191	—	—	—	—	—

INBSFEG28.524	28 1/2"	24"	\$494	+\$0	+\$104	+\$404	+\$404	+\$431	+\$486	+\$0	+\$104	+\$404	+\$453	+\$404	+\$431	+\$486	+\$50
INBSFEG28.530	28 1/2"	30"	\$532	+\$0	+\$107	+\$432	+\$432	+\$473	+\$555	+\$0	+\$107	+\$432	+\$484	+\$432	+\$473	+\$555	+\$54

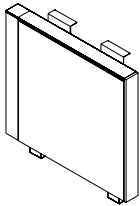

Single-Sided Full Gable End Support

Product number	Worksurface support options					
	Fixed height	Manual Height Adjustable	Electric Height Adjustable	Electric and Manual Height Adjustable	Electric Height Adjustable & Fixed	Manual Height adjustable & Fixed
INBSFEG28.524	+\$96	+\$96	+\$0	—	—	—
INBSFEG28.530	+\$96	+\$96	+\$0	—	—	—

INBFEG28.512	28 1/2"	12"	\$594	-\$79	+\$0	—	—	—	—	-\$79	+\$0	—	—	—	—	—	+\$60
INBFEG28.518	28 1/2"	18"	\$622	-\$90	+\$0	—	—	—	—	-\$90	+\$0	—	—	—	—	—	+\$63
INBFEG28.524	28 1/2"	24"	\$651	—	+\$0	—	—	—	—	—	+\$0	—	—	—	—	—	+\$66



Full Gable Mid Support

Product number	Worksurface support options							
	Fixed height	Manual Height Adjustable	Electric Height Adjustable	Electric and Manual Height Adjustable	Electric Height Adjustable & Fixed	Manual Height adjustable & Fixed	Manual height adjustable (M) on left & fixed (F) on right	Fixed (F) on left & manual height adjustable (M) on right
INBFEG28.512	+\$0	+\$0	—	—	—	—	+\$0	+\$0
INBFEG28.518	+\$0	+\$0	—	—	—	—	+\$0	+\$0
INBFEG28.524	+\$0	+\$0	—	—	—	—	+\$0	+\$0

M	F	F	M
---	---	---	---

Bench

Worksurfaces

Worksurfaces Supports

Full Gable Brackets

General information

- Brackets for field reconfiguration purposes only
- The handedness of these brackets is chosen from the user perspective of the fixed worksurface

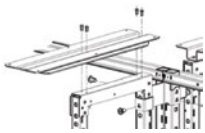
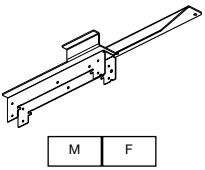
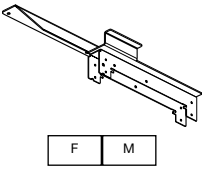
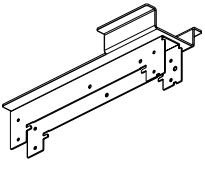
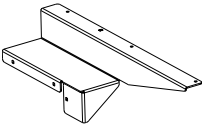
Description	Part number	Height	Depth	Neutral paint/ base price	Accent paint
 <p>Full Gable Mid Support Bracket Only for Supporting 2 Fixed Height Surfaces</p>	INBKTEGFF12 12" D Full Gable	28 ½"	12"	\$84	+\$10
	INBKTEGFF18 18" D Full Gable	28 ½"	18"	\$91	+\$10
	INBKTEGFF24 24" D Full Gable	28 ½"	24"	\$98	+\$11
 <p>Full Gable Mid Support Bracket Only for Supporting Manual Height Adjustable (M) Surface on Left, Fixed (F) Surface on Right</p>	INBKTEGPLFR12 12" D Full Gable	28 ½"	12"	\$84	+\$10
	INBKTEGPLFR18 18" D Full Gable	28 ½"	18"	\$91	+\$10
	INBKTEGPLFR24 24" D Full Gable	28 ½"	24"	\$98	+\$11
 <p>Full Gable Mid Support Bracket Only for Supporting Fixed (F) Surface on Left, Manual Height Adjustable (M) Surface on Right</p>	INBKTEGFLPR12 12" D Full Gable	28 ½"	12"	\$84	+\$10
	INBKTEGFLPR18 18" D Full Gable	28 ½"	18"	\$91	+\$10
	INBKTEGFLPR24 24" D Full Gable	28 ½"	24"	\$98	+\$11
 <p>Full Gable Mid Support Bracket Only for Supporting 2 Manual Height Adjustable Surfaces</p>	INBKTEGPP12 12" D Full Gable	28 ½"	12"	\$84	+\$10
	INBKTEGPP18 18" D Full Gable	28 ½"	18"	\$91	+\$10
	INBKTEGPP24 24" D Full Gable	28 ½"	24"	\$98	+\$11
 <p>Electric Height Adjustable (E) to Fixed (F) Worksurface Support Bracket</p>	INBEHAADBKT-LH left-handed (illustrated)	—	—	\$94	+\$11
	INBEHAADBKT-RH right-handed	—	—	\$94	+\$11

General information

- When specifying an Open H Leg Support, choose the base, then choose the worksurface support option
- Can be used with Full Height, Partial Height and Storage Spine Frames
- Regular height (28.5") and standing height options available
- Standing Height Open H Leg support fixed height worksurfaces only
- Has the ability to support various accessories which hang from the support bar of the leg
- When the Electric Height Adjustable worksurface support option is selected there will be exposed bracket mounting holes visible. For no holes, specify For Electric Height Adjustable Application Only
- Covers for "H" leg are specified when the holes on the interior of the leg are exposed when electric height adjustable is specified. These covers come 4 in a package and two are required under each worksurface

- For single-sided applications, use 18" mid supports for 24" D surfaces and 24" mid supports for 30" D surfaces
- 36" D single-sided Bench applications are not available

Notes

In order to get a total cost on products when upcharges are present take the list price of the product number and add the upcharge cost shown to the list price.

**For example:
 Product INBAHLEG28.548 with fixed height worksurfaces supports on both sides would be \$1042 +\$241**

Description	Part number	Height	Width	Neutral paint/ base price	Accent paint
 Open H Leg End Support For use with regular height applications	INBAHLEG28.548	28 ½"	48"	\$1042	+\$105
	INBAHLEG28.560	28 ½"	60"	\$1063	+\$107
	INBAHLEG28.572	28 ½"	72"	\$1068	+\$108

Worksurface support options

Product number	Fixed height	Manual Height Adjustable	Electric Height Adjustable	Electric and Manual Height Adjustable	Electric Height Adjustable & Fixed	Manual Height adjustable & Fixed
INBAHLEG28.548	+\$241	+\$107	+\$0	+\$54	+\$121	+\$174
INBAHLEG28.560	+\$241	+\$107	+\$0	+\$54	+\$121	+\$174
INBAHLEG28.572	+\$241	—	—	—	—	—

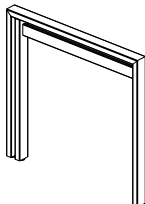
Description	Part number	Height	Width	Neutral paint/ base price	Accent paint
 Single-Sided Open H Leg End Support For use with regular height applications	INBAHEG28.524LH left-handed (illustrated)	28 ½"	24"	\$689	+\$70
	INBAHEG28.524RH right-handed	28 ½"	24"	\$689	+\$70
	INBAHEG28.530LH left-handed (illustrated)	28 ½"	30"	\$738	+\$75
	INBAHEG28.530RH right-handed	28 ½"	30"	\$738	+\$75

Worksurface support options

Product number	Fixed height	Manual Height Adjustable	Electric Height Adjustable	Electric and Manual Height Adjustable	Electric Height Adjustable & Fixed	Manual Height adjustable & Fixed
INBAHEG28.524LH	+\$121	+\$54	+\$0	—	—	—
INBAHEG28.524RH	+\$121	+\$54	+\$0	—	—	—
INBAHEG28.530LH	+\$121	+\$54	+\$0	—	—	—
INBAHEG28.530RH	+\$121	+\$54	+\$0	—	—	—

Description	Part number	Height	Width	Neutral paint/ base price	Accent paint
 Open H Leg Mid Support For use with regular height applications	INBHEG28.512	28 ½"	12"	\$378	+\$39
	INBHEG28.518	28 ½"	18"	\$422	+\$43
	INBHEG28.524	28 ½"	24"	\$485	+\$49

Worksurface support options

Product number	Fixed height	Manual Height Adjustable	Electric Height Adjustable	Electric and Manual Height Adjustable	Electric Height Adjustable & Fixed	Manual Height adjustable & Fixed	Manual height adjustable (M) on left & fixed (F) on right	Fixed (F) on left & manual height adjustable (M) on right
INBHEG28.512	—	—	—	—	—	—	—	—
INBHEG28.518	—	—	—	—	—	—	—	—
INBHEG28.524	—	—	—	—	—	—	—	—

M	F	F	M
---	---	---	---

Description	Part number	Height	Width	Neutral paint/ base price	Accent paint
 H Leg Hole Covers	INBHLEGCOVR-4	7/8"	1 3/4"	\$16	+\$3

Worksurfaces

Worksurfaces Supports

Open H Leg

General information

- When specifying an Open H Leg Support, choose the base, then choose the worksurface support option
- Open H Leg Supports can be used with Full Height, Partial Height and Storage Spine Frames
- Regular height (28.5") and standing height options available
- Standing Height Open H Leg support fixed height worksurfaces only
- Has the ability to support various accessories which hang from the support bar of the leg
- When the Electric Height Adjustable worksurface support option is selected there will be exposed bracket mounting holes visible. For no holes, specify For Electric Height Adjustable Application Only

- For single-sided applications, use 18" mid supports for 24" D surfaces and 24" mid supports for 30" D surfaces
- 36" D single-sided Bench applications are not available

Notes

In order to get a total cost on products when upcharges are present take the list price of the product number and add the upcharge cost shown to the list price.

For example:

Product INBAHLEG28.548 with fixed height worksurfaces supports on both sides would be \$1042 +\$241

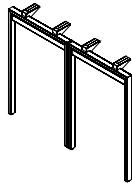
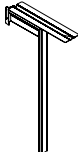
Description	Part number	Height	Width	List price	Accent Paint
 <p>Open H Leg End Support For use with standing height applications</p>	INBSHEG4248	42"	48"	\$1398	+\$141
	INBSHEG4260	42"	60"	\$1749	+\$176
 <p>Open H Leg Mid Support For use with standing height applications</p>	INBSHEG4212	42"	12"	\$614	+\$62

General information

- When specifying an Open O Leg Support, choose the base, then choose the worksurface support option
- Open O Leg Supports can be used with Full Height, Partial Height and Storage Spine Frames
- Open O legs have the option to add glazed inserts which are available in clear, gray and etched 1 side glass. See example for how to price glazed inserts
- Has the ability to support various accessories which hang from the support bar of the leg
- Use Open H leg Mid Supports to support mid applications
- For single-sided applications, use 18" mid supports for 24" D surfaces and 24" mid supports for 30" D surfaces
- 36" D single-sided Bench applications are not available

Notes

In order to get a total cost on products when upcharges are present take the list price of the product number and add the upcharge cost shown to the list price.

For example:
 Product INBAHLEG28.548 with fixed height worksurfaces supports on both sides would be \$885 +\$241
 Product INBAHLEG28.548 with fixed height worksurfaces supports on both sides and Gray glazed insert would be \$885 +\$241 + \$405 +\$46

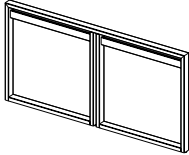
Description	Part number	Height	Width	Neutral paint/ base price	Glazed insert options				Accent paint
					Clear/ base	Gray	Etched 1 Side		
 Open O Leg End Support For use with regular height applications	INBAOLEG28.548	28 1/2"	48"	\$885	\$405	+\$46	+\$140	+\$90	
	INBAOLEG28.560	28 1/2"	60"	\$917	\$579	+\$66	+\$199	+\$93	
	Worksurface support options								
	Product number	Fixed height	Manual Height Adjustable	Electric Height Adjustable	Electric and Manual Height Adjustable	Electric Height Adjustable & Fixed	Manual Height adjustable & Fixed		
	INBAOLEG28.548	+\$241	+\$107	+\$0	+\$54	+\$121	+\$174		
	INBAOLEG28.560	+\$241	+\$107	+\$0	+\$54	+\$121	+\$174		

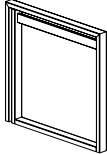
 Single-Sided Open O Leg End Support For use with regular height applications	INBAOEG28.524LH left-handed (illustrated)	28 1/2"	24"	\$694	\$311	+\$47	+\$91	+\$71
	INBAOEG28.524RH right-handed	28 1/2"	24"	\$694	\$311	+\$47	+\$91	+\$71
	INBAOEG28.530LH left-handed (illustrated)	28 1/2"	30"	\$759	\$348	+\$40	+\$120	+\$77
	INBAOEG28.530RH right-handed	28 1/2"	30"	\$759	\$348	+\$40	+\$120	+\$77
	Worksurface support options							
	Product number	Fixed height	Manual Height Adjustable	Electric Height Adjustable	Electric and Manual Height Adjustable	Electric Height Adjustable & Fixed	Manual Height adjustable & Fixed	
	INBAOEG28.524LH	+\$121	+\$54	+\$0	—	—	—	
	INBAOEG28.524RH	+\$121	+\$54	+\$0	—	—	—	
	INBAOEG28.530LH	+\$121	+\$54	+\$0	—	—	—	
	INBAOEG28.530RH	+\$121	+\$54	+\$0	—	—	—	

Bench

Worksurfaces

Worksurfaces Supports

For Electric Height Adjustable Application Only

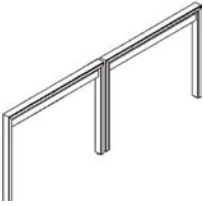
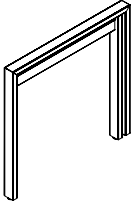
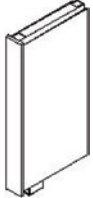

General information

- Supports for Electric Height Adjustable applications only
- No holes will be visible on these supports
- For single-sided applications, use 18" mid supports for 24" D surfaces and 24" mid supports for 30" D surfaces
- 36" D single-sided Bench applications are not available

Description	Part number	Width	Depth	Neutral paint/ base price	Accent paint
 <p>Open H Leg End Support for Height Adjustable Worksurfaces only For use with regular height applications</p>	INBHLEGHAW48	28 ½"	48"	\$902	+\$91
	INBHLEGHAW60	28 ½"	60"	\$906	+\$92
 <p>Single-Sided Open H Leg End Support for Height Adjustable Worksurfaces only For use with regular height applications</p>	INBHLEGHAW24LH	28 ½"	24"	\$559	+\$56
	INBHLEGHAW24RH	28 ½"	24"	\$559	+\$56
	INBHLEGHAW30LH	28 ½"	30"	\$624	+\$63
	INBHLEGHAW30RH	28 ½"	30"	\$624	+\$63
 <p>Full Gable Mid Support for Height Adjustable Worksurfaces only For use with regular height applications</p>	INBFEGADJ12	28 ½"	12"	\$594	+\$60
	INBFEGADJ18	28 ½"	18"	\$603	+\$61
	INBFEGADJ24	28 ½"	24"	\$633	+\$64

General information

- Specified based on where filler is to be installed (mid or end)
- Provides a gap for cord management between the filler and the main worksurface (to accommodate adapters, the filler can easily be removed and replaced)

Description	Part number	Width	Depth	Neutral paint/ Laminate/ base price	Grade 1 laminate	Veneer	Accent paint
 Worksurface Top Filler Cap, Middle Application	INBWM42	42"	2 3/4"	\$471	+\$151	+\$278	+\$48
	INBWM48	48"	2 3/4"	\$484	+\$155	+\$285	+\$49
	INBWM54	54"	2 3/4"	\$513	+\$165	+\$302	+\$52
	INBWM60	60"	2 3/4"	\$521	+\$167	+\$306	+\$53
	INBWM72	72"	2 3/4"	\$617	+\$198	+\$363	+\$62
	INBWM84	84"	2 3/4"	\$683	+\$219	+\$401	+\$70
	INBWM96	96"	2 3/4"	\$699	+\$224	+\$412	+\$71
 Worksurface Top Filler Cap, Full End Gable Application	INBWE42	42"	2 3/4"	\$477	+\$153	+\$281	+\$48
	INBWE48	48"	2 3/4"	\$488	+\$157	+\$288	+\$49
	INBWE54	54"	2 3/4"	\$518	+\$166	+\$305	+\$52
	INBWE60	60"	2 3/4"	\$526	+\$169	+\$309	+\$53
	INBWE72	72"	2 3/4"	\$629	+\$202	+\$371	+\$63
	INBWE84	84"	2 3/4"	\$696	+\$223	+\$410	+\$71
	INBWE96	96"	2 3/4"	\$794	+\$255	+\$466	+\$81
 Worksurface Top Filler Cap, Open "H" Leg Application	INBWO42	42"	2 3/4"	\$477	+\$153	+\$281	+\$48
	INBWO48	48"	2 3/4"	\$488	+\$157	+\$288	+\$49
	INBWO54	54"	2 3/4"	\$518	+\$166	+\$305	+\$52
	INBWO60	60"	2 3/4"	\$526	+\$169	+\$309	+\$53
	INBWO72	72"	2 3/4"	\$629	+\$202	+\$371	+\$63
	INBWO84	84"	2 3/4"	\$696	+\$223	+\$410	+\$71
	INBWO96	96"	2 3/4"	\$794	+\$255	+\$466	+\$81

Left blank intentionally.

bench

Storage

Pedestals

Pedestals are of all-welded “wrap-around” construction of 20 and 22 gauge high quality, tension leveled, cold rolled steel. The steel gauge selected for drawer fronts, bodies and accessories ensure the highest quality durability and performance for all components. All glides on cases must be specified as flat glides ($\frac{1}{8}$ ” height adjustability) to work with Inscape Bench. Pedestal corners are welded at junction of top and case, eliminating horizontal lines for a cleaner, flush appearance, and strengthened with reinforcing gussets. A completely enclosed case provides rigid construction and dust-free interiors.

Box drawer sides are slotted on 1” centers to allow for maximum flexibility for drawer division. Double-wall construction allows lift-up doors to be picked up and recede smoothly, eliminates deformation, ensures flush fit within cabinet and improves lock performance. 7900 is single-wall construction. File (10.5” and 12”) and EDP (15”) drawer bodies have full height sides to accommodate hanging file folders, eliminating the need for optional file frames. Fully progressive ball bearing suspensions on all drawers, including pencil and box drawers, are staged so that the left and right sides work in unison; this provides smooth drawer operation with minimum force. Staged suspensions allow the drawer to be completely pulled out, providing access to the entire drawer depth.

Special “claw-like” device incorporated in the suspension “grips” the fixed section of the suspension channel preventing drawer body bounce back or creep when drawer is closed. Modular interior allows complete interchangeability of drawer types within the pedestal case. For example, two 6” box drawers may be replaced by a 12” file drawer. Pedestals are standard with keyholes for attachment to underside of worksurface. For the 7900 only cases: 18” deep pedestals come standard with 18” deep drawers, 22” and 28” deep pedestals come standard with 22” deep drawers. For all other Series, pedestal drawers match case depth.

Worksurface supporting pedestals are designed for use with the Inscape Bench when used with flat glides. Worksurface supporting pedestals are available in two depths to fit 24” and 30” deep worksurfaces and support finished worksurface height of 28.5”. Pedestals with 3”, 6” or 7.5” drawers include one pencil tray per pedestal. The 6” and 7.5” drawers also include a steel divider. The 10.5” and 12” drawers have one hang file suspension bar (two in a 28” deep pedestal) for side-to-side filing of legal or letter size folders or printout binders. 7900 Pedestals do not include any suspension bars.

Note: System storage pedestal cases consist of holes in the top of the case and back of the case to allow for worksurface docking and panel mounted brackets to be secured.

Cushion Mobile Pedestals

Cushion Mobile Pedestals are topped with 1.25” thick Cal.117 fire-retardant polyurethane foam with a 2.2lb/ft. density. This upholstery cushion is balanced with a $\frac{1}{8}$ ” board and is attached to a pedestal top with Velcro. Select from our graded upholstery program of solid color fabrics and vinyl’s or choose COM option (Customers Own Material). To determine if a COM fabric has been pre-approved for use on our cushion topper, contact your client services representative or go to www.inscapesolutions.com. For application of ALL fabrics, both from our graded program as well as COM (Customer Own Material) please specify layout orientation at time of order. If layup instructions are not provided Inscape will choose the direction to maximize production. Refer to the diagram for layup options.

After calculating the total amount of material needed in inches, divide the total number of inches by 36 for the total yardage and round up to the next full yard. Allow additional for repeat. Add 15% of total fabric required for small and medium pattern repeats. Add 20% of total fabric required for large patterns.

Due to the nature of the design and manufacture of our cushion,

only approved fabrics will be accepted for application. For a description of the procedure required for COM fabric approval see sample ‘Cushion COM Test Request’ form found in the General Information section of this price list. This form can be downloaded from the Administration section of Insite or by contacting your client services representative for assistance.

Fabric lay up of Pedestal Cushions

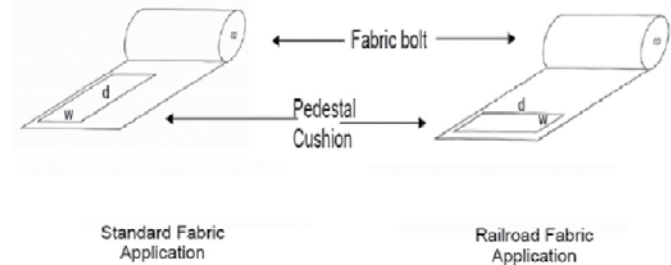

Pedestals come standard with lock. If lock is not required add suffix ‘/NL’ after product number and deduct \$48 list per lock. Random keying is standard, and keyed alike may be ordered.

Locks feature removable core and are standard with two keys, one of which has a black neoprene plastic key cover. Locks may be ordered for field installation. Specify cabinet height and width or model number. Note: Locks cannot be field installed on hinged door cabinets.

Laterals

Lateral cabinets are of all-welded construction using 20 and 22 gauge high quality, tension leveled, and cold rolled steel. Drawer fronts, lift-up doors, roll-out shelves and all steel accessories are manufactured of the steel gauge appropriate to function at the highest quality level. Laterals must be specified with flat glides to work with Inscape Bench. Flat Glides provide 0.125” height adjustment when docked and 0.75” height adjustment if unit is not docked.

With the addition of counterweights where appropriate, cabinets meet all BIFMA specifications. All interiors are completely modular and interchangeable so that cabinets can be retrofitted with new accessories and interiors as required. Cabinet corners (except for 7900) are welded at junction of top and case, eliminating horizontal lines for cleaner, flush appearance, and strengthened with reinforcing gussets. Double-wall construction allows lift-up doors to be picked up and receded smoothly, eliminates deformation, ensures flush fit within cabinet and improves lock performance. Lift-up door carrier mechanism has four nylon rollers two on each side - for smooth receding action with no binding or snagging. Self-closing, 110° opening, European style cupboard hinges for smooth door operations.

The absence of scissor mechanism in doors and drawers eliminates the potential for scissors binding, and facilitates reconfiguration of cabinet openings as needed. Front leading edge of pullout shelves is beaded and rolled to provide grip for pullout action and strengthen shelf; front leading edge of fixed shelf is flat for easy removal of material. Fully progressive ball bearing suspension slides provide smooth action with minimum force.

Special “claw-like” device incorporated in suspension slide channel “grips” the fixed section of the suspension channel preventing drawer bounce-back or creep when drawer is closed. A patented Safelock™ interlock mechanism provides complete security and user safety against accidental opening of two or more drawers simultaneously. Lock fingers are configured with right angle bend upward not downward so that lift-up doors cannot be pulled down to disengage fingers from door slots and be forced to circumvent lock system. Lock bars operate vertically on both sides of cabinet for maximum security.

Knockouts that are included on case sides, top and bottom facilitate ganging and leveling. Glides - 2 in front and 2 in back - are adjustable from inside the cabinet so that cabinets can be leveled regardless of whether they are backed against a wall or banked.

9900 Series fronts have full width integral pulls with enamel finish to match case fronts. 7900 Series fronts are available with 2 pull options. The standard pull option is the radius aluminum pull. A rectangular aluminum pull option is also available at no additional cost. 7900 is single-wall construction. Nuform fronts include a Q- pull. Veneer fronts are available with 2 pull options. The standard Veneer pull option is the same Q- Pull that comes with the Nuform front. A continuous pull is also available on most veneer units.

Laterals include 1 pair of hang file bars in 10.5" and 12" fixed fronts, 1 EDP kit in 13.5" and 15" fixed fronts, pencil tray in 3" multi-file drawer and steel divider in 7.5" multi-file drawer, steel divider in 6" multi-file drawers and 3 divider plates in 13.5" lift-ups. Fixed shelf in lift-up is slotted in 1" increments. Lateral to panel bracket is required if lateral is positioned on-module.

Note: laterals and multi-files consist of slots in the back of the case to allow for panel mounted brackets to be secured.

Cabinets ship standard with single bitted lock. For applications requiring higher security a double bitted solution is available. If lock is not required it may be optioned as such. Random keying is standard, keyed alike is optional. Cabinets originally ordered as non-locking may be field installed with the addition of locking bars and a lock core. Contact your client services representative for required parts. Locks may not be field installed in hinged door and sliding door cabinets. Master keys are available; refer to the accessories section to specify. Locks are standard with two keys, one of which has a black neoprene plastic cover.

All laterals are finished in standard 36.5° gloss baked enamel, electrostatically applied in a 2-coat process. Refer to the surface materials section for available colors. With the exception of custom micas, whites and metallic; custom colors are available at an up-charge and are be subject to extended lead times. For laterals specified in custom micas, specials whites or metallic, add an up-charge of 10% to the list price. All interior drawers/shelf bodies, exposed hardware (excluding European style hinges) hang file bars, dividers and media frames are finished in Eco Black.

Twin-bins

Twin-Bins are 5.75" deep on each side of the supporting frame. Twin-Bins may be specified to install in stack frames above the worksurface. Bins are manufactured from minimum 20 gauge steel with an extruded aluminum reinforced top. Double wall, sliding doors on each side of the unit, slide easily across the recessed groove built into the bin front. Twin-Bins are available with or without locks. The locking mechanism is individualized for each side of the unit, allowing for personal privacy on either side. Twin-Bins are available in 36", 42", 48" and 60" widths. Recommended maximum load for Twin-Bins is 3lbs per linear inch. Bins are finished in standard 37.5° gloss baked enamel, electrostatically applied in a 2-coat process and are available in any of the colors shown in our Color Guide. Side pulls on Radius fronts are manufactured from ABS black plastic. Woodgrain fronts are available in any of our standard woodgrain finishes.

Handles are standard in aluminum finish and are located on the front of the sliding door. Case may still be ordered in any of the colors shown in our Color Guide.

Electrified twin bin

The Electrified Twin Bin is built on the same premise as the standard Twin Bin with the addition of electrical and a sliding door with locking capabilities in two positions. All electrical components are specified separately including power track, receptacles and jumper cables. The sliding door may lock either the binder storage portion (full depth of bin) or the electrified portion which is the center portion which is approximately 5"d. The back of the Electrified Twin Bin may be clad with either a tackboard or whiteboard which are both specific to this storage unit. A shelf may also be optioned for the electrified portion which is field installed midway between top and bottom of opening. A gap in the shelf allows for the cord of an electronic unit to plug into duplex (located near base of opening) and still sit on top of shelf.

Note: These accessories are NOT compatible with the standard Twin Bin.

See Inscape Bench Application Guide for criteria on which heights of stack-on to use in conjunction with the Twin Bin and Electrified Twin Bin

Specify twin-bin mounting brackets

Specify Twin-Bin Mounting Brackets separately according to location on frame. 1 bracket per Twin-Bin is required. When stacking Twin-Bins a 6.75" high tile minimum must separate the two. Do not specify over Power Track Kit. It is not recommended to specify Twin-Bins on wing panels. Twin-Bins should only be specified on spine panels for adequate stability. See Inscape Bench Application Guide for details.

Drawer standard equipment

Lockers and towers containing 3" or 6" drawers are provided with one pencil tray per cabinet. 6" drawers are additionally standard with one steel divider. 10.5", 12" and 15" letter-width file drawers have one suspension bar for side-to-side filing of letter or legal-size folders. Full-width pullout drawers are standard with one pair hang file bars for side-to-side suspended filing. Full-width fixed shelves are standard with 3 plate dividers. Optional accessories are available.

Glides



Overall heights are inclusive of metal glides. Heights may be increased up to 5/8" by extending the standard glide. Glides are accessible from inside the cabinet when the bottom drawer is fully extended or removed and may be adjusted with a 0.25" socket driver. Optional 1.5" stem glides are available. Specify and add \$24 list to the cabinet price. Requires field installation.

Storage

General information

Front details & pull options

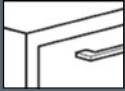
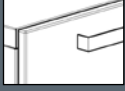
9900 Series fronts have full width integral pulls with enamel finish to match case fronts. 7900 is single-wall construction. Refer to the images and chart below for pull application on 7900 Series, Nuform, and Veneer fronts.

Pull	7900 Series
 <p>FP001 P290 Aluminum Leaf Finish</p>	
 <p>FP004 Brushed Nickel Finish</p>	
 <p>FP005 Satin Nickel Finish</p>	
 <p>FP007 Brushed Nickel Finish</p>	+\$70
 <p>FP008 Matte Chrome Finish</p>	+\$70
 <p>FP009 Nickel Plated Matte Finish</p>	+\$70

Available Unavailable

Pulls FP004, FP005, FP007 and FP008 meet the guidelines for ADA compliance.

FP005 is the default pull for 7900

Locks

Workplace Towers and Lockers come standard with lock with single bitted lock. For applications requiring higher security, a double bitted solution is available. If lock is not required add suffix '/NL' after product number. Deduct \$48 list per lock.

Locks are available in chrome and black finish. Specify. Random keying is standard. Files may be ordered keyed alike. Locks feature removable core and are standard with two keys, one of which has a black Neoprene plastic key cover. Cabinets originally ordered as non-locking may be field installed with the addition of locking bars and a lock core. Please contact Inscape Client Services for required parts. Locks may not be field installed in hinged and sliding door cabinets. Specify lateral file height and width or model number. Master keys are available at \$43 list.

Custom colors

Inscape System offers color matched to a customers' specification when possible. This matching is done through a database of over 2,000 existing color formulas or the development of a new custom color. A minimum order value of \$3,000 net per custom color, applies to each order. A \$250 net fee applies for each custom color below this minimum. In addition, Custom premium colors (bright whites and bright colors; textured paints; and reflection paints that use mica, aluminum or special chemical to create their reflective properties) will be subject to a 10% upcharge to the net value of the product.

General information

- Includes holes in top and bracket slots in back of case
- 15" letter width pedestal
- Worksurface supporting for 28.5" high
- Be sure to specify a 3/8" top along with spacers to achieve a 28.5" finished worksurface height
- **FLAT GLIDE ONLY** when used with Inscape Bench

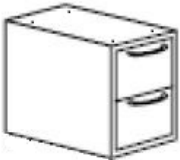
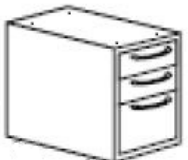
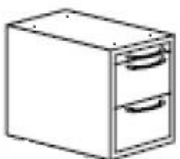
Description	Part number	Height	Width	Depth	Weight (lbs)	Neutral paint/ base price	Accent paint
 <p>10.5" file, 12" file</p>	INGH1522-F10F	25 3/8"	15"	22"	93	\$783	+\$80
	INGH1528-F10F	25 3/8"	15"	28"	105	\$808	+\$82
 <p>2-6" box, 10.5" file</p>	INGH1522-2BF10	25 3/8"	15"	22"	93	\$892	+\$90
	INGH1528-2BF10	25 3/8"	15"	28"	105	\$938	+\$95
 <p>3" pencil, 7.5" box, 12" file</p>	INGH1522-PB7F	25 3/8"	15"	22"	93	\$892	+\$90
	INGH1528-PB7F	25 3/8"	15"	28"	105	\$938	+\$95



Storage

Pedestals

9900 Series Front

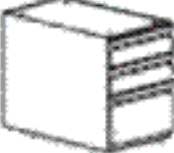

General information

- Includes holes in top and bracket slots in back of case
- Worksurface supporting for 28.5" high
- Be sure to specify a ¾" top along with spacers to achieve a 28.5" finished worksurface height
- **FLAT GLIDE ONLY** when used with Inscape Bench

Description	Part number	Height	Width	Depth	Weight (lbs)	Neutral paint/ base price	Accent paint	
	10.5" File, 12" File Flat Glides	INGE1522-F10F	25 ¾"	15"	22 ¾"	95	\$797	+\$81
		INGE1528-F10F	25 ¾"	15"	28 ¾"	105	\$828	+\$84
		Letter Width						
		INGE1822-F10F	25 ¾"	18"	22 ¾"	100	\$930	+\$94
		INGE1828-F10F	25 ¾"	18"	28 ¾"	110	\$968	+\$98
		Legal Width						
	2-6" box, 1-10.5" file Flat Glides	INGE1522-2BF10	25 ¾"	15"	22 ¾"	95	\$903	+\$91
		INGE1528-2BF10	25 ¾"	15"	28 ¾"	105	\$946	+\$96
		Letter Width						
		INGE1822-2BF10	25 ¾"	18"	22 ¾"	100	\$1051	+\$106
		INGE1828-2BF10	25 ¾"	18"	28 ¾"	110	\$1103	+\$111
		Legal Width						
	3" pencil, 7.5" box, and 12" file Flat Glides	INGE1522-PB7F	25 ¾"	15"	22 ¾"	95	\$905	+\$92
		INGE1528-PB7F	25 ¾"	15"	28 ¾"	105	\$950	+\$96
		Letter Width						
		INGE1822-PB7F	25 ¾"	18"	22 ¾"	100	\$1052	+\$106
		INGE1828-PB7F	25 ¾"	18"	28 ¾"	110	\$1100	+\$111
		Legal Width						

General information

- Worksurface supporting for 28.5" high
- Be sure to specify a 3/8" top along with spacers to achieve a 28.5" finished worksurface height
- **FLAT GLIDE ONLY** when used with Inscape Bench

Description	Part number	Height	Width	Depth	Weight lbs)	Neutral paint/ base price	Accent paint
 <p>10.5" file, 12" file Flat Glides</p>	3022.5H-F10F	25 3/8"	30"	18"	—	\$943	+\$95
	3622.5H-F10F	25 3/8"	36"	18"	—	\$1035	+\$104
	4222.5H-F10F	25 3/8"	42"	18"	—	\$1138	+\$115
 <p>3" pencil, 7.5" box, 12" file Flat Glides</p>	3022.5H-PB7F	25 3/8"	30"	18"	—	\$969	+\$98
	3622.5H-PB7F	25 3/8"	36"	18"	—	\$1057	+\$107
	4222.5H-PB7F	25 3/8"	42"	18"	—	\$1161	+\$117

Bench



Storage

Laterals

9900 Series Front

General information

- Worksurface supporting for 28.5" high
- Be sure to specify a 3/8" top along with spacers to achieve a 28.5" finished worksurface height
- **FLAT GLIDE ONLY** when used with Inscape Bench

Description	Part number	Height	Width	Depth	Weight (lbs)	Neutral paint/ base price	Accent paint
 10.5" file, 12" file Flat Glides	IN3022.5E-F10F	25 3/8"	30"	18"	—	\$954	+\$96
	IN3622.5E-F10F	25 3/8"	36"	18"	—	\$1046	+\$105
	IN4222.5E-F10F	25 3/8"	42"	18"	—	\$1149	+\$116
 2-6" box, 10.5" file Flat Glides	IN3022.5E-2BF10	25 3/8"	30"	18"	—	\$1091	+\$110
	IN3622.5E-2BF10	25 3/8"	36"	18"	—	\$1206	+\$121
	IN4222.5E-2BF10	25 3/8"	42"	18"	—	\$1318	+\$132
 3" pencil, 7.5" box, 12" file Flat Glides	IN3022.5E-PB7F	25 3/8"	30"	18"	—	\$978	+\$99
	IN3622.5E-PB7F	25 3/8"	36"	18"	—	\$1070	+\$108
	IN4222.5E-PB7F	25 3/8"	42"	18"	—	\$1171	+\$118

General information

- Worksurface supporting for 28.5" high
- Be sure to specify a 3/8" top along with spacers to achieve a 28.5" finished worksurface height
- **FLAT GLIDE ONLY** when used with Inscape Bench

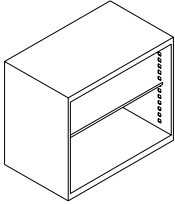
Description	Part number	Height	Width	Depth	Weight (lbs)	Neutral paint/ base price	Accent paint
	Inscape Bench Bookcase	25 3/8"	30"	18"	—	\$929	+\$94
	Flat Glides	25 3/8"	36"	18"	—	\$971	+\$98
		25 3/8"	42"	18"	—	\$1032	+\$104



Storage

Twin-Bins and Brackets

General information

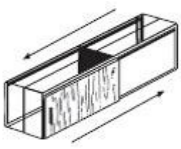
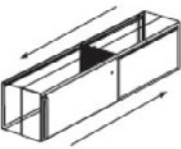
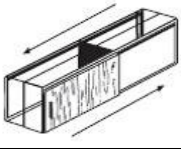
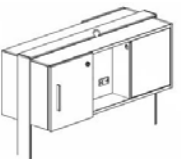
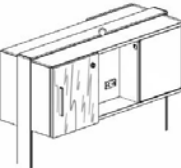
- See Inscape Bench Application Guide for bracket details & locations
- Twin-Bin brackets are quoted separately and are specific to panel thickness
- Twin-Bin cannot be installed directly above a worksurface as it causes interference
- Jumper cables and receptacles for the Electrified Twin Bin power track specified separately
- The "IN3D_UD-8" receptacles are to be specified in conjunction with the Electrified Twin-Bin
- See Inscape System Application Guide for bracket details and locations
- Twin-Bin brackets are specific to frame thickness
- "2F" denotes use with 2.75" thick frame
- Brackets are for use with Bench stack-on frames only

Description	Part number	Height	Width	Weight (lbs)	Neutral paint/ base price	Accent paint
 Nuform Front Twin-Bin	INTWQB36LH	14"	36"	42	\$1263	+\$127
	INTWQB42LH	14"	42"	52	\$1313	+\$132
	INTWQB48LH	14"	48"	58	\$1359	+\$137
	INTWQB54LH	14"	54"	62	\$1374	+\$139
	INTWQB60LH	14"	60"	68	\$1390	+\$140
 Radius Front Twin-Bin	INTWRB36LH	14"	36"	42	\$1133	+\$114
	INTWRB42LH	14"	42"	52	\$1175	+\$118
	INTWRB48LH	14"	48"	58	\$1218	+\$122
	INTWRB54LH	14"	54"	62	\$1236	+\$124
	INTWRB60LH	14"	60"	68	\$1249	+\$125
 Composite Veneer Front Twin-Bin	INTWVB36LH	14"	36"	42	\$1944	+\$195
	INTWVB42LH	14"	42"	52	\$2002	+\$201
	INTWVB48LH	14"	48"	58	\$2112	+\$212
	INTWVB54LH	14"	54"	62	\$2272	+\$228
	INTWVB60LH	14"	60"	68	\$2556	+\$256
 Nuform Front Electrified Twin-Bin	INETWBQ36	14"	36"	42	\$1645	+\$165
	INETWBQ42	14"	42"	52	\$1722	+\$173
	INETWBQ48	14"	48"	58	\$1766	+\$177
	INETWBQ54	14"	54"	62	\$1786	+\$179
	INETWBQ60	14"	60"	68	\$1806	+\$181
 Composite Veneer Front Electrified Twin-Bin	INETWBV36	14"	36"	42	\$2526	+\$253
	INETWBV42	14"	42"	52	\$2630	+\$264
	INETWBV48	14"	48"	58	\$2778	+\$279
	INETWBV54	14"	54"	62	\$2954	+\$296
	INETWBV60	14"	60"	68	\$3339	+\$334

Description	Part number	Width	List price
 Twin-Bin Bracket for install on a 20.25" H Stack-on	INTWBKTUH-36-2F	36"	\$154
	INTWBKTUH-42-2F	42"	\$156
	INTWBKTUH-48-2F	48"	\$159
	INTWBKTUH-54-2F	54"	\$161
	INTWBKTUH-60-2F	60"	\$163
 Twin-Bin Bracket for install on a 27" H Stack-on	INTWBKT-U	—	\$98

General information

- Electrified Twin Bin shelf is installed in opening where electrical is located (center)
- Electrified Twin Bin Whiteboard + Tackboard only compatible with Electrified Twin Bin
- Receptacles are available in color options of black (default), white and gray
- White close match to 168 Glacier White and Gray close match to 290 – Aluminum Leaf
- The circuit 3 receptacle requires 2+2 or 3+1 wire designation (“4” in the code signifies 3+1 compatibility)
- USB power modules can be used with the Electrified Twin-Bin

Note

Only Expo Markers are to be used on any Inscape Whiteboard. Whiteboards should be cleaned with Expo Eraser or a Microfiber cleaning cloth along with Expo Cleaning Solution which is formulated to remove residue from Expo Dry Erase Markers.

Description	Part number	Height	Width	Grade 1/ COM	Grade 2	Grade 3	Grade 4	Grade 5	Grade 6	Grade 7	Grade 8
	Electrified Twin-Bin Tackboard										
	INTWBTB-12	14"	12"	\$112	+\$5	+\$12	—	+\$24	—	+\$64	—
	INTWBTB-14	14"	14"	\$115	+\$5	+\$12	—	+\$24	—	+\$64	—
	INTWBTB-16	14"	16"	\$120	+\$5	+\$12	—	+\$24	—	+\$64	—
	INTWBTB-18	14"	18"	\$126	+\$5	+\$12	—	+\$24	—	+\$64	—
	INTWBTB-20	14"	20"	\$137	+\$5	+\$12	—	+\$24	—	+\$64	—

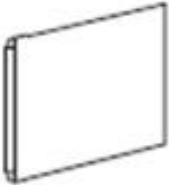
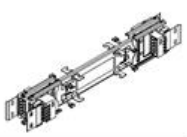
Description	Part number	Height	Width	Weight (lbs)	List price	Accent paint
	Electrified Twin-Bin Shelf					
	INETWBSHF-12	—	12"	—	\$91	+\$10
	INETWBSHF-14	—	14"	—	\$91	+\$10
	INETWBSHF-16	—	16"	—	\$91	+\$10
	INETWBSHF-18	—	18"	—	\$91	+\$10
	INETWBSHF-20	—	20"	—	\$91	+\$10
	Electrified Twin-Bin Whiteboard					
	INTWBWB-12	14"	12"	—	\$33	—
	INTWBWB-14	14"	14"	—	\$33	—
	INTWBWB-16	14"	16"	—	\$33	—
	INTWBWB-18	14"	18"	—	\$37	—
	INTWBWB-20	14"	20"	—	\$37	—
	Electrified Twin-Bin Power Track		8"	—	\$75	—

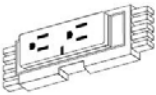





Description	Part number	Black	White	Gray
	Receptacle for use in Electrified Twin-Bin			
	IN3D1-UD-8	\$23	+\$8	+\$8
	IN3D2-UD-8	\$23	+\$8	+\$8
	IN3D3-UD-8	\$23	+\$8	+\$8
	IN3D3U-UD-8	\$23	+\$8	+\$8
	IN3D4-UD-8	\$23	+\$8	+\$8

General information

- Kit includes all components to create cavity for technology in a back to back or single sided application as specified
- End and middle units are specific to location being installed
- May only be specified with Full Height Benching Spine

Note

Make sure to option "no tile" for inside of gables as trading desk comes with tile

Description	Part number	Width	Depth	Neutral paint/ base price	Accent paint
 Back to Back 30" D End Section Kit	INTD30E42	42"	12"	\$2475	+\$248
	INTD30E48	48"	12"	\$2512	+\$252
	INTD30E54	54"	12"	\$2573	+\$258
	INTD30E60	60"	12"	\$2586	+\$259
	INTD30E72	72"	12"	\$2942	+\$295
 Back to Back 36" D End Section Kit	INTD36E42	42"	12"	\$3125	+\$313
	INTD36E48	48"	12"	\$3137	+\$314
	INTD36E54	54"	12"	\$3184	+\$319
	INTD36E60	60"	12"	\$3198	+\$320
	INTD36E72	72"	12"	\$3561	+\$357
 Single Sided 30" D End Section Kit Handed	INTDSLH30E42	42"	12"	\$1356	+\$137
	INTDSLH30E48	48"	12"	\$1362	+\$138
	INTDSLH30E54	54"	12"	\$1374	+\$139
	INTDSLH30E60	60"	12"	\$1380	+\$139
	INTDSLH30E72	72"	12"	\$1572	+\$158
	left-handed				
	INTDSRH30E42	42"	12"	\$1341	+\$135
	INTDSRH30E48	48"	12"	\$1362	+\$138
	INTDSRH30E54	54"	12"	\$1374	+\$139
	INTDSRH30E60	60"	12"	\$1380	+\$139
INTDSRH30E72	72"	12"	\$1572	+\$158	
right-handed					
 Back to Back 30" D Middle Section Kit	INTD30M42	42"	12"	\$2251	+\$226
	INTD30M48	48"	12"	\$2283	+\$229
	INTD30M54	54"	12"	\$2343	+\$235
	INTD30M60	60"	12"	\$2351	+\$236
	INTD30M72	72"	12"	\$2673	+\$268
 Back to Back 36" D Middle Section Kit	INTD36M42	42"	12"	\$2895	+\$291
	INTD36M48	48"	12"	\$2908	+\$292
	INTD36M54	54"	12"	\$2956	+\$297
	INTD36M60	60"	12"	\$2969	+\$298
	INTD36M72	72"	12"	\$3292	+\$330
 Single Sided 30" D Middle Section Kit	INTDS30M42	42"	12"	\$1218	+\$122
	INTDS30M48	48"	12"	\$1237	+\$124
	INTDS30M54	54"	12"	\$1253	+\$126
	INTDS30M60	60"	12"	\$1256	+\$126
	INTDS30M72	72"	12"	\$1428	+\$144

bench

Accessories

Left blank intentionally.

Spine Accessories are units that may be specified to sit on top of any of the benching spines. The units are specified to include the stanchion kit or not (see notes on page). Height Adjustable worksurfaces must not be specified when spine accessories are specified due to interference with the lift mechanism. The only exception to this is Add on Glazing.

Add-on glazing

Add-on Glazing is manufactured from ¼" tempered glass. A ⅜" tempered glass is also available. Glazing may be mounted to the top of any equivalent Inscape Bench spine or combination of bases outlined in the Application Guide. Glazing is available in clear, gray, etched one or two sides and designer glass Strie options. Add-on Glazing includes top trim, glass mounting extrusion and specified glass. Add-on Glazing is specified based on the thickness of the panel. **Note: Hi-lo Add-on Glazing must be specified when installed directly adjacent to a higher panel at an inline situation only.** The glaze and extrusion are inset on one side to allow for hi-lo vertical trim on the adjacent higher panel. If the situation calls for hi-lo on both sides, a special may be required. An Add on Glazing alignment clip is included with each Add on Glaze ordered in the ¼" thickness option.

Transaction tops

Transaction Tops are specific to spine width they are to be installed on. Stanchions and top trim are included in the kit, as well as a 1" thick Nuform or laminate top. Hi-Lo Transaction Top must be specified when a transaction top is specified directly adjacent to a higher panel. The worksurface takes into account the profile of the end trim.

Note: 72", 84" and 96" w kits consist of two top caps and four stanchions (based on "Symmetrical Frame Configuration" module lines). Top Caps can be specified as an option and are included with the kit.

Up-Mount bin

The Up-mount Bin is constructed of 24 gauge steel on the back and 20 gauge steel on bottom, sides and top. The Up-mount Bin is ordered and shipped independent of the stanchion kit, top trim and accessories to hang on back of bin. The stanchion kit includes hardware to mount the stanchions on the crossrail of the frame and top trim (tapered or flat). Stanchion kits are specified based on thickness of frame in which the Up-mount Bin is being installed. The backs of all Up-mount Bins require either a whiteboard or a tackboard to provide a clean aesthetic. These accessories are specific to the Up-mount Bin and include mounting hardware. The stanchion and Up-mount Bin provide an overall height of 20.25" module matching adjacent panel heights. The bin is 12.75" deep and may be specified directly adjacent to another Up-mount Bin facing the opposite direction; creating a "Twin- Bin" effect. Separate top cap and two stanchions will be required for each bin.

Open "H" leg accessories

Open "H" Leg Accessories are units which hang from the Open "H" Leg on the Inscape Bench. These units are constructed of laminate and come complete with all brackets to hang. With the exception of the Worksurface Extension and the Upper Bookcase which are not compatible with height adjustable worksurfaces, these units may be specified when a Height Adjustable worksurface is being used. The units sit 2" lower than the worksurface so there is no concern of pinch points when lowering the worksurface. The Upper Bookcase is cantilevered over the end of the worksurface (similar to the Worksurface Extension). The weight capacity of shelves is 100 lbs and all other units are 200 lbs.

Spine dividers

Spine Dividers are situated on top of the bench spine only – full height or partial. They come complete with brackets and hardware to mount on the frame as well as a top cap. Dividers may span over two frame (see application guide). Accessories for the spine divider may only be hung on the laminate and veneer versions. The tackable version is for tackability only. The two heights of divider match overall A.F.F heights of 37" and 44". Tackable Spine Divider is a 1.125" thick fabric wrapped panel.

Worksurface divider

Worksurface Divider with Accessory Rail is a 6.75" and 13.5" screen which runs perpendicular to the spine. These may only be used with bench as the depth correlates with the worksurface depth of the benching surfaces. The laminate and veneer versions allow for accessories to be hung on them, the tackable version does not. All hardware is included to mount the divider on the worksurface. It does not deface the worksurface and can be used with either 1" or 1 ¼" thick surfaces. Spine Divider Accessories have a slightly different aesthetic as Inscape System paper accessories. Accessories cannot hang on the tackboard spine divider.

Worksurface mounted corner screens

Worksurface mounted corner screens mount to main surface to provide privacy for the user. All worksurface mounted corner screens are handed left or right. The handedness is determined from the user perspective (i.e. a left handed screen would install on the left hand side of the user). The overall screen height is half way between a 44"h and a 51"h frame; 3.37" above the 44" frame height. Screens are available in two types; curved wood and metal. Both screen types have an optional feature for a tackable fabric "skin" on the inside. Screens are worksurface specific due to corner detail differences between wood and metal.

Wood curved worksurface mounted corner screens have 16 ⅞" above the worksurface and 8 ½" below. The optional fabric skin on a wood screen wraps all the way around the interior of the screen. These screens are finished in a clear coat on maple and must be mounted on a Curved Rectangular Perpendicular Worksurface.

Metal worksurface mounted corner screens can be painted any of the standard colour. The optional fabric skin on a metal screen is only on the interior back. Only metal worksurface mounted corner screens are compatible with freestanding height adjustable worksurfaces.

Upmount shelf

Upmount shelves have a transaction top style shelf with a wrap around screen. Upmount shelves can be use with either parallel or perpendicular worksurface applications. The overall height is half way between a 44"h and a 51"h frame when mounted on a Bench spine frame (3.37" above the 44" frame height) and matches the over all height of a Worksurface Mounted Corner Screen. The shelf can be optioned in Nuform and laminate. The screens are available in two types; curved wood and metal. Both screens types have an optional feature for a tackable fabric "skin" on the inside.

The curved wood screens on the upmont shelves are finished in a clear coat on maple. The optional fabric skin on a wood screen wraps all the way around the interior of the screen.

The metal screens on the upmont shelves can be painted any of the standard colour. The optional fabric skin on a metal screen is only on the interior back.

Back to back metal upmount shelves are handed left or right. The handedness is determined from the user perspective (i.e. a left handed screen would be open on the left hand side when user is looking at the spine).

Accessories

Spine Accessories

General information

- Planter box, Cubbi Stor and Transaction Counter include painted stanchions kits and trim for spine mount
- Transaction Counter is available in 1" Nuform or Laminate
- Flat trim profile only
- Cubbi Stor and Planter box are constructed of laminate
- Cubbi Stor and Planter box are not available with plywood edge band
- Cubbi Stor is 6" deep

Notes

In order to get a total cost on products when upcharges are present take the list price of the product number and add the upcharge cost shown to the list price.

For example:

Product INBTRANTOP-36 in Laminate would be \$370 \$370

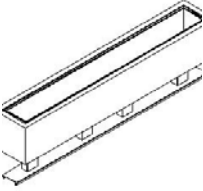
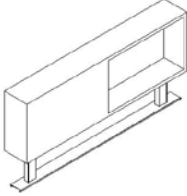
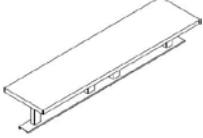

Description	Part number	Height	Width	Depth	Laminate/ neutral paint	Grade 1 laminate	Accent paint		
 Planter Box Laminate	INBPLNTTOP-36	6"	36"	6"	\$1924	+\$616	+\$193		
	INBPLNTTOP-42	6"	42"	6"	\$2038	+\$653	+\$205		
	INBPLNTTOP-48	6"	48"	6"	\$2150	+\$688	+\$216		
	INBPLNTTOP-60	6"	60"	6"	\$2263	+\$725	+\$227		
 Cubbi Stor Laminate	INBUPPCUBLH-30	13 3/8"	30"	6"	\$1816	+\$582	+\$182		
	INBUPPCUBLH-36	13 3/8"	36"	6"	\$1970	+\$631	+\$197		
	INBUPPCUBLH-42	13 3/8"	42"	6"	\$2273	+\$728	+\$228		
	INBUPPCUBLH-48	13 3/8"	48"	6"	\$2500	+\$800	+\$251		
	INBUPPCUBLH-54	13 3/8"	54"	6"	\$2592	+\$830	+\$260		
	INBUPPCUBLH-60	13 3/8"	60"	6"	\$2709	+\$867	+\$272		
	INBUPPCUBLH-72	13 3/8"	72"	6"	\$2831	+\$906	+\$284		
	INBUPPCUBRH-30	13 3/8"	30"	6"	\$1816	+\$582	+\$182		
	INBUPPCUBRH-36	13 3/8"	36"	6"	\$1970	+\$631	+\$197		
	INBUPPCUBRH-42	13 3/8"	42"	6"	\$2273	+\$728	+\$228		
	INBUPPCUBRH-48	13 3/8"	48"	6"	\$2500	+\$800	+\$251		
	INBUPPCUBRH-54	13 3/8"	54"	6"	\$2592	+\$830	+\$260		
	INBUPPCUBRH-60	13 3/8"	60"	6"	\$2709	+\$867	+\$272		
	INBUPPCUBRH-72	13 3/8"	72"	6"	\$2831	+\$906	+\$284		
Description	Part number	Height	Width	Depth	Nuform solid/ laminate	Nuform woodgrain	Grade 1 laminate	Grade 2 laminate	Accent paint
 Transaction Counter	INBTRANTOP-36	6 5/16"	36"	12"	\$370	+\$19	+\$123	+\$246	+\$38
	INBTRANTOP-42	6 5/16"	42"	12"	\$392	+\$21	+\$120	+\$239	+\$40
	INBTRANTOP-48	6 5/16"	48"	12"	\$423	+\$23	+\$129	+\$258	+\$43
	INBTRANTOP-54	6 5/16"	54"	12"	\$445	+\$24	+\$135	+\$270	+\$45
	INBTRANTOP-60	6 5/16"	60"	12"	\$450	+\$24	+\$139	+\$277	+\$46
	INBTRANTOP-72	6 5/16"	72"	12"	\$739	+\$37	+\$227	+\$452	+\$75

General information

- Up-mount overhead bins MUST always be specified to include a tackboard or whiteboard
- Up-mount bins stanchions must be specified to support a frame mounted up-mount bin
- "INB" Stanchion Kit must be used with Inscape Bench only
- Top caps included with stanchion kits and are specified to match frame and bin width
- Optional colored insert and shelf available for Up-Mount bin only
- Up-Mount shelf mounts below the Up-Mount Bin on module
- Stanchions are specific to the Bench frame and can not be used with Inscape System

Note

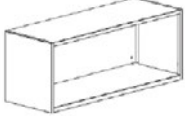
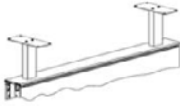
Only Expo Markers are to be used on any Inscape Whiteboard. Whiteboards should be cleaned with Expo Eraser or a Microfiber cleaning cloth along with Expo Cleaning Solution which is formulated to remove residue from Expo Dry Erase Markers.

Description	Part number	Height	Width	Depth	Neutral paint/ base price	Accent paint
 <p>Up-Mount Bin</p>	INPHUMB30	14"	30"	—	\$572	+\$58
	INPHUMB36	14"	36"	—	\$589	+\$59
	INPHUMB42	14"	42"	—	\$617	+\$62
	INPHUMB48	14"	48"	—	\$631	+\$64
	INPHUMB54	14"	54"	—	\$658	+\$66
	INPHUMB60	14"	60"	—	\$722	+\$74
 <p>Stanchion Kit for Up-Mount Bins For use with Bench spine frames</p>	INBUSKT30-2F	13 1/2"	30"	2 3/4"	\$572	+\$58
	INBUSKT36-2F	13 1/2"	36"	2 3/4"	\$589	+\$59
	INBUSKT42-2F	13 1/2"	42"	2 3/4"	\$617	+\$62
	INBUSKT48-2F	13 1/2"	48"	2 3/4"	\$631	+\$64
	INBUSKT54-2F	13 1/2"	54"	2 3/4"	\$658	+\$66
	INBUSKT60-2F	13 1/2"	60"	2 3/4"	\$722	+\$74
 <p>Colored Insert for back of bin For Up-Mounted bin only</p>	IN12INSRT30	12 1/8"	30"	—	\$94	+\$11
	IN12INSRT36	12 1/8"	36"	—	\$100	+\$11
	IN12INSRT42	12 1/8"	42"	—	\$104	+\$12
	IN12INSRT48	12 1/8"	48"	—	\$110	+\$12
 <p>Up-Mount Bin Whiteboard</p>	INUBWHB1430	14"	30"	—	\$40	—
	INUBWHB1436	14"	36"	—	\$44	—
	INUBWHB1442	14"	42"	—	\$50	—
	INUBWHB1448	14"	48"	—	\$56	—
	INUBWHB1454	14"	54"	—	\$64	—
	INUBWHB1460	14"	60"	—	\$66	—

Description	Part number	Height	Width	Grade 1/ COM	Grade 2	Grade 3	Grade 4	Grade 5	Grade 6	Grade 7	Grade 8
 <p>Up-Mount Bin Tackboard</p>	INUBTAC1430	14"	30"	\$168	+\$4	+\$9	—	+\$24	—	+\$66	—
	INUBTAC1436	14"	36"	\$171	+\$9	+\$18	—	+\$36	—	+\$89	—
	INUBTAC1442	14"	42"	\$176	+\$10	+\$19	—	+\$37	—	+\$92	—
	INUBTAC1448	14"	48"	\$181	+\$10	+\$19	—	+\$40	—	+\$99	—
	INUBTAC1454	14"	54"	\$184	+\$9	+\$21	—	+\$39	—	+\$98	—
	INUBTAC1460	14"	60"	\$190	+\$7	+\$18	—	+\$38	—	+\$98	—

Accessories

Spine Accessories

Up-Mount Bins

General information

- 3/8" top is installation ready, complete with double sided tape for adhesion to case
- Sliding door must be mounted on two up-mount bins of equal size that are side by side

Description	Part number	Width	Depth	Nuform solid	Nuform woodgrain pattern
 3/8" T Up-Mount Bin Top	PHUMBTOP-1330	30"	13"	\$162	+\$16
	PHUMBTOP-1336	36"	13"	\$192	+\$13
	PHUMBTOP-1342	42"	13"	\$212	+\$23
	PHUMBTOP-1348	48"	13"	\$235	+\$25
	PHUMBTOP-1354	54"	13"	\$259	+\$26
	PHUMBTOP-1360	60"	13"	\$284	+\$29
	PHUMBTOP-1372	72"	13"	\$373	+\$37
	PHUMBTOP-1384	84"	13"	\$417	+\$40
	PHUMBTOP-1396	96"	13"	\$458	+\$46

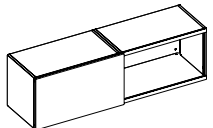
Description	Part number	Width	Nuform solid/laminate	Grade 1 laminate	Veneer
 Sliding Door & Track Up-Mount bin specified separately	INUMBSLDR30	30"	\$491	+\$158	+\$135
	INUMBSLDR36	36"	\$505	+\$162	+\$165
	INUMBSLDR42	42"	\$513	+\$165	+\$196
	INUMBSLDR48	48"	\$527	+\$169	+\$223

General information

- Add-on Glazing comes complete with mounting hardware and top cap
- Add-on Glazing may span multiple frames according to guidelines set in the Inscape Bench Application Guide
- 10.125" T glaze available in .25" T
- One glaze Alignment clip is included with each Add on Glazing
- Add-on Glazing up to 60" w require two additional Jesters to be specified if spanning multiple frames (ie a 60" w AOG installed on 2-30" frames)
- **List/Base for 0.25" thick is clear glass**



Notes

In order to get a total cost on products when upcharges are present take the list price of the product number and add the upcharge cost shown to the list price.

For example:

Product INAG6.7530-2F 0.25" thick glass with Gray would be \$195 +\$94

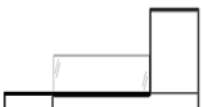
The same product upgraded to 0.38" thick glass would be \$195 +\$97 +\$236

Description	Part number	Width	List/base 0.25" thick glazing price	Glazing thickness option	0.25" thick finish options				0.38" thick finish options			
				0.38" thick glazing	Clear	Gray	Etched 1 side	Etched 2 side	Clear	Gray	Etched 1 side	Accent paint
 6.75" H Add-On Glazing For use with 2 3/4" T frames	INAG6.7530-2F	30"	\$195	+\$97	\$0	+\$94	+\$94	+\$185	+\$0	+\$236	+\$236	+\$21
	INAG6.7536-2F	36"	\$215	+\$106	\$0	+\$102	+\$102	+\$226	+\$0	+\$257	+\$257	+\$23
	INAG6.7542-2F	42"	\$230	+\$114	\$0	+\$106	+\$106	+\$234	+\$0	+\$270	+\$270	+\$24
	INAG6.7548-2F	48"	\$248	+\$121	\$0	+\$110	+\$110	+\$239	+\$0	+\$286	+\$286	+\$26
	INAG6.7554-2F	54"	\$265	+\$131	\$0	+\$113	+\$113	+\$243	+\$0	+\$298	+\$298	+\$28
	INAG6.7560-2F	60"	\$286	+\$141	\$0	+\$125	+\$125	+\$269	+\$0	+\$327	+\$327	+\$30
	INAG6.7566-2F	66"	\$296	+\$145	\$0	+\$155	+\$155	+\$292	+\$0	+\$377	+\$377	+\$31
	INAG6.7572-2F	72"	\$311	+\$154	\$0	+\$172	+\$172	+\$320	+\$0	+\$410	+\$410	+\$32
	INAG6.7578-2F	78"	\$397	+\$194	\$0	+\$133	+\$133	+\$274	+\$0	+\$394	+\$394	+\$41
	INAG6.7584-2F	84"	\$464	+\$228	\$0	+\$111	+\$111	+\$245	+\$0	+\$394	+\$394	+\$47
 6.75" H Hi-Lo Add-On Glazing For use with 2 3/4" T frames	INAGHL6.7530-2F	30"	\$195	+\$97	\$0	+\$94	+\$94	+\$185	+\$0	+\$236	+\$236	+\$21
	INAGHL6.7536-2F	36"	\$215	+\$106	\$0	+\$102	+\$102	+\$226	+\$0	+\$257	+\$257	+\$23
	INAGHL6.7542-2F	42"	\$230	+\$114	\$0	+\$106	+\$106	+\$234	+\$0	+\$270	+\$270	+\$24
	INAGHL6.7548-2F	48"	\$248	+\$121	\$0	+\$110	+\$110	+\$239	+\$0	+\$286	+\$286	+\$26
	INAGHL6.7554-2F	54"	\$265	+\$131	\$0	+\$113	+\$113	+\$243	+\$0	+\$298	+\$298	+\$28
	INAGHL6.7560-2F	60"	\$286	+\$141	\$0	+\$125	+\$125	+\$269	+\$0	+\$327	+\$327	+\$30
	INAGHL6.7566-2F	66"	\$296	+\$145	\$0	+\$155	+\$155	+\$292	+\$0	+\$377	+\$377	+\$31
	INAGHL6.7572-2F	72"	\$311	+\$154	\$0	+\$172	+\$172	+\$320	+\$0	+\$410	+\$410	+\$32
	INAGHL6.7578-2F	78"	\$397	+\$194	\$0	+\$133	+\$133	+\$274	+\$0	+\$394	+\$394	+\$41
	INAGHL6.7584-2F	84"	\$464	+\$228	\$0	+\$111	+\$111	+\$245	+\$0	+\$394	+\$394	+\$47
 10.125" H Add-On Glazing For use with 2 3/4" T frames	INAG10.12530-2F	30"	\$196	+\$115	\$0	+\$96	+\$96	+\$186	+\$0	+\$176	+\$176	+\$21
	INAG10.12536-2F	36"	\$219	+\$117	\$0	+\$109	+\$109	+\$225	+\$0	+\$179	+\$179	+\$23
	INAG10.12542-2F	42"	\$240	+\$120	\$0	+\$119	+\$119	+\$247	+\$0	+\$182	+\$182	+\$25
	INAG10.12548-2F	48"	\$261	+\$138	\$0	+\$132	+\$132	+\$269	+\$0	+\$207	+\$207	+\$27
	INAG10.12554-2F	54"	\$282	+\$155	\$0	+\$143	+\$143	+\$289	+\$0	+\$233	+\$233	+\$29
	INAG10.12560-2F	60"	\$306	+\$161	\$0	+\$159	+\$159	+\$321	+\$0	+\$247	+\$247	+\$32
	INAG10.12566-2F	66"	\$324	+\$173	\$0	+\$183	+\$183	+\$346	+\$0	+\$268	+\$268	+\$33
	INAG10.12572-2F	72"	\$361	+\$186	\$0	+\$182	+\$182	+\$348	+\$0	+\$290	+\$290	+\$37
	INAG10.12578-2F	78"	\$432	+\$199	\$0	+\$156	+\$156	+\$318	+\$0	+\$311	+\$311	+\$44
	INAG10.12584-2F	84"	\$495	+\$213	\$0	+\$140	+\$140	+\$293	+\$0	+\$333	+\$333	+\$50
 10.125" H Hi-Lo Add-On Glazing For use with 2 3/4" T frames	INAGHL10.130-2F	30"	\$196	+\$115	\$0	+\$96	+\$96	+\$186	+\$0	+\$176	+\$176	+\$21
	INAGHL10.136-2F	36"	\$219	+\$117	\$0	+\$109	+\$109	+\$225	+\$0	+\$179	+\$179	+\$23
	INAGHL10.142-2F	42"	\$240	+\$120	\$0	+\$119	+\$119	+\$225	+\$0	+\$182	+\$182	+\$25
	INAGHL10.148-2F	48"	\$261	+\$138	\$0	+\$132	+\$132	+\$269	+\$0	+\$207	+\$207	+\$27
	INAGHL10.154-2F	54"	\$282	+\$155	\$0	+\$143	+\$143	+\$289	+\$0	+\$233	+\$233	+\$29
	INAGHL10.160-2F	60"	\$306	+\$161	\$0	+\$159	+\$159	+\$321	+\$0	+\$247	+\$247	+\$32
	INAGHL10.166-2F	66"	\$324	+\$173	\$0	+\$183	+\$183	+\$346	+\$0	+\$268	+\$268	+\$33
	INAGHL10.172-2F	72"	\$361	+\$186	\$0	+\$182	+\$182	+\$348	+\$0	+\$290	+\$290	+\$37
	INAGHL10.178-2F	78"	\$432	+\$199	\$0	+\$156	+\$156	+\$318	+\$0	+\$311	+\$311	+\$44
	INAGHL10.184-2F	84"	\$495	+\$213	\$0	+\$140	+\$140	+\$293	+\$0	+\$333	+\$333	+\$50
INAGHL10.190-2F	90"	\$559	+\$225	\$0	+\$119	+\$119	+\$269	+\$0	+\$355	+\$355	+\$56	
INAGHL10.196-2F	96"	\$625	+\$237	\$0	+\$102	+\$102	+\$246	+\$0	+\$377	+\$377	+\$63	

Accessories

Spine Accessories

Add-on Glazing

General information

- Add-on Glazing comes complete with mounting hardware and top cap
- Add-on Glazing may span multiple frames according to guidelines set in the Inscape Bench Application Guide
- 10.125" T glaze available in .25" T
- One glaze Alignment clip is included with each Add on Glazing
- Add-on Glazing up to 60"w require two additional Jesters to be specified if spanning multiple frames (ie a 60"w AOG installed on 2-30" frames)
- **List/Base for 0.25" thick is clear glass**

Notes

In order to get a total cost on products when upcharges are present take the list price of the product number and add the upcharge cost shown to the list price.

For example:

Product INAG13.530-2F 0.25" thick glass with Gray would be \$197 +\$97

The same product upgraded to 0.38" thick glass would be \$197 +\$98 +\$240

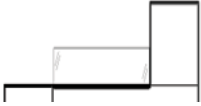
Description	Part number	Width	List/base /0.25" thick glazing price	Glazing thickness option	0.25" thick finish options				0.38" thick finish options			Accent paint
				0.38" thick glazing	Clear	Gray	Etched 1 side	Etched 2 side	Clear	Gray	Etched 1 side	
 <p>13.5" H Add-On Glazing For use with 2 3/4" T frames</p>	INAG13.530-2F	30"	\$197	+\$98	\$0	+\$97	+\$97	+\$186	+\$0	+\$240	+\$240	+\$21
	INAG13.536-2F	36"	\$223	+\$110	\$0	+\$115	+\$115	+\$224	+\$0	+\$282	+\$282	+\$23
	INAG13.542-2F	42"	\$249	+\$123	\$0	+\$134	+\$134	+\$261	+\$0	+\$323	+\$323	+\$26
	INAG13.548-2F	48"	\$275	+\$135	\$0	+\$154	+\$154	+\$298	+\$0	+\$366	+\$366	+\$28
	INAG13.554-2F	54"	\$301	+\$148	\$0	+\$172	+\$172	+\$333	+\$0	+\$404	+\$404	+\$31
	INAG13.560-2F	60"	\$327	+\$161	\$0	+\$191	+\$191	+\$371	+\$0	+\$447	+\$447	+\$34
	INAG13.566-2F	66"	\$352	+\$173	\$0	+\$212	+\$212	+\$400	+\$0	+\$488	+\$488	+\$36
	INAG13.572-2F	72"	\$409	+\$199	\$0	+\$191	+\$191	+\$409	+\$0	+\$487	+\$487	+\$42
	INAG13.578-2F	78"	\$466	+\$229	\$0	+\$180	+\$180	+\$359	+\$0	+\$497	+\$497	+\$47
	INAG13.584-2F	84"	\$526	+\$258	\$0	+\$169	+\$169	+\$341	+\$0	+\$510	+\$510	+\$53
	INAG13.590-2F	90"	\$584	+\$288	\$0	+\$150	+\$150	+\$323	+\$0	+\$510	+\$510	+\$59
INAG13.596-2F	96"	\$644	+\$318	\$0	+\$138	+\$138	+\$302	+\$0	+\$521	+\$521	+\$65	
 <p>13.5" H Hi-Lo Add- On Glazing For use with 2 3/4" T frames</p>	INAGHL13.530-2F	30"	\$197	+\$98	\$0	+\$97	+\$97	+\$186	+\$0	+\$240	+\$240	+\$21
	INAGHL13.536-2F	36"	\$223	+\$110	\$0	+\$115	+\$115	+\$224	+\$0	+\$282	+\$282	+\$23
	INAGHL13.542-2F	42"	\$249	+\$123	\$0	+\$134	+\$134	+\$261	+\$0	+\$323	+\$323	+\$26
	INAGHL13.548-2F	48"	\$275	+\$135	\$0	+\$154	+\$154	+\$298	+\$0	+\$366	+\$366	+\$28
	INAGHL13.554-2F	54"	\$301	+\$148	\$0	+\$172	+\$172	+\$333	+\$0	+\$404	+\$404	+\$31
	INAGHL13.560-2F	60"	\$327	+\$161	\$0	+\$191	+\$191	+\$371	+\$0	+\$447	+\$447	+\$34
	INAGHL13.566-2F	66"	\$352	+\$173	\$0	+\$212	+\$212	+\$400	+\$0	+\$488	+\$488	+\$36
	INAGHL13.572-2F	72"	\$409	+\$199	\$0	+\$191	+\$191	+\$409	+\$0	+\$487	+\$487	+\$42
	INAGHL13.578-2F	78"	\$466	+\$229	\$0	+\$180	+\$180	+\$359	+\$0	+\$497	+\$497	+\$47
	INAGHL13.584-2F	84"	\$526	+\$258	\$0	+\$169	+\$169	+\$341	+\$0	+\$510	+\$510	+\$53
	INAGHL13.590-2F	90"	\$584	+\$288	\$0	+\$150	+\$150	+\$323	+\$0	+\$510	+\$510	+\$59
INAGHL13.596-2F	96"	\$644	+\$318	\$0	+\$138	+\$138	+\$302	+\$0	+\$521	+\$521	+\$65	

General information

- For use with Inscape Bench only
- Includes hardware and top cap
- Same rules as other spanning components - spanning over two frames only (see application guide)
- Laminate divider accessories are compatible with this divider
- Dividers are not compatible with System Horizontal accessories
- These items are not available with plywood edge banding

Notes

In order to get a total cost on products when upcharges are present take the list price of the product number and add the upcharge cost shown to the list price.

For example:

Product INBAP1036 in Veneer would be \$477 +\$172

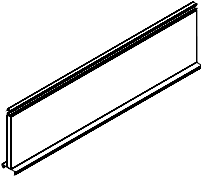
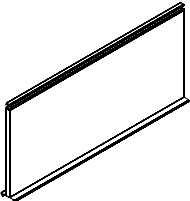
Description	Part number	Height	Width	Thickness)	Laminate/ base price	Grade 1 laminate	Veneer	Accent paint
 <p>10.125" H Spine Divider with Accessory Rail To match 37" H Frame Height</p>	INBAP1036	10.125"	36"	3/4"	\$477	+\$153	+\$172	+\$48
	INBAP1042	10.125"	42"	3/4"	\$536	+\$172	+\$168	+\$54
	INBAP1048	10.125"	48"	3/4"	\$573	+\$184	+\$168	+\$58
	INBAP1054	10.125"	54"	3/4"	\$602	+\$193	+\$218	+\$61
	INBAP1060	10.125"	60"	3/4"	\$666	+\$214	+\$198	+\$67
	INBAP1066	10.125"	66"	3/4"	\$743	+\$238	+\$243	+\$76
	INBAP1072	10.125"	72"	3/4"	\$864	+\$277	+\$167	+\$88
	INBAP1078	10.125"	78"	3/4"	\$893	+\$286	+\$216	+\$90
	INBAP1084	10.125"	84"	3/4"	\$896	+\$287	+\$258	+\$91
	INBAP1090	10.125"	90"	3/4"	\$898	+\$288	+\$301	+\$91
INBAP1096	10.125"	96"	3/4"	\$901	+\$289	+\$345	+\$91	
 <p>16.875" H Spine Divider with Accessory Rail To match 44" H Frame Height and 13.5" H Laminate Worksurface Divider Panel with Accessory Rail</p>	INBAP1636	16.875"	36"	3/4"	\$512	+\$164	+\$379	+\$52
	INBAP1642	16.875"	42"	3/4"	\$605	+\$194	+\$369	+\$61
	INBAP1648	16.875"	48"	3/4"	\$600	+\$192	+\$443	+\$61
	INBAP1654	16.875"	54"	3/4"	\$794	+\$255	+\$351	+\$81
	INBAP1660	16.875"	60"	3/4"	\$798	+\$256	+\$422	+\$81
	INBAP1666	16.875"	66"	3/4"	\$873	+\$280	+\$492	+\$88
	INBAP1672	16.875"	72"	3/4"	\$876	+\$281	+\$568	+\$89
	INBAP1678	16.875"	78"	3/4"	\$1068	+\$342	+\$476	+\$108
	INBAP1684	16.875"	84"	3/4"	\$1070	+\$343	+\$547	+\$108
	INBAP1690	16.875"	90"	3/4"	\$1073	+\$344	+\$546	+\$108
INBAP1696	16.875"	96"	3/4"	\$1076	+\$345	+\$617	+\$108	

Accessories

Spine Accessories

Spine Tackable Divider

General information

- For use with Inscape Bench only
- 1.125" thick soft feel fabric wrapped tackboard panel
- Includes hardware and top cap
- Laminate divider accessories are not compatible with this panel

Notes

In order to get a total cost on products when upcharges are present take the list price of the product number and add the upcharge cost shown to the list price.

For example:



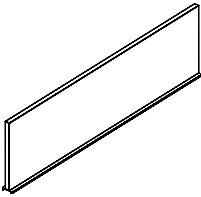

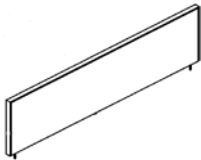

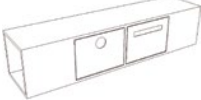

Product INBAPF1636 in Grade C would be \$708 +\$243

Description	Part number	Height	Width	Thickness)	Grade A	Grade B/ COM	Grade C	Grade D	Grade E	Grade F	Accent paint upcharge
 <p>16.875" H Spine Tackable Divider To match 44" H Frame Height and 13.5" H Worksurface Tackable Divider</p>	INBAPF1636	16.875"	36"	1 1/8"	\$708	+\$128	+\$243	+\$318	+\$384	+\$548	+\$72
	INBAPF1642	16.875"	42"	1 1/8"	\$755	+\$149	+\$258	+\$370	+\$446	+\$637	+\$77
	INBAPF1648	16.875"	48"	1 1/8"	\$806	+\$144	+\$257	+\$408	+\$495	+\$712	+\$82
	INBAPF1660	16.875"	60"	1 1/8"	\$904	+\$236	+\$382	+\$500	+\$607	+\$878	+\$91
	INBAPF1666	16.875"	66"	1 1/8"	\$976	+\$222	+\$458	+\$565	+\$685	+\$981	+\$99
	INBAPF1672	16.875"	72"	1 1/8"	\$1036	+\$164	+\$414	+\$531	+\$660	+\$673	+\$104
	INBAPF1684	16.875"	84"	1 1/8"	\$1149	+\$198	+\$458	+\$595	+\$747	+\$1123	+\$116
	INBAPF1696	16.875"	96"	1 1/8"	\$1328	+\$293	+\$543	+\$706	+\$877	+\$1309	+\$133

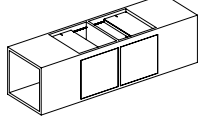
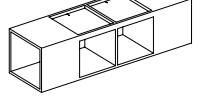
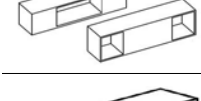
Description	Part number	Height	Width	Weight (lbs)	Grade 1/ COM	Grade 2	Grade 3	Grade 4	Grade 5	Grade 6	Grade 7	Grade 8	Accent paint upcharge
 <p>16.875" H Rectangular Framed Spine Divider, Tackable To match 44" H Frame Height</p>	INBRFD1630	16.875"	30"	2 3/4"	\$666	+\$5	+\$17	+\$25	+\$33	+\$54	+\$75	+\$103	+\$67
	INBRFD1636	16.875"	36"	2 3/4"	\$736	+\$6	+\$18	+\$28	+\$37	+\$61	+\$85	+\$118	+\$74
	INBRFD1642	16.875"	42"	2 3/4"	\$806	+\$6	+\$12	+\$25	+\$37	+\$62	+\$87	+\$121	+\$82
	INBRFD1648	16.875"	48"	2 3/4"	\$827	+\$8	+\$24	+\$34	+\$44	+\$73	+\$99	+\$139	+\$83
	INBRFD1654	16.875"	54"	2 3/4"	\$892	+\$8	+\$26	+\$38	+\$50	+\$81	+\$110	+\$153	+\$90
	INBRFD1660	16.875"	60"	2 3/4"	\$898	+\$10	+\$36	+\$49	+\$63	+\$94	+\$125	+\$175	+\$90

General information

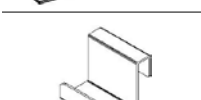
- Lower units are hung from the Open H or O Leg
- Lower units may be specified when a Height Adjustable worksurface is installed
- Upper bookcase may not specified adjacent to a Height Adjustable worksurface
- Accessories are constructed of laminate
- Specify units based on width of the bench
- Shelves, hook and acrylic modesty hang from the Open H or O Leg
- These items are not available with plywood edge banding

Description	Part number	Height	Width	Depth	Laminate/ base price	Grade 1 laminate	Accent paint	
	Lower Bookcase with Recycling and Garbage	INBLWRBREC-48	14.011"	51 1/2"	15"	\$3565	+\$1141	+\$358
	Laminate case with metal door fronts	INBLWRBREC-60	14.011"	63 1/2"	15"	\$3847	+\$1232	+\$385
		INBLWRBREC-72	14.011"	75 1/2"	15"	\$4185	+\$1340	+\$420
	Lower Bookcase	INBLWRBOOK-48	14.011"	51 1/2"	15"	\$3281	+\$1050	+\$329
		INBLWRBOOK-60	14.011"	63 1/2"	15"	\$3621	+\$1159	+\$363
		INBLWRBOOK-72	14.011"	75 1/2"	15"	\$3960	+\$1268	+\$397
	Lower Bookcase with Personal Centre	INBLWRBPERS-48	14.011"	51 1/2"	15"	\$4300	+\$1376	+\$431
		INBLWRBPERS-60	14.011"	63 1/2"	15"	\$4752	+\$1521	+\$477
		INBLWRBPERS-72	14.011"	75 1/2"	15"	\$5091	+\$1630	+\$510
	Personalized Side Access Bookcase	INBLWRPERSA-48	14.011"	51 1/2"	15"	\$3136	+\$1004	+\$314
		INBLWRPERSA-60	14.011"	63 1/2"	15"	\$3708	+\$1187	+\$372
		INBLWRPERSA-72	14.011"	75 1/2"	15"	\$4215	+\$1349	+\$423
	Upper Bookcase	INBUPPBOOK-48	14.011"	51 1/2"	15"	\$3281	+\$1050	+\$329
		INBUPPBOOK-60	14.011"	63 1/2"	15"	\$3621	+\$1159	+\$363
		INBUPPBOOK-72	14.011"	75 1/2"	15"	\$3960	+\$1268	+\$397
	Lower Bookcase with Glazed Sliding Panel	INBLWRBSLID-48	14.011"	51 1/2"	15"	\$3281	+\$1050	+\$329
	white or frosted panel options available	INBLWRBSLID-60	14.011"	63 1/2"	15"	\$3621	+\$1159	+\$363
		INBLWRBSLID-72	14.011"	75 1/2"	15"	\$3847	+\$1232	+\$385
	Planter Box	INBPLNTEND-48	6"	51 1/2"	6"	\$2150	+\$688	+\$216
		INBPLNTEND-60	6"	63 1/2"	6"	\$2377	+\$761	+\$239
		INBPLNTEND-72	6"	75 1/2"	6"	\$2603	+\$833	+\$261
	Shelf	INBSHELF-48	14.011"	51 1/2"	13"	\$1359	+\$435	+\$137
		INBSHELF-60	14.011"	63 1/2"	13"	\$1472	+\$472	+\$148
		INBSHELF-72	14.011"	75 1/2"	13"	\$1585	+\$508	+\$160
	Shelf with Planter	INBSHELFPLT-48	14.011"	51 1/2"	13"	\$3507	+\$1123	+\$352
		INBSHELFPLT-60	14.011"	63 1/2"	13"	\$3735	+\$1196	+\$374
		INBSHELFPLT-72	14.011"	75 1/2"	13"	\$3960	+\$1268	+\$397
	Open Leg Accessory Hook	INBAHOOK	—	—	—	\$63	—	+\$8

Accessories

Open leg Accessories

General information

- Worksurface Extension are mounted to the surface and may not specified when a Height Adjustable worksurface is installed
- Woodgrain pattern when applied on Worksurface Extension will run perpendicularly to main worksurfaces
- Worksurface Extension only to be used with Open H and O Leg end support
- Shelves, hooks hang from the Open H or O Leg; however acrylic modesty is sized to fit H Leg only
- Acrylic modesty and privacy screens may be specified when a Height Adjustable worksurface is installed
- Acrylic modesty and privacy screens can be use with both H Legs and O Legs (when no glazed insert is optioned)
- Acrylic - white and frosted one side only

Notes

In order to get a total cost on products when upcharges are present take the list price of the product number and add the upcharge cost shown to the list price.

For example:

Product INBWX1848 in Grade 2 Laminate would be \$499 +\$423

Description	Part number	Height	Depth	Straight edge nuform solid laminate	Nuform woodgrain pattern	Nuform tapered edge	Grade 1 laminate	Grade 2 laminate	Veneer	Accent paint
	INBWX1848	51 1/2"	18"	\$499	+\$39	+\$19	+\$160	+\$423	+\$843	+\$51
	INBWX1860	63 1/2"	18"	\$566	+\$48	+\$26	+\$182	+\$438	+\$874	+\$57
	INBWX1872	75 1/2"	18"	\$696	+\$58	+\$29	+\$223	+\$436	+\$870	+\$71

Worksurface Extension

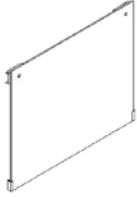
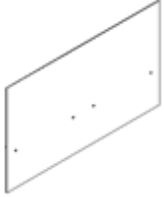
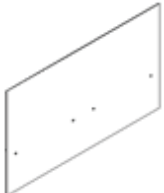
Description	Part number	Height	Width	White	Frosted	Accent paint	
	Acrylic Modesty Panel for use with H Leg only	INBAMP-24	24 1/6"	22 4/5"	\$431	+\$431	+\$44
		INBAMP-30	24 1/6"	28 4/5"	\$504	+\$504	+\$51
		INBAMP-36	24 1/6"	34 4/5"	\$577	+\$577	+\$58
	Acrylic Privacy Screen For privacy Matches 44" H overall	INBAPS-1948	18 9/8"	50 3/4"	\$645	+\$645	+\$65
		INBAPS-1960	18 9/8"	62 3/4"	\$721	+\$721	+\$73
		INBAPS-1972	18 9/8"	74 3/4"	\$798	+\$798	+\$81
	Acrylic Privacy Screen For modesty and privacy Matches 44" H overall	INBAPS-2948	28 3/4"	50 3/4"	\$816	+\$816	+\$83
		INBAPS-2960	28 3/4"	62 3/4"	\$857	+\$857	+\$87
		INBAPS-2972	28 3/4"	74 3/4"	\$1048	+\$1048	+\$106

General information

- For use with Inscape Bench only
- Tackable divider is a 1.125" thick fabric wrapped tackboard panel
- Laminate divider accessories are not compatible with tackable divider
- Dividers Include hardware to mount worksurface perpendicular to spine
- Divider Screen for straight edge worksurfaces are available in a mid or end application option
- The end application Divider Screen can also be used on a height adjustable worksurfaces
- Divider Screen specific to tapered edge worksurfaces is 2" shorter than width stated to accommodate tapered edge and is easier to move

Notes

In order to get a total cost on products when upcharges are present take the list price of the product number and add the upcharge cost shown to the list price.

For example:

Product INBSDPF1324 in Grade C would be \$490 +\$180

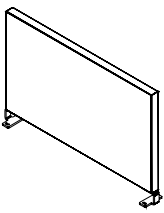
Description	Part number	Height	Width	Thickness	Grade A	Grade B /COM	Grade C	Grade D	Grade E	Grade F	Accent paint
	INBSDPF1324	13.5"	24"	1 1/8"	\$490	+\$108	+\$180	+\$251	+\$296	+\$406	+\$50
	INBSDPF1330	13.5"	30"	1 1/8"	\$540	+\$111	+\$225	+\$292	+\$347	+\$484	+\$55
	INBSDPF1336	13.5"	36"	1 1/8"	\$578	+\$131	+\$264	+\$345	+\$410	+\$575	+\$58

13.5" H Worksurface Tackable Divider for Mid Application
With mounting brackets on front and back
For use with straight edge worksurfaces
Matches 44" H panel and 16.875" H Spine
Tackable Divider

	INBSDPFED1324	13.5"	24"	1 1/8"	\$490	+\$108	+\$180	+\$251	+\$296	+\$406	+\$50
	INBSDPFED1330	13.5"	30"	1 1/8"	\$540	+\$111	+\$225	+\$292	+\$347	+\$484	+\$55
	INBSDPFED1336	13.5"	36"	1 1/8"	\$578	+\$131	+\$264	+\$345	+\$410	+\$575	+\$58

13.5" H Worksurface Tackable Divider for End Application
With mounting brackets on front and back
For use with straight edge worksurfaces
Matches 44" H panel and 16.875" H Spine
Tackable Divider

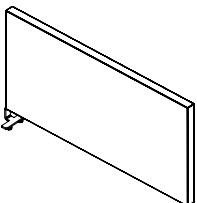
	INBSDSF1324	13.5"	24"	1 1/8"	\$452	+\$123	+\$176	+\$258	+\$300	+\$401	+\$46
	INBSDSF1330	13.5"	30"	1 1/8"	\$512	+\$120	+\$236	+\$289	+\$341	+\$469	+\$52
	INBSDSF1336	13.5"	36"	1 1/8"	\$549	+\$142	+\$268	+\$344	+\$405	+\$561	+\$55

13.5" H Worksurface Tackable Divider
With single bracket to be mount at back of surface only
For use with tapered edge worksurfaces
Matches 44" H panel and 16.875" H Spine
Tackable Divider

General information



- For use with Inscape Bench only
- Laminate divider accessories are compatible with this divider
- Dividers Include hardware to mount worksurface perpendicular to spine
- Divider Screen for straight edge worksurfaces are available in a mid or end application option
- The end application Divider Screen can also be used on a height adjustable worksurfaces
- Divider Screen specific to tapered edge worksurfaces is 2" shorter than width stated to accommodate tapered edge and is easier to move
- Dividers are not compatible with System Horizontal accessories
- These items are not available with plywood edge banding

Notes

In order to get a total cost on products when upcharges are present take the list price of the product number and add the upcharge cost shown to the list price.

For example:

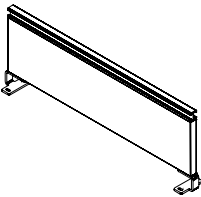
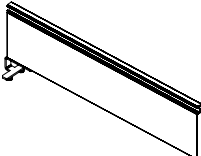
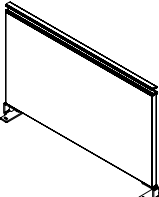
Product INBSDP624 in Veneer would be \$315 +\$43

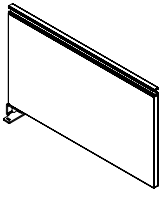
Description	Part number	Height	Width	Thickness	Laminate/ base price	Grade 1 laminate	Veneer	Accent paint
 6.75" H Worksurface Divider with Accessory Rail With mounting brackets on front and back For use with straight edge worksurfaces Matches 37" H panel & 10.125" H Add-On Panel and Glazing	INBSDP624	6.75"	24"	¾"	\$315	+\$101	+\$43	+\$32
	INBSDP630	6.75"	30"	¾"	\$337	+\$108	+\$46	+\$35
	INBSDP636	6.75"	36"	¾"	\$363	+\$117	+\$50	+\$37
 6.75" H Worksurface Divider Panel with Accessory Rail With single bracket to be mount at back of surface only For use with tapered edge worksurfaces Matches 37" H panel & 10.125" H Add-On Panel and Glazing	INBSDS624	6.75"	24"	¾"	\$353	+\$113	+\$43	+\$36
	INBSDS630	6.75"	30"	¾"	\$373	+\$120	+\$46	+\$38
	INBSDS636	6.75"	36"	¾"	\$390	+\$125	+\$50	+\$40
 13.5" H Worksurface Divider with Accessory Rail for Mid Application With mounting brackets on front and back For use with straight edge worksurfaces Matches 44" H panel and 16.875" H Spine Divider with Accessory Rail	INBSDP1324	13.5"	24"	¾"	\$348	+\$112	+\$162	+\$36
	INBSDP1330	13.5"	30"	¾"	\$374	+\$120	+\$173	+\$38
	INBSDP1336	13.5"	36"	¾"	\$401	+\$129	+\$186	+\$41
 13.5" H Worksurface Divider with Accessory Rail for End Application With mounting brackets on front and back For use with straight edge worksurfaces Matches 44" H panel and 16.875" H Spine Divider with Accessory Rail	INBSDPED1324	13.5"	24"	¾"	\$348	+\$112	+\$162	+\$36
	INBSDPED1330	13.5"	30"	¾"	\$374	+\$120	+\$173	+\$38
	INBSDPED1336	13.5"	36"	¾"	\$401	+\$129	+\$186	+\$41
 13.5" H Worksurface Divider Panel with Accessory Rail With single bracket to be mount at back of surface only For use with tapered edge worksurfaces Matches 44" H panel and 16.875" H Spine Divider with Accessory Rail	INBSDS1324	13.5"	24"	¾"	\$408	+\$131	+\$162	+\$42
	INBSDS1330	13.5"	30"	¾"	\$433	+\$139	+\$173	+\$44
	INBSDS1336	13.5"	36"	¾"	\$459	+\$147	+\$186	+\$47

General information

- Accessories do not hang on the tackable version of the dividers
- Slightly different design detail from Inscape System paper trays

Notes

In order to get a total cost on products when upcharges are present take the list price of the product number and add the upcharge cost shown to the list price.

For example:

Product INBTTS1330 in Grade 5 would be \$333 +\$21

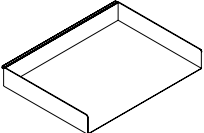
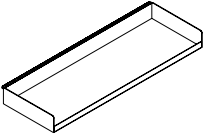
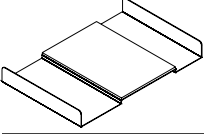
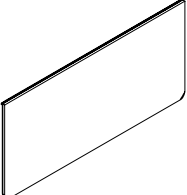
Description	Part number	Height	Width	Depth	Neutral paint/ base price	Accent paint
 Paper Tray No holes in bottom	INBAPTRY	2"	12"	9"	\$72	+\$8
 Personal Accessory Tray	INBAPSHF	2"	18"	6"	\$108	+\$12
 Personal Accessory Tray Divider with Felt Pad For use with Personal Accessory Tray	INBAPSHFDV	—	—	—	\$85	+\$10
	INBTMS1330	13"	30"	—	\$214	+\$22
	INBTMS1336	13"	36"	—	\$236	+\$25
	INBTMS1342	13"	42"	—	\$259	+\$27
	INBTMS1348	13"	48"	—	\$282	+\$29

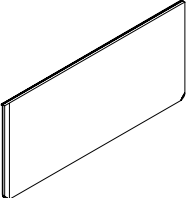
Description	Part number	Height	Width	Grade 1/ COM	Grade 2	Grade 3	Grade 4	Grade 5	Grade 6	Grade 7	Grade 8	Accent paint
	INBTTS1330	13"	30"	\$333	+\$5	+\$10	—	+\$21	—	+\$52	—	+\$34
	INBTTS1336	13"	36"	\$357	+\$8	+\$17	—	+\$37	—	+\$80	—	+\$37
	INBTTS1342	13"	42"	\$381	+\$9	+\$18	—	+\$38	—	+\$84	—	+\$39
	INBTTS1348	13"	48"	\$405	+\$11	+\$20	—	+\$39	—	+\$84	—	+\$41

Accessory Rail
Tackboard

Bench

Accessories

Collaborative Collection

General information

- For use with Inscape Bench only
- The chair matches an adjacent worksurface depth of 30" and the sled style legs are available in all paint colors
- Different brackets are optioned depending on which type of surface is adjacent to the chair; fixed height, electric height adjustable or freestanding height adjustable
- Remember to order adjacent worksurface supports separately
- The chair can NOT be used with manual height adjustable worksurfaces
- Table base is available in all paint colors
- The table and shelf sit flush with the spine top cap
- The table and shelf have straight fronts and backs with curved sides. They are available in 1¼" thick Nuform and laminate options only
- Shelf brackets are available in all paint colors
- 72" w spine space = Two chairs with shelf
- 84" w spine space = Two chairs with shelf or table
- 8" clearance under the shelf for legs when seated in chair

Notes



In order to get a total cost on products when upcharges are present take the list price of the product number and add the upcharge cost shown to the list price.

For example:

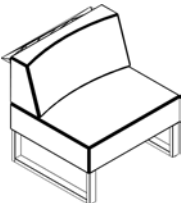
Product INBCLBCHAIR in Grade D would be \$2660 +\$772

Description	Part number	Height	Width	Depth	Fabric options						Accent paint
					Grade A/ COM	Grade B	Grade C	Grade D	Grade E	Grade F	
	INBCLBCHAIR	29 ½"	29 ¾"	25 ½"	\$2660	+\$236	+\$604	+\$772	+\$914	+\$1168	+\$266
					Worksurface support options						
					Product number	Fixed height	Freestanding Height Adjustable	Electric Height Adjustable			
					INBCLBCHAIR	+\$82	+\$0	+\$0			

Collaborative Chair

Description	Part number	Height	Width	Depth	Nuform solid/ laminate/ woodgrain/pattern		Grade 1 laminate	Accent paint
	INBCLBTBL	26"	33 ¾"	29 ¾"	\$1320	+\$66	+\$423	+\$132
	INBCLBSHELF	26"	27 ¼"	10"	\$528	+\$26	+\$169	+\$53

Collaborative Table

Collaborative Shelf

General information

- For use with perpendicular worksurface applications only
- Screens and shelves (both metal and wood) have an OPTIONAL feature for a tackable fabric "skin" on the inside. Base price is without skin
- The fabric skin on the wood screens wraps all the way around the interior of the screen. On metal screens it is only on interior back
- All worksurface mounted corner screens have 16 7/8" above the worksurface. The curved wood screen is 8 1/2" below the surface and the metal is 6"
- Worksurface mounted corner wood curved screens are finished in a clear coat on maple
- Worksurface mounted corner metal screens can be painted in all standard colours
- All worksurface mounted corner screens are handed left or right. The handedness is determined from the user perspective (i.e. a left handed screen would install on the left hand side of the user)
- Screens are worksurface specific due to corner detail differences between wood and metal
- ONLY metal worksurface mounted corner screens are compatible with freestanding height adjustable worksurfaces
- There will be a 1" wire management gap between the screen and the back side of the worksurface

Notes

In order to get a total cost on products when upcharges are present take the list price of the product number and add the upcharge cost shown to the list price.

**For example:
Product INBWMCSWLH with a Grade D fabric skin would be \$971
++\$0 +\$105**

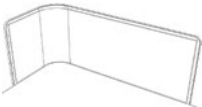
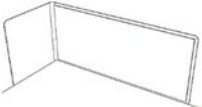
Description	Part number	Height	Width	Depth	Screen list/base	No fabric layer	Fabric skin options						Accent paint
							Grade A/COM	Grade B	Grade C	Grade D	Grade E	Grade F	
 Worksurface Mounted Corner Wood Curved Screen For use with curved perpendicular worksurfaces	INBWMCSvWLH left handed (illustrated)	26 1/2"	38 1/4"	17"	\$971	-\$192	+\$0	+\$67	+\$87	+\$105	+\$118	+\$134	+\$98
	INBWMCSWRH right handed	26 1/2"	38 1/4"	17"	\$971	-\$192	+\$0	+\$67	+\$87	+\$105	+\$118	+\$134	+\$98
 Worksurface Mounted Corner Metal Screen For use with straight perpendicular worksurfaces	INBWMCSMLH left handed (illustrated)	24"	41"	17"	\$575	-\$172	+\$0	+\$67	+\$87	+\$105	+\$118	+\$134	+\$58
	INBWMCSMRH right handed	24"	41"	17"	\$575	-\$172	+\$0	+\$67	+\$87	+\$105	+\$118	+\$134	+\$58

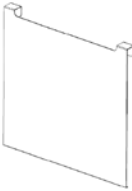
Description	Part number	Height	Width	Depth	List price
 Hand-On Whiteboard Accessory for worksurface Mounted Wood Screens	INBAWHTBRD1816	16"	18"	—	\$60
	INBAWHTBRD1116	16"	9 1/2"	—	\$56

Bench

Accessories

The Arrivals Collection
Upmont Shelves

General information



- For use with Inscape Bench only
- Screens and shelves (both metal and wood) have an OPTIONAL feature for a tackable fabric "skin" on the inside. Base price is without skin
- The fabric skin on the wood screens wraps all the way around the interior of the screen. On metal screens it is only on interior back
- Wood upmount shelf screens are finished in a clear coat on maple
- Wood upmount shelves and screens have a 5.5" curved corner while metal upmount shelves and screens have a 1" corner
- Metal upmount shelf screens can be painted in all standard colours
- Back to back metal upmount shelves are handed left or right. The handedness is determined from the user perspective (i.e. a left handed screen would be open on the left hand side when user is looking at the spine)
- Upmount shelves can be use with either parallel or perpendicular worksurface applications; however, they can NOT be used on fully freestanding straight applications. Even one where docking brackets are used
- 72" sizes come with a 72" top cap

Notes

In order to get a total cost on products when upcharges are present take the list price of the product number and add the upcharge cost shown to the list price.

For example:

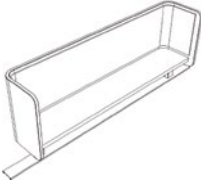
Product INBUPSHELFW-36 with a Grade D fabric skin and a Grade 1 laminate shelf would be \$1221 +\$0 +\$53 +\$123

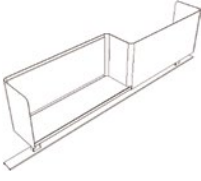
Description	Part number	Height	Width	Depth	List/base	Fabric skin options							Accent paint																									
						No fabric layer	Grade A/COM	Grade B	Grade C	Grade D	Grade E	Grade F																										
 <p>Single Wood Upmount Shelf</p>	INBUPSHELFW-36 For use with a 36" w spine frame	15 1/2"	26"	10 5/8"	\$1221	-\$155	+\$0	+\$35	+\$44	+\$53	+\$59	+\$69	+\$123																									
	INBUPSHELFW-60 For use with a 60" w spine frame	15 1/2"	50"	10 5/8"	\$1288	-\$171	+\$0	+\$35	+\$44	+\$53	+\$59	+\$69	+\$129																									
			<table border="1"> <thead> <tr> <th colspan="5">Shelf finish options</th> </tr> <tr> <th>Product number</th> <th>Nuform solid/laminate</th> <th>Nuform woodgrain</th> <th>Grade 1 laminate</th> <th>Grade 2 lamainte</th> </tr> </thead> <tbody> <tr> <td>INBUPSHELFW-36</td> <td>+\$0</td> <td>+\$19</td> <td>+\$123</td> <td>+\$246</td> </tr> <tr> <td>INBUPSHELFW-60</td> <td>+\$0</td> <td>+\$24</td> <td>+\$139</td> <td>+\$277</td> </tr> </tbody> </table>												Shelf finish options					Product number	Nuform solid/laminate	Nuform woodgrain	Grade 1 laminate	Grade 2 lamainte	INBUPSHELFW-36	+\$0	+\$19	+\$123	+\$246	INBUPSHELFW-60	+\$0	+\$24	+\$139	+\$277				
Shelf finish options																																						
Product number	Nuform solid/laminate	Nuform woodgrain	Grade 1 laminate	Grade 2 lamainte																																		
INBUPSHELFW-36	+\$0	+\$19	+\$123	+\$246																																		
INBUPSHELFW-60	+\$0	+\$24	+\$139	+\$277																																		
 <p>Single Metal Upmount Shelf</p>	INBUPSHELFM-36 For use with a 36" w spine frame	14.062"	26"	9 1/2"	\$820	-\$134	+\$0	+\$35	+\$44	+\$53	+\$59	+\$69	+\$83																									
	INBUPSHELFM-60 For use with a 60" w spine frame	14.062"	50"	9 1/2"	\$971	-\$152	+\$0	+\$35	+\$44	+\$53	+\$59	+\$69	+\$98																									
	INBUPSHELFM-72 For use with a 72" w (2x 36") spine frame	14.062"	62"	9 1/2"	\$1132	-\$178	+\$0	+\$50	+\$64	+\$79	+\$88	+\$100	+\$114																									
		<table border="1"> <thead> <tr> <th colspan="5">Shelf finish options</th> </tr> <tr> <th>Product number</th> <th>Nuform solid/laminate</th> <th>Nuform woodgrain</th> <th>Grade 1 laminate</th> <th>Grade 2 lamainte</th> </tr> </thead> <tbody> <tr> <td>INBUPSHELFM-36</td> <td>+\$0</td> <td>+\$19</td> <td>+\$123</td> <td>+\$246</td> </tr> <tr> <td>INBUPSHELFM-60</td> <td>+\$0</td> <td>+\$24</td> <td>+\$139</td> <td>+\$277</td> </tr> <tr> <td>INBUPSHELFM-72</td> <td>+\$0</td> <td>+\$37</td> <td>+\$227</td> <td>+\$452</td> </tr> </tbody> </table>												Shelf finish options					Product number	Nuform solid/laminate	Nuform woodgrain	Grade 1 laminate	Grade 2 lamainte	INBUPSHELFM-36	+\$0	+\$19	+\$123	+\$246	INBUPSHELFM-60	+\$0	+\$24	+\$139	+\$277	INBUPSHELFM-72	+\$0	+\$37	+\$227	+\$452
Shelf finish options																																						
Product number	Nuform solid/laminate	Nuform woodgrain	Grade 1 laminate	Grade 2 lamainte																																		
INBUPSHELFM-36	+\$0	+\$19	+\$123	+\$246																																		
INBUPSHELFM-60	+\$0	+\$24	+\$139	+\$277																																		
INBUPSHELFM-72	+\$0	+\$37	+\$227	+\$452																																		
 <p>Back to Back Metal Upmount Shelf</p>	INBUPSHELFM72LH For use with a 72" w (2x 36") spine frame left handed (illustrated)	14 1/8"	62"	9 1/2"	\$1117	-\$141	+\$0	+\$26	+\$33	+\$40	+\$45	+\$51	+\$112																									
	INBUPSHELFM72RH For use with a 72" w (2x 36") spine frame right handed	14 1/8"	62"	9 1/2"	\$1117	-\$141	+\$0	+\$26	+\$33	+\$40	+\$45	+\$51	+\$112																									
			<table border="1"> <thead> <tr> <th colspan="5">Shelf finish options</th> </tr> <tr> <th>Product number</th> <th>Nuform solid/laminate</th> <th>Nuform woodgrain</th> <th>Grade 1 laminate</th> <th>Grade 2 lamainte</th> </tr> </thead> <tbody> <tr> <td>INBUPSHELFM72LH</td> <td>+\$0</td> <td>+\$37</td> <td>+\$246</td> <td>+\$492</td> </tr> <tr> <td>INBUPSHELFM72RH</td> <td>+\$0</td> <td>+\$37</td> <td>+\$246</td> <td>+\$492</td> </tr> </tbody> </table>												Shelf finish options					Product number	Nuform solid/laminate	Nuform woodgrain	Grade 1 laminate	Grade 2 lamainte	INBUPSHELFM72LH	+\$0	+\$37	+\$246	+\$492	INBUPSHELFM72RH	+\$0	+\$37	+\$246	+\$492				
Shelf finish options																																						
Product number	Nuform solid/laminate	Nuform woodgrain	Grade 1 laminate	Grade 2 lamainte																																		
INBUPSHELFM72LH	+\$0	+\$37	+\$246	+\$492																																		
INBUPSHELFM72RH	+\$0	+\$37	+\$246	+\$492																																		

General information
 • For replacement parts only

Notes

In order to get a total cost on products when upcharges are present take the list price of the product number and add the upcharge cost shown to the list price.

For example:

Product INBWMCSWSKIN in Grade D would be \$192 +\$105

Description	Part number	Height	Width	Grade A/COM/ base	Grade B	Grade C	Grade D	Grade E	Grade F
 Replacement Fabric Skin for Corner Wood Curved Screen left and right hand compatible	INBWMCSWSKIN	16 1/8"	51 5/8"	\$192	+\$67	+\$87	+\$105	+\$118	+\$134

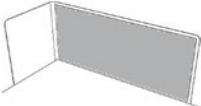
 Replacement Fabric Skin for Corner Metal Screen left and right hand compatible	INBWMCSMSKIN	16 1/8"	39 1/8"	\$172	+\$67	+\$87	+\$105	+\$118	+\$134
---	---------------------	---------	---------	-------	-------	-------	--------	--------	--------

Accessories

The Arrivals Collection
Replacement Fabric Skins

General information

- For replacement parts only

Notes

In order to get a total cost on products when upcharges are present take the list price of the product number and add the upcharge cost shown to the list price.

For example:

Product INBSHELFWSKIN36 in Grade D would be \$155 +\$53

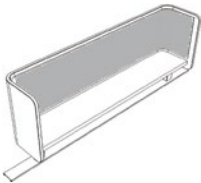
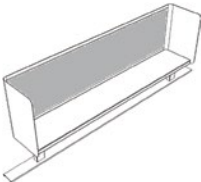
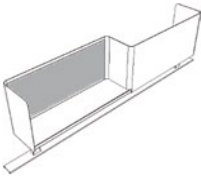
Description	Part number	Height	Width	Grade A/COM/ base	Grade B	Grade C	Grade D	Grade E	Grade F
	INBSHELFWSKIN36 When shelf is used on a 36" w spine frame	11 1/2"	39 7/8"	\$155	+\$35	+\$44	+\$53	+\$59	+\$69
	INBSHELFWSKIN60 When shelf is used on a 60" w spine frame	11 1/2"	63 7/8"	\$171	+\$35	+\$44	+\$53	+\$59	+\$69
Replacement Fabric Skin for Single Wood Upmount Shelf									
	INBSHELFMSKIN36 When shelf is used on a 36" w spine frame	11 5/8"	24 1/2"	\$134	+\$35	+\$44	+\$53	+\$59	+\$69
	INBSHELFMSKIN60 When shelf is used on a 60" w spine frame	11 5/8"	48 1/2"	\$152	+\$35	+\$44	+\$53	+\$59	+\$69
Replacement Fabric Skin for Single Metal Upmount Shelf									
	INBSHELFMSKIN72 When shelf is used on a 72" w (2x 36") spine frame	11 5/8"	60 1/2"	\$178	+\$50	+\$64	+\$79	+\$88	+\$100
	INBSHELFMSK72 When shelf is used on a 72" w (2x 36") spine frame	11 5/8"	29 1/8"	\$141	+\$26	+\$33	+\$40	+\$45	+\$51
Replacement Fabric Skin for Back to Back Metal Upmount Shelf left and right hand compatible single side replacement part									

General information

- Transaction Top is available in 1" thick Nuform or Laminate finishes
- Flat trim profile only
- 1" thick worksurface
- Worksurface is inset 5" on each side from the ends of the top cap
- 72" (36" top caps) wide kits consist of two top caps and four stanchions
- On-module installation only
- Stanchions have a rectangular profile

Notes

In order to get a total cost on products when an upcharge or downcharge is present you take the list price of the product number and add the upcharge or deduct the downcharge cost shown to the list price.

For example:

Product INBACTRTOP-36 in Nuform Woodgrain would be \$392 +\$19

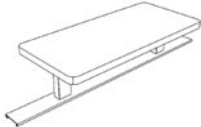
Description	Part number	Height	Width	Depth	Nuform solid/laminate	Nuform woodgrain	Grade 1 laminate	Grade 2 laminate	Accent paint	
	Arrivals Collection	INBACTRTOP-36	6 5/16"	36"	12"	\$392	+\$19	+\$123	+\$246	+\$40
	Transaction Top	INBACTRTOP-42	6 5/16"	42"	12"	\$402	+\$21	+\$120	+\$239	+\$41
		INBACTRTOP-48	6 5/16"	48"	12"	\$423	+\$23	+\$129	+\$258	+\$43
		INBACTRTOP-54	6 5/16"	54"	12"	\$445	+\$24	+\$135	+\$270	+\$45
		INBACTRTOP-60	6 5/16"	60"	12"	\$450	+\$24	+\$139	+\$277	+\$46
		INBACTRTOP-72	6 5/16"	72"	12"	\$739	+\$37	+\$227	+\$452	+\$75

Left blank intentionally.

Tables
US Price List
September 2018

Left blank intentionally.

tables

Arrivals Tables Collection

Tables

Arrivals Tables Collection

Standing Height Tables

General information



- Codes come complete with surfaces, legs and optional power
- If power is optioned on tables with the flip up modules, the worksurfaces come with cut out(s)
- Worksurfaces are 1 ¼" thick only and available in laminate, grade 1 laminate (plywood edge) and Nuform surface finishes
- When manually specifying worksurface of laminate or veneer add suffix "-S" to the code
- Laminate is available in straight edge only
- Nuform is available in straight or tapered edge
- Legs are angled and conical shaped with black leveling glides
- Legs are available in Clear Oak (default), Black Oak and Clear Maple finishes
- Standing Height Tables include a foot rail that is available in all standard paint colors. Accent paint colours have an upcharge.
- The Flip-up power module is available in matte black, matte white and aluminium finishes
- The Mini Tap power module has a 72" long cord and is available in black only

Note

In order to get a total cost on products when an upcharge or downcharge is present you take the list price of the product number and add the upcharge or deduct the downcharge cost shown to the list price.





For example:

Product TCRSTA3060 in Nuform Woodgrain with a Tapered Edge and 2 power modules would be \$2183 +\$60 +\$31 +\$631

Description	Part number	Height	Width	Depth	Thickness	Straight edge nuform solid/laminate (base)	Nuform woodgrain/pattern	Nuform tapered edge	Grade 1 laminate Straight Edge only	Power options			Accent paint
										None	1 module	2 modules	
 Curved Rectangular Standing Height Table available with Mini Tap power option	TCRSTA3060	39"	60"	30"	1 ¼"	\$2183	+\$60	+\$31	+\$186	+\$0	+\$322	+\$631	+\$219
	TCRSTA3072	39"	72"	30"	1 ¼"	\$2236	+\$72	+\$51	+\$221	+\$0	+\$322	+\$631	+\$225
	TCRSTA3660	39"	60"	36"	1 ¼"	\$2351	+\$71	+\$101	+\$233	+\$0	+\$322	+\$631	+\$236
	TCRSTA3672	39"	72"	36"	1 ¼"	\$2464	+\$81	+\$111	+\$249	+\$0	+\$322	+\$631	+\$247
 Rectangular Standing Height Table available with Mini Tap power option	TRECSTA3060	39"	60"	30"	1 ¼"	\$2183	+\$60	+\$31	+\$186	+\$0	+\$322	+\$631	+\$219
	TRECSTA3072	39"	72"	30"	1 ¼"	\$2236	+\$72	+\$51	+\$221	+\$0	+\$322	+\$631	+\$225
	TRECSTA3660	39"	60"	36"	1 ¼"	\$2351	+\$71	+\$101	+\$233	+\$0	+\$322	+\$631	+\$236
	TRECSTA3672	39"	72"	36"	1 ¼"	\$2470	+\$81	+\$111	+\$249	+\$0	+\$322	+\$631	+\$248
 Round Standing Height Table available with Mini Tap power option	TRNDSTA36	39"	36"	36"	1 ¼"	\$2186	+\$39	+\$21	+\$120	+\$0	+\$322	+\$631	+\$220
	TRNDSTA42	39"	42"	42"	1 ¼"	\$2266	+\$55	+\$29	+\$170	+\$0	+\$322	+\$631	+\$228
	TRNDSTA48	39"	48"	48"	1 ¼"	\$2350	+\$72	+\$36	+\$221	+\$0	+\$322	+\$631	+\$236

General information

- Codes come complete with surfaces, legs and optional power
- If power is optioned on tables with the flip up modules, the worksurfaces come with cut out(s)
- Worksurfaces are 1 ¼" thick only and available in laminate, grade 1 laminate (plywood edge) and Nuform surface finishes
- Laminate is available in straight edge only
- When manually specifying worksurface of laminate or veneer add suffix “-S” to the code
- Nuform is available in straight or tapered edge
- Legs are angled and conical shaped with black leveling glides
- Legs are available in Clear Oak (default), Black Oak and Clear Maple finishes The Flip-up power module is available in matte black, matte white and aluminium finishes
- The Mini Tap power module has a 72" long cord and is available in black only
- 60"w and 72"w meeting tables can accomodate 1 flip-up power module only
- 84"w and 96"w meeting tables can accomodate 2 flip-up power modules only

Description	Part number	Height	Width	Depth	Thickness	Straight edge nuform solid/laminate (base)	Nuform woodgrain/pattern	Nuform tapered Edge	Grade 1 laminate Straight Edge only	Power options		
										None	1 module	2 modules
 <p>Curved Rectangular Meeting Table available with Flip-up power option</p>	TCRECMTG3660	28.5"	60"	36"	1 ¼"	\$1795	+\$71	+\$101	+\$218	+\$0	+\$436	—
	TCRECMTG3672	28.5"	72"	36"	1 ¼"	\$1845	+\$81	+\$111	+\$249	+\$0	+\$436	—
	TCRECMTG3684	28.5"	84"	36"	1 ¼"	\$2036	+\$99	+\$135	+\$305	+\$0	—	+\$851
	TCRECMTG3696	28.5"	96"	36"	1 ¼"	\$2122	+\$120	+\$165	+\$371	+\$0	—	+\$851
	TCRECMTG4260	28.5"	60"	42"	1 ¼"	\$1826	+\$80	+\$117	+\$245	+\$0	+\$436	—
	TCRECMTG4272	28.5"	72"	42"	1 ¼"	\$1881	+\$94	+\$140	+\$290	+\$0	+\$436	—
	TCRECMTG4284	28.5"	84"	42"	1 ¼"	\$2076	+\$114	+\$168	+\$352	+\$0	—	+\$851
	TCRECMTG4296	28.5"	96"	42"	1 ¼"	\$2167	+\$139	+\$203	+\$428	+\$0	—	+\$851
	TCRECMTG4860	28.5"	60"	48"	1 ¼"	\$1858	+\$91	+\$134	+\$280	+\$0	+\$436	—
	TCRECMTG4872	28.5"	72"	48"	1 ¼"	\$1917	+\$107	+\$161	+\$330	+\$0	+\$436	—
	TCRECMTG4884	28.5"	84"	48"	1 ¼"	\$2117	+\$131	+\$193	+\$405	+\$0	—	+\$851
TCRECMTG4896	28.5"	96"	48"	1 ¼"	\$2212	+\$161	+\$234	+\$497	+\$0	—	+\$851	
 <p>Curved Rectangular Meeting Table available with Mini Tap power option</p>	TCRECMTG3636	28.5"	36"	36"	1 ¼"	\$1546	+\$47	+\$70	+\$146	+\$0	+\$322	+\$631
	TCRECMTG4242	28.5"	42"	42"	1 ¼"	\$1594	+\$57	+\$83	+\$176	+\$0	+\$322	+\$631
	TCRECMTG4848	28.5"	48"	48"	1 ¼"	\$1647	+\$75	+\$108	+\$230	+\$0	+\$322	+\$631
 <p>Rectangular Meeting Table available with Flip-up power option</p>	TRECMTG3660	28.5"	60"	36"	1 ¼"	\$1795	+\$71	+\$101	+\$218	+\$0	+\$436	—
	TRECMTG3672	28.5"	72"	36"	1 ¼"	\$1845	+\$81	+\$111	+\$249	+\$0	+\$436	—
	TRECMTG3684	28.5"	84"	36"	1 ¼"	\$2036	+\$99	+\$135	+\$305	+\$0	—	+\$851
	TRECMTG3696	28.5"	96"	36"	1 ¼"	\$2122	+\$120	+\$165	+\$371	+\$0	—	+\$851
	TRECMTG4260	28.5"	60"	42"	1 ¼"	\$1826	+\$80	+\$117	+\$245	+\$0	+\$436	—
	TRECMTG4272	28.5"	72"	42"	1 ¼"	\$1881	+\$94	+\$140	+\$290	+\$0	+\$436	—
	TRECMTG4284	28.5"	84"	42"	1 ¼"	\$2076	+\$114	+\$168	+\$352	+\$0	—	+\$851
	TRECMTG4296	28.5"	96"	42"	1 ¼"	\$2167	+\$139	+\$203	+\$428	+\$0	—	+\$851
	TRECMTG4848	28.5"	48"	48"	1 ¼"	\$1647	+\$75	+\$108	+\$230	+\$0	+\$322	+\$631
	TRECMTG4872	28.5"	72"	48"	1 ¼"	\$1917	+\$107	+\$161	+\$330	+\$0	+\$436	—
	TRECMTG4884	28.5"	84"	48"	1 ¼"	\$2117	+\$131	+\$193	+\$405	+\$0	—	+\$851
TRECMTG4896	28.5"	96"	48"	1 ¼"	\$2212	+\$161	+\$234	+\$497	+\$0	—	+\$851	
 <p>Rectangular Meeting Table available with Mini Tap power option</p>	TRECMTG3636	28.5"	36"	36"	1 ¼"	\$1546	+\$47	+\$70	+\$146	+\$0	+\$322	+\$631
	TRECMTG4242	28.5"	42"	42"	1 ¼"	\$1594	+\$57	+\$83	+\$176	+\$0	+\$322	+\$631
	TRECMTG4848	28.5"	48"	48"	1 ¼"	\$1647	+\$75	+\$108	+\$230	+\$0	+\$322	+\$631
 <p>Round Meeting Table available with Mini Tap power option</p>	TRNDMTG36	28.5"	36"	36"	1 ¼"	\$1525	+\$39	+\$22	+\$120	+\$0	+\$322	+\$631
	TRNDMTG42	28.5"	42"	42"	1 ¼"	\$1588	+\$55	+\$29	+\$170	+\$0	+\$322	+\$631
	TRNDMTG48	28.5"	48"	48"	1 ¼"	\$1659	+\$72	+\$36	+\$221	+\$0	+\$322	+\$631

Tables

Arrivals Tables Collection

Coffee Tables

General information



- Codes come complete with surfaces, legs and optional power
- If power is optioned on tables with the flip up modules, the worksurfaces come with cut out(s)
- Worksurfaces are 1 ¼" thick only and available in laminate, grade 1 laminate (plywood edge) and Nuform surface finishes
- When manually specifying worksurface of laminate or veneer add suffix "-S" to the code
- Laminate is available in straight edge only
- Nuform is available in straight or tapered edge
- Legs are angled and conical shaped with black leveling glides
- Legs are available in Clear Oak (default), Black Oak and Clear Maple finishes
- The Mini Tap power module has a 72" long cord and is available in black only

Note

In order to get a total cost on products when an upcharge or downcharge is present you take the list price of the product number and add the upcharge or deduct the downcharge cost shown to the list price.

For example:

Product TCRCOF30 in Nuform Woodgrain with a Tapered Edge and 2 power modules would be \$1059 +\$37 +\$21 +\$631

Description	Part number	Height	Width	Depth	Thickness	Straight edge nuform solid/laminate (base)	Nuform woodgrain/pattern	Nuform tapered Edge	Grade 1 laminate Straight Edge only	Power options		
										None	1 module	2 modules
 Curved Rectangular Coffee Table available with Mini Tap power option	TCRCOF30	17"	30"	30"	1 ¼"	\$1059	+\$37	+\$21	+\$114	+\$0	+\$322	+\$631
	TCRCOF36	17"	36"	36"	1 ¼"	\$1137	+\$47	+\$70	+\$146	+\$0	+\$322	+\$631
	TCRCOF42	17"	42"	42"	1 ¼"	\$1185	+\$57	+\$83	+\$176	+\$0	+\$322	+\$631
 Rectangular Coffee Table available with Mini Tap power option	TSQUCOF30	17"	30"	30"	1 ¼"	\$1059	+\$37	+\$21	+\$114	+\$0	+\$322	+\$631
	TSQUCOF36	17"	36"	36"	1 ¼"	\$1137	+\$47	+\$70	+\$146	+\$0	+\$322	+\$631
	TSQUCOF42	17"	42"	42"	1 ¼"	\$1185	+\$57	+\$83	+\$176	+\$0	+\$322	+\$631
 Round Coffee Table available with Mini Tap power option	TRNDCOF30	17"	30"	30"	1 ¼"	\$1059	+\$35	+\$21	+\$108	+\$0	+\$322	+\$631
	TRNDCOF36	17"	36"	36"	1 ¼"	\$1116	+\$39	+\$22	+\$120	+\$0	+\$322	+\$631
	TRNDCOF42	17"	42"	42"	1 ¼"	\$1180	+\$55	+\$29	+\$170	+\$0	+\$322	+\$631

tables

Worksurfaces

Left blank intentionally.

General information

- 60"-72" W rectangular tops require a stretcher bar
- 78" W and over rectangular tops require a center leg
- Tables are true to size
- When manually specifying worksurface of Plastic Laminate or Veneer add suffix "-S" to the code
- The tapered edge option on the 30" and 36" deep worksurfaces will only be on the front edge if specified
- The tapered edge option on the 42" and 48" deep worksurfaces will be on the all four sides if specified

Note





In order to get a total cost on products when an upcharge or downcharge is present you take the list price of the product number and add the upcharge or deduct the downcharge cost shown to the list price.

For example:

Product TW3030 in Nuform Woodgrain with a Tapered Edge would be \$341 +\$37 +\$21

Product TW3030 in Nuform Woodgrain with a 1" Straight Edge would be \$341 +\$37 -\$36

Product TW3030 in Veneer would be \$341 +\$635

Description	Part number	Width	Depth	.125" Straight edge nuform solid/laminate (base)	Nuform woodgrain/pattern	Nuform tapered edge	1" Straight edge nuform solid	Grade 1 laminate Straight Edge only	Veneer 1.25" Straight Edge only
 30" D Rectangular Top	TW3030	30"	30"	\$341	+\$37	+\$21	-\$36	+\$110	+\$635
	TW3036	36"	30"	\$389	+\$40	+\$22	-\$39	+\$125	+\$662
	TW3042	42"	30"	\$411	+\$43	+\$22	-\$42	+\$132	+\$703
	TW3048	48"	30"	\$468	+\$49	+\$26	-\$47	+\$150	+\$709
	TW3054	54"	30"	\$526	+\$54	+\$27	-\$52	+\$169	+\$717
	TW3060	60"	30"	\$587	+\$59	+\$29	-\$59	+\$188	+\$722
	TW3066	66"	30"	\$627	+\$63	+\$32	-\$63	+\$201	+\$755
	TW3072	72"	30"	\$703	+\$71	+\$34	-\$71	+\$225	+\$737
	TW3078	78"	30"	\$779	+\$78	+\$39	-\$77	+\$250	+\$738
	TW3084	84"	30"	\$854	+\$88	+\$44	-\$87	+\$274	+\$690
	TW3090	90"	30"	\$930	+\$94	+\$48	-\$94	+\$298	+\$670
TW3096	96"	30"	\$1007	+\$102	+\$51	-\$101	+\$323	+\$655	
 36" D Rectangular Top	TW3636	36"	36"	\$452	+\$47	+\$70	-\$47	+\$145	+\$672
	TW3642	42"	36"	\$477	+\$48	+\$73	-\$49	+\$153	+\$816
	TW3648	48"	36"	\$541	+\$57	+\$84	-\$59	+\$174	+\$843
	TW3654	54"	36"	\$609	+\$63	+\$92	-\$59	+\$195	+\$853
	TW3660	60"	36"	\$682	+\$71	+\$101	-\$71	+\$219	+\$905
	TW3666	66"	36"	\$723	+\$74	+\$106	-\$74	+\$232	+\$944
	TW3672	72"	36"	\$814	+\$81	+\$111	-\$81	+\$261	+\$931
	TW3678	78"	36"	\$903	+\$89	+\$123	-\$87	+\$289	+\$913
	TW3684	84"	36"	\$992	+\$99	+\$135	-\$96	+\$318	+\$889
	TW3690	90"	36"	\$1091	+\$110	+\$150	-\$104	+\$350	+\$857
	TW3696	96"	36"	\$1198	+\$120	+\$165	-\$114	+\$384	+\$818
 42" D Rectangular Top	TW4242	42"	42"	\$556	+\$57	+\$83	—	+\$178	+\$1003
	TW4260	60"	42"	\$792	+\$80	+\$117	—	+\$254	+\$1119
	TW4272	72"	42"	\$943	+\$94	+\$140	—	+\$302	+\$1158
	TW4284	84"	42"	\$1138	+\$114	+\$168	—	+\$365	+\$1114
	TW4296	96"	42"	\$1375	+\$139	+\$203	—	+\$440	+\$1041
 48" D Rectangular Top	TW4848	48"	48"	\$724	+\$75	+\$108	—	+\$232	+\$1276
	TW4860	60"	48"	\$909	+\$91	+\$134	—	+\$291	+\$1380
	TW4872	72"	48"	\$1084	+\$107	+\$161	—	+\$347	+\$1434
	TW4884	84"	48"	\$1309	+\$131	+\$193	—	+\$419	+\$1392
	TW4896	96"	48"	\$1579	+\$161	+\$234	—	+\$506	+\$1316

Tables

Worksurfaces

Racetrack and Boat Tops

General information

- Racetrack Tops for use with 2 cylindrical table bases
- Bases are not included. See Legs and Bases section
- Tables are true to size
- When manually specifying worksurface of Plastic Laminate or Veneer add suffix "-S" to the code
- Stretcher bars are required for unsupported worksurfaces of 54" W or wider





Note

In order to get a total cost on products when an upcharge or downcharge is present you take the list price of the product number and add the upcharge or deduct the downcharge cost shown to the list price.

For example:

Product TWRT3672 in Nuform Woodgrain with a Tapered Edge would be \$862 +\$85 +\$116

Product TWRT3672 in Veneer would be \$862 +\$977

Description	Part number	Width	Depth	.125" Straight edge nuform solid/laminate (base)	Nuform woodgrain/pattern	Nuform tapered edge	1" Straight edge nuform solid	Grade 1 laminate Straight Edge only	Veneer 1.25" Straight Edge only
 Racetrack Top For use with 2 cylindrical table bases	TWRT3672	72"	36"	\$862	+\$85	+\$116	—	+\$276	+\$977
	TWRT4284	84"	42"	\$1197	+\$119	+\$177	—	+\$384	+\$1170
	TWRT4896	96"	48"	\$1657	+\$168	+\$245	—	+\$531	+\$1381
 36" D Boat Top	TWBT3672	72"	36"	\$862	+\$85	+\$116	—	+\$276	+\$977
	TWBT4284	84"	42"	\$1197	+\$119	+\$177	—	+\$384	+\$1170
 42" D Boat Top	TWBT4296	96"	42"	\$1444	+\$145	+\$214	—	+\$463	+\$1094
	TWBT4884	84"	48"	\$1374	+\$138	+\$245	—	+\$440	+\$1462
 48" D Boat Top	TWBT4896	96"	48"	\$1657	+\$1793	+\$1870	—	+\$531	+\$3007

General information

- Tables are true to size
- When manually specifying worksurface of Plastic Laminate or Veneer add suffix "-S" to the code

Note



In order to get a total cost on products when an upcharge or downcharge is present you take the list price of the product number and add the upcharge or deduct the downcharge cost shown to the list price.

For example:

Product TWRND30 in Nuform Woodgrain with a Tapered Edge would be \$375 +\$35 +\$21

Product TWRND30 in Nuform Woodgrain with a 1" Straight Edge would be \$375 +\$35 -\$21

Product TWRND30 in Veneer would be \$375 +\$298

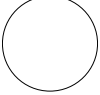
Description	Part number	Width	Depth	1.25" Straight edge nuform solid/ laminate (base)	Nuform woodgrain/ pattern	Nuform tapered edge	1" Straight edge nuform solid	Grade 1 laminate Straight Edge onl	Veneer 1.25" Straight Edge only
 30" D Round Top	TWRND30	30"	30"	\$375	+\$35	+\$21	-\$21	+\$120	+\$298
 36" D Round Top	TWRND36	36"	36"	\$412	+\$39	+\$22	-\$23	+\$132	+\$476
 42" D Round Top	TWRND42	42"	42"	\$573	+\$55	+\$29	-\$29	+\$184	+\$564
 48" D Round Top	TWRND48	48"	48"	\$722	+\$72	+\$36	-\$36	+\$232	+\$698

Tables

Worksurfaces

Semi-circle Tops

General information

- Requires 2 legs and 2 flush brackets
- Legs and brackets are not included. See Legs and Bases section
- Tables are true to size
- Grain direction runs from straight edge towards arc on the 42"W and 48"W surfaces
- Grain direction runs from side to side on the 60"W and 72"W surfaces
- When manually specifying worksurface of Plastic Laminate or Veneer add suffix "-S" to the code
- Stretcher bars are required for unsupported worksurfaces of 54" W or wider

Note

In order to get a total cost on products when an upcharge or downcharge is present you take the list price of the product number and add the upcharge or deduct the downcharge cost shown to the list price.

For example:

Product TWSC4221 in Nuform Woodgrain with a Tapered Edge would be \$413 +\$46 +\$25

Product TWSC4221 in Nuform Woodgrain with a 1" Straight Edge would be \$413 +\$46 -\$44

Product TWSC4221 in Veneer would be \$413 +\$324

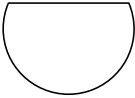
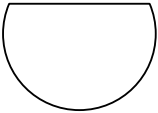
Description	Part number	Width	Depth	1.25" Straight edge nuform solid/laminate (base)	Nuform woodgrain/pattern	Nuform tapered edge	1" Straight edge nuform solid	Grade 1 laminate Straight Edge onl	Veneer 1.25" Straight Edge only
 42" W Semi-circle Top	TWSC4221	42"	21"	\$413	+\$46	+\$25	-\$44	+\$133	+\$324
 48" W Semi-circle Top	TWSC4824	48"	24"	\$515	+\$54	+\$27	-\$54	+\$165	+\$403
 60" W Semi-circle Top	TWSC6030	60"	30"	\$717	+\$73	+\$34	-\$72	+\$230	+\$563
 72" W Semi-circle Top	TWSC7236	72"	36"	\$918	+\$90	+\$40	-\$88	+\$294	+\$722

General information

- Requires one post leg and 2 flush mount brackets
- Legs and brackets are not included. See Legs and Bases section
- Tables are true to size
- When manually specifying worksurface of Plastic Laminate or Veneer add suffix "-S" to the code

Note



In order to get a total cost on products when an upcharge or downcharge is present you take the list price of the product number and add the upcharge or deduct the downcharge cost shown to the list price.

For example:

Product TWQC30 in Nuform Woodgrain with a Tapered Edge would be \$359 +\$36 +\$18

Product TWQC30 in Nuform Woodgrain with a 1" Straight Edge would be \$359 +\$36 -\$35

Product TWQC30 in Veneer would be \$359 +\$282

Description	Part number	Width	Depth	1.25" Straight edge nuform solid/ laminate (base)	Nuform woodgrain/ pattern	Nuform tapered edge	1" Straight edge nuform solid	Grade 1 laminate Straight Edge only	Veneer 1.25" Straight Edge only
 30" D Quarter-circle Top	TWQC30	30"	30"	\$359	+\$36	+\$18	-\$35	+\$115	+\$282
 36" D Quarter-circle Top	TWQC36	36"	36"	\$460	+\$46	+\$22	-\$44	+\$148	+\$361

Tables

Worksurfaces

Trapezoid Tops

General information

- Tables are true to size
- When manually specifying worksurface of Plastic Laminate or Veneer add suffix "-S" to the code
- Stretcher bars are required for unsupported worksurfaces of 54" W or wider



Note

In order to get a total cost on products when an upcharge or downcharge is present you take the list price of the product number and add the upcharge or deduct the downcharge cost shown to the list price.

For example:

Product TWTRAP3060 in Nuform Woodgrain with a 1" Straight Edge would be \$643 +\$64 -\$63

Product TWTRAP3060 in Veneer would be \$643 +\$781

Description	Part number	Width	Depth	1.25" Straight edge nuform solid/laminate (base)	Nuform woodgrain/pattern	Nuform tapered edge	1" Straight edge nuform solid	Grade 1 laminate Straight Edge only	Veneer 1.25" Straight Edge only
 Trapezoid Top 30"x30"x60"	TWTRAP3060	60"	—	\$643	+\$64	—	-\$63	+\$206	+\$781
 Trapezoid Top 24"x24"x48"	TWTRAP2448	48"	—	\$484	+\$48	—	-\$48	+\$155	+\$586

General information





- Tables are true to size
- Not available in tapered edge
- Stretcher bars are required for unsupported worksurfaces of 54" W or wider
- When manually specifying worksurface of Plastic Laminate or Veneer add suffix "-S" to the code
- Pebble Top for use with 1 cylindrical table base only
- Rhombus Top for use with 2 cylindrical table bases only

Note

In order to get a total cost on products when an upcharge or downcharge is present you take the list price of the product number and add the upcharge or deduct the downcharge cost shown to the list price.

For example:

Product TWHEXL3072 in Nuform Woodgrain with a 1" Straight Edge would be \$768 +\$77 -\$76

Description	Part number	Width	Depth	1.25" Straight edge nuform solid/laminate (base)	Nuform woodgrain/pattern	Nuform tapered edge	1" Straight edge nuform solid	Veneer 1.25" Straight Edge only
 Hex Top	TWHEXL3072 left-handed	72"	30"	\$768	+\$77	—	-\$76	—
 Hex Top	TWHEXR3072 right-handed	72"	30"	\$768	+\$77	—	-\$76	—
 Pebble Top	TWPEB3648	48"	36"	\$759	+\$75	—	-\$38	—
 Rhombus Top	TWROM4890	90"	48"	\$1657	+\$168	—	-\$159	—

Tables

Worksurfaces

Rectangular Tops with Power Module

General information





- 60" & 72" W rectangular tops require a stretcher bar
- 78" W and over rectangular tops require a center leg
- 30" & 36" deep surfaces include power modules positioned 2" in from the back edge. 60" and 72" wide have one module and 84" & 96" have two modules
- 42" & 48" deep surfaces include power modules centered front to back. 60" & 72" wide have one module and 84" and 96" have two modules
- Stretcher bars are required for unsupported worksurfaces of 54" W or wider
- Rectangular Tops with Flip Up Power Module are not available in Nuform

Notes

In order to get a total cost on products when an upcharge or downcharge is present you take the list price of the product number and add the upcharge or deduct the downcharge cost shown to the list price.

For example:

Product TWP3060-S in Veneer would be \$1380 +\$722

Description	Part number	Width	Depth	.125" Straight edge nuform solid/laminate (base)	Nuform woodgrain/pattern	Nuform tapered edge	1" Straight edge nuform solid	Grade 1 laminate Straight Edge only	Veneer 1.25" Straight Edge only
 30" D Rectangular Top with power module	TWP3060-S	60"	30"	\$1380	—	—	—	+\$442	+\$722
	TWP3072-S	72"	30"	\$1495	—	—	—	+\$479	+\$737
	TWP3084-S	84"	30"	\$1647	—	—	—	+\$528	+\$690
	TWP3096-S	96"	30"	\$1800	—	—	—	+\$576	+\$655
 36" D Rectangular Top with power module	TWP3660-S	60"	36"	\$1474	—	—	—	+\$472	+\$905
	TWP3672-S	72"	36"	\$1605	—	—	—	+\$514	+\$931
	TWP3684-S	84"	36"	\$1777	—	—	—	+\$569	+\$889
	TWP3696-S	96"	36"	\$1982	—	—	—	+\$635	+\$818
 42" D Rectangular Top with power module	TWP4260-S	60"	42"	\$1576	—	—	—	+\$505	+\$1119
	TWP4272-S	72"	42"	\$1728	—	—	—	+\$553	+\$1158
	TWP4284-S	84"	42"	\$1923	—	—	—	+\$616	+\$1114
	TWP4296-S	96"	42"	\$2159	—	—	—	+\$691	+\$1041
 48" D Rectangular Top with power module	TWP4860-S	60"	48"	\$1694	—	—	—	+\$543	+\$1380
	TWP4872-S	72"	48"	\$1868	—	—	—	+\$598	+\$1434
	TWP4884-S	84"	48"	\$2092	—	—	—	+\$670	+\$1392
	TWP4896-S	96"	48"	\$2363	—	—	—	+\$757	+\$1316

Worksurfaces

Bullet, Bean, Oval and Curved Rectangular Tops

General information

- Stretcher bars are required for unsupported worksurfaces of 54" W or wider
- When manually specifying worksurface of Plastic Laminate or Veneer add suffix "-S" to the code





Notes

In order to get a total cost on products when an upcharge or downcharge is present you take the list price of the product number and add the upcharge or deduct the downcharge cost shown to the list price.

For example:

Product TCTB2460 in Nuform Woodgrain would be \$573 +\$60

Product TCTB2460 in Nuform Woodgrain with a 1" Straight Edge would be \$573 +\$60 -\$58

Description	Part number	Width	Depth	1.25" Straight edge nuform solid/ laminate (base)	Nuform woodgrain/ pattern	Nuform tapered edge	1" Straight edge nuform solid	Grade 1 laminate Straight Edge only	Veneer 1.25" Straight Edge only
 Bullet Top	TCTB2460	60"	24"	\$573	+\$60	—	-\$58	+\$184	—
	TCTB2466	66"	24"	\$629	+\$63	—	-\$63	+\$202	—
	TCTB2472	72"	24"	\$686	+\$73	—	-\$72	+\$220	—
	TCTB3060	60"	30"	\$716	+\$76	—	-\$75	+\$230	—
	TCTB3066	66"	30"	\$763	+\$78	—	-\$77	+\$245	—
	TCTB3072	72"	30"	\$858	+\$88	—	-\$87	+\$275	—
 Bean Top	TB2748	48"	27"	\$429	+\$60	—	-\$58	+\$138	—
 Oval Top	TOM3048	48"	30"	\$573	+\$60	—	-\$58	+\$184	—
 Curved Rectangular Top	TCUR27405	40 1/2"	27"	\$402	+\$42	—	-\$40	+\$129	—

Left blank intentionally.

tables

Legs & Bases







Tables

Legs & Bases

Legs

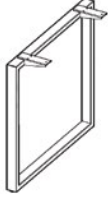





General information

- Height adjustable leg provides manual adjustability to five heights -25.5", 27", 28.5", 30", 31.5"
- Legs are available in any of Inscape's standard paint colours. Accent paint colours have an upcharge.
- To adjust the height there are two bolts that unthread and then pull out so that inner leg can then move up or down
- Round caster legs recommended to be used 2 with a brake and 2 without

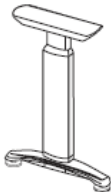
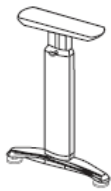
Description	Part number	Height	Depth	Weight (lbs)	Neutral paint/ base price	Accent paint	
	"H" Leg Fixed Height	THLEG2428.5	28 ½"	24"	—	\$422	+\$43
		THLEG3028.5	28 ½"	30"	—	\$445	+\$45
		THLEG3628.5	28 ½"	36"	—	\$460	+\$47
	"H" Leg Manual Adjustable Height	THLEG24-ADJ	28 ½"	24"	—	\$513	+\$52
		THLEG30-ADJ	28 ½"	30"	—	\$534	+\$54
		THLEG36-ADJ	28 ½"	36"	—	\$551	+\$56
	"O" Leg Fixed Height	TOLEG2428.5	28 ½"	24"	—	\$351	+\$36
		TOLEG3028.5	28 ½"	30"	—	\$362	+\$37
		TOLEG3628.5	28 ½"	36"	—	\$366	+\$37
	Round Caster Leg	TRNDLEGCASTER	28 ½"	—	—	\$217	+\$23
	Post Leg Visual to match Height Adjustable Table launched June 2017	INPLAK28.5	28 ½"	—	—	\$260	+\$27
	Freestanding "C" Leg for 24"D work surfaces Visual to match Height Adjustable Table launched June 2017	INLAKFLEG24LH left hand (illustrated)	28 ½"	—	—	\$301	+\$31
		INLAKFLEG24RH right hand	28 ½"	—	—	\$301	+\$31
	Freestanding "C" Leg for 30"D work surfaces Visual to match Height Adjustable Table launched June 2017	INLAKFLEG30LH left hand (illustrated)	28 ½"	—	—	\$306	+\$32
		INLAKFLEG30RH right hand	28 ½"	—	—	\$306	+\$32

General information

- Height adjustable leg provides manual adjustability to five heights -25.5", 27", 28.5", 30", 31.5"
- Legs are available in any of Inscape's standard paint colours

Description	Part number	Height	Depth	Weight (lbs)	Neutral paint/ base price	Accent paint
 "C" Leg Fixed Height	TCLEG1828.5F	28 ½"	18"	7	\$334	+\$34
 "C" Leg Manual Adjustable Height Handed	TCLEG18MLH TCLEG18MRH	— —	18" 18"	8 8	\$415 \$415	+\$42 +\$42
 "L" Leg Fixed Height	TLLEG2428.5F TLLEG3028.5F	28 ½" 28 ½"	24" 30"	7 7	\$340 \$353	+\$35 +\$36
 "L" Leg Manual Adjustable Height Handed	TLLEG24MLH TLLEG24MRH TLLEG30MLH TLLEG30MRH	— — — —	24" 24" 30" 30"	8 8 8 8	\$415 \$415 \$426 \$426	+\$42 +\$42 +\$43 +\$43
 Post Leg Fixed Height With black slide glide	TLEG28.5F	28 ½"	—	3	\$166	+\$18
 Triangular Leg	TWMLEG-28.5	28 ½"	—	—	\$224	+\$23
 Rectangular Post Leg	TRECPLEG-28.5 Fixed Height TRECPLEG-ADJ Manual Adjustable Height	28 ½" 28 ½"	— —	— —	\$144 \$241	+\$16 +\$25

Tables

Legs & Bases

Bases

General information

- Legs available in any of Inscape's standard paint colours (except cylindrical table base)
- Limited color options with Cylindrical Table Base
- Base only
- Cylindrical Table bases only for use with Round, Pebble, Racetrack and Rhombus Tops
- 2 Cylindrical Table bases required for Racetrack and Rhombus Tops

Description	Part number	Height	Weight (lbs)	Neutral paint/ base price	Accent paint
 <p>"X" Table Base Top specified separately</p>	TX-BASE30 For use with 30" and 36" W Round tops only	—	—	\$1118	+\$113
	TX-BASE36 For use with 42" and 48" W Round tops only	—	—	\$1152	+\$116

Description	Part number	Height	White	Silver
 <p>Cylindrical Table Base Available in white & silver only Top specified separately</p>	TCBASE-20	20"	\$1705	\$16
	TCBASE-28.5	28 ½"	\$1725	\$17
	TCBASE-42	42"	\$1753	\$19

tables

Accessories



Tables

Accessories

Surface Support Accessories

General information

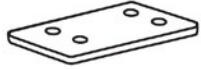
- Table link bracket is specified to link two tables together
- Stretcher bars are required to be specified with worksurfaces 54" and wider which do have any mid support
- Stretcher bars are 1 ½" high

Description	Part number	Height	Depth	Weight (lbs)	List price
 Table Link Bracket		LBRKT		—	\$64
 Flush Bracket Kit of 2		INFB		0.2	\$14
 20" Flush Bracket		INFB20		1	\$22

Description	Part number	Width	Weight (lbs)	Eco black	Painted
 Worksurface Stretcher Bar For use with worksurfaces 54" and wider	INSBK54 For use with 54" surface	44"	—	\$66	—
	INSBK60 For use with 60" surface	50"	—	\$98	—
	INSBK72 For use with 72" surface	62"	—	\$117	—
	INSBK84 For use with 84" surface	74"	—	\$140	—
	INSBK96 For use with 96" surface	86"	—	\$159	—

General information

- Table mounted screens mount to worksurfaces
- It is recommended that the Adjustable Framed Table Mounted Screen is installed to allow 20" of visual privacy
- Freestanding Table Screen is made of 6mm thick frosted acrylic which is 13" high, seated in a painted aluminum extrusion, which can be painted any of Inscape's standard colors. This screen is 5" less in depth than depth of worksurface it will be placed on
- Table Mounted Screen/Modesty has 14" of the tackboard mounted above the surface and 13 1/2" below

Notes

In order to get a total cost on products when upcharges are present take the list price of the product number and add the upcharge cost shown to the list price.

For example:

Product TMST3736 in Grade 3 Fabric would be \$529 +\$77

Product TSWTMS48 in Frosted Acrylic would be \$755 +\$89

Description	Part number	Height	Depth	Weight (lbs)	List price	Grade 2	Grade 3	Grade 4	Grade 5	Grade 6	Grade 7	Grade 8	Accent paint
	TMST3736	37"	36"	13	\$529	+\$49	+\$77	—	+\$134	—	+\$370	—	+\$54
	TMST3742	37"	42"	15	\$551	+\$50	+\$78	—	+\$134	—	+\$374	—	+\$56
	TMST3748	37"	48"	16	\$573	+\$55	+\$79	—	+\$135	—	+\$378	—	+\$58
	TMST3754	37"	54"	18	\$593	+\$57	+\$84	—	+\$138	—	+\$387	—	+\$60
	TMST3760	37"	60"	19	\$614	+\$62	+\$89	—	+\$138	—	+\$396	—	+\$62

37" H Adjustable Framed Table Mounted Screen Tackable



Description	Part number	Height	Width	Grade A	Grade B/COM	Grade C	Grade D	Grade E	Grade F	Accent paint
	INTMSF2948	29"	48"	\$1117	+\$158	+\$434	+\$842	+\$1015	+\$1387	+\$112
	INTMSF2954	29"	54"	\$1133	+\$307	+\$601	+\$1020	+\$1215	+\$1706	+\$114
	INTMSF2960	29"	60"	\$1209	+\$353	+\$680	+\$1138	+\$1356	+\$1897	+\$122

Table Mounted Screen/Modesty Tackable

Description	Part number	Height	Depth	Weight (lbs)	Clear acrylic	White acrylic	Frosted acrylic
	Table Mounted Acrylic Screen	TSWTMS48	20"	48"	4	\$755	+\$89
		TSWTMS54	20"	54"	5	\$1185	+\$186
		TSWTMS60	20"	60"	6	\$1373	+\$185

Description	Part number	Height	Depth	Weight (lbs)	Neutral paint/ base price	Accent paint	
	Freestanding Table Screen	TINSPS24	13"	19"	2	\$104	+\$12
		TINSPS30	13"	25"	2	\$146	+\$16
		TINSPS32	13"	28"	2	\$153	+\$16
		TINSPS36	13"	31"	2	\$159	+\$17

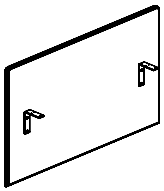
Tables

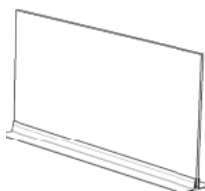
Accessories

Modesty Panels

General information

- Modesty panels are available in a variety of materials and mounting options correspond with each variety
- Modesty panels mount to the underside of worksurface and are field installed
- See Application Guide for specific dimension detailed applications
- All hardware included
- Specify modesty panels 12" shorter than the surface length when being used with a Height Adjustable Table

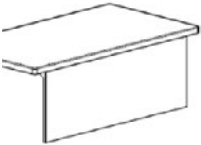
Description	Part number	Height	Width	Neutral paint/ base price	Accent paint	
	Painted Partial Height Modesty Panel	TMDPNP30	13.5"	30"	\$117	+\$13
	TMDPNP33	13.5"	33"	\$120	+\$13	
	TMDPNP36	13.5"	36"	\$122	+\$13	
	TMDPNP39	13.5"	39"	\$125	+\$14	
	TMDPNP42	13.5"	42"	\$128	+\$14	
	TMDPNP45	13.5"	45"	\$131	+\$14	
	TMDPNP48	13.5"	48"	\$137	+\$15	
	TMDPNP51	13.5"	51"	\$139	+\$15	
	TMDPNP54	13.5"	54"	\$141	+\$15	
	TMDPNP57	13.5"	57"	\$144	+\$16	
	TMDPNP60	13.5"	60"	\$146	+\$16	
	TMDPNP63	13.5"	63"	\$148	+\$16	
	TMDPNP66	13.5"	66"	\$150	+\$16	
	TMDPNP69	13.5"	69"	\$151	+\$16	
TMDPNP72	13.5"	72"	\$154	+\$17		

General information

- Modesty panels are available in a variety of materials and mounting options correspond with each variety
- Modesty panels mount to the underside of worksurface and are field installed
- See Application Guide for specific dimension detailed applications
- All hardware included
- Specify modesty panels 12" shorter then the surface length when being used with a Height Adjustable Table
- The Nuform option has a gray backer
- The laminate option is laminate on both sides with a self edge
- The veneer option is veneer on both sides with a self edge
- Nuform finish is on one side with white backer

Notes

In order to get a total cost on products when upcharges are present take the list price of the product number and add the upcharge cost shown to the list price.

For example:

Product TMDPNW30 in Veneer would be \$270 +\$130

Description	Part number	Height	Depth	Nuform	Laminate	Grade 1 laminate	Veneer	Accent paint
	Wood Core Partial Height Modesty Panel							
	TMDPNW30	13.5"	30"	\$270	\$270	+\$87	+\$130	+\$28
	TMDPNW33	13.5"	33"	\$290	\$290	+\$93	+\$130	+\$30
	TMDPNW36	13.5"	36"	\$297	\$297	+\$96	+\$144	+\$31
	TMDPNW39	13.5"	39"	\$332	\$332	+\$107	+\$128	+\$34
	TMDPNW42	13.5"	42"	\$338	\$338	+\$109	+\$143	+\$35
	TMDPNW45	13.5"	45"	\$347	\$347	+\$112	+\$156	+\$36
	TMDPNW48	13.5"	48"	\$353	\$353	+\$113	+\$178	+\$36
	TMDPNW51	13.5"	51"	\$387	\$387	+\$124	+\$164	+\$40
	TMDPNW54	13.5"	54"	\$393	\$393	+\$126	+\$184	+\$40
	TMDPNW57	13.5"	57"	\$402	\$402	+\$129	+\$196	+\$41
	TMDPNW60	13.5"	60"	\$422	\$422	+\$136	+\$196	+\$43
	TMDPNW63	13.5"	63"	\$493	\$493	+\$158	+\$147	+\$50
	TMDPNW66	13.5"	66"	\$514	\$514	+\$165	+\$147	+\$52
	TMDPNW69	13.5"	69"	\$533	\$533	+\$171	+\$148	+\$54
	TMDPNW72	13.5"	72"	\$554	\$554	+\$178	+\$155	+\$56
	TMDPNW75	13.5"	75"	\$617	\$617	+\$198	+\$113	+\$62
	TMDPNW78	13.5"	78"	\$622	\$622	+\$200	+\$130	+\$63
	TMDPNW81	13.5"	81"	\$629	\$629	+\$202	+\$143	+\$63
	TMDPNW84	13.5"	84"	\$633	\$633	+\$203	+\$160	+\$64
TMDPNW87	13.5"	87"	\$638	\$638	+\$205	+\$174	+\$64	
TMDPNW90	13.5"	90"	\$642	\$642	+\$206	+\$189	+\$65	



Tables

Accessories

Modesty Panels

General information

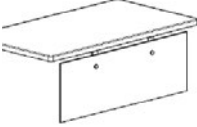
- Modesty panels are available in a variety of materials and mounting options correspond with each variety
- Modesty panels mount to the underside of worksurface and are field installed
- See Application Guide for specific dimension detailed applications
- All hardware included

Description	Part number	Height	Width	Neutral paint/ base price	Accent paint
 Acrylic Partial Height Modesty Panel	TMDPNA30	13.5"	30"	\$444	—
	TMDPNA33	13.5"	33"	\$448	—
	TMDPNA36	13.5"	36"	\$455	—
	TMDPNA39	13.5"	39"	\$460	—
	TMDPNA42	13.5"	42"	\$466	—
	TMDPNA45	13.5"	45"	\$476	—
	TMDPNA48	13.5"	48"	\$481	—
	TMDPNA51	13.5"	51"	\$501	—
	TMDPNA54	13.5"	54"	\$524	—
	TMDPNA57	13.5"	57"	\$544	—
	TMDPNA60	13.5"	60"	\$572	—
	TMDPNA63	13.5"	63"	\$598	—
	TMDPNA66	13.5"	66"	\$627	—
	TMDPNA69	13.5"	69"	\$652	—
	TMDPNA72	13.5"	72"	\$681	—
	TMDPNA75	13.5"	75"	\$694	—
	TMDPNA78	13.5"	78"	\$710	—
	TMDPNA81	13.5"	81"	\$724	—
	TMDPNA84	13.5"	84"	\$740	—
TMDPNA87	13.5"	87"	\$755	—	
TMDPNA90	13.5"	90"	\$771	—	
 Frame Frosted Acrylic Partial Height Modesty Panel	TMDPNG30	13.5"	30"	\$666	+\$67
	TMDPNG33	13.5"	33"	\$689	+\$70
	TMDPNG36	13.5"	36"	\$710	+\$72
	TMDPNG39	13.5"	39"	\$732	+\$75
	TMDPNG42	13.5"	42"	\$753	+\$77
	TMDPNG45	13.5"	45"	\$776	+\$79
	TMDPNG48	13.5"	48"	\$797	+\$81
	TMDPNG51	13.5"	51"	\$820	+\$83
	TMDPNG54	13.5"	54"	\$841	+\$85
	TMDPNG57	13.5"	57"	\$862	+\$87
	TMDPNG60	13.5"	60"	\$885	+\$90
	TMDPNG63	13.5"	63"	\$1032	+\$104
	TMDPNG66	13.5"	66"	\$1053	+\$106
	TMDPNG69	13.5"	69"	\$1075	+\$108
	TMDPNG72	13.5"	72"	\$1098	+\$111
	TMDPNG75	13.5"	75"	\$1119	+\$113
	TMDPNG78	13.5"	78"	\$1139	+\$115
	TMDPNG81	13.5"	81"	\$1163	+\$117
	TMDPNG84	13.5"	84"	\$1183	+\$119
TMDPNG87	13.5"	87"	\$1207	+\$121	
TMDPNG90	13.5"	90"	\$1229	+\$123	

General information

- Modesty panels are available in a variety of materials and mounting options correspond with each variety
- Modesty panels mount to the underside of worksurface and are field installed
- See Application Guide for specific dimension detailed applications
- All hardware included
- The Nuform option has a gray backer
- The laminate option is laminate on both sides with a self edge
- The veneer option is veneer on both sides with a self edge
- Nuform finish is on one side with white backer

Notes

In order to get a total cost on products when upcharges are present take the list price of the product number and add the upcharge cost shown to the list price.

For example:

Product TMDFHPNW30 in Veneer would be \$349 +\$221

Description	Part number	Height	Width	Nuform	Laminate	Grade 1 laminate	Veneer	Accent paint
 <p>Wood Core Full Height Modesty Panel</p>	TMDFHPNW30	24"	30"	\$349	\$349	+\$112	+\$221	+\$36
	TMDFHPNW33	24"	33"	\$380	\$380	+\$122	+\$226	+\$39
	TMDFHPNW36	24"	36"	\$388	\$388	+\$125	+\$253	+\$40
	TMDFHPNW39	24"	39"	\$443	\$443	+\$142	+\$237	+\$45
	TMDFHPNW42	24"	42"	\$452	\$452	+\$145	+\$265	+\$46
	TMDFHPNW45	24"	45"	\$404	\$404	+\$130	+\$350	+\$41
	TMDFHPNW48	24"	48"	\$470	\$470	+\$151	+\$329	+\$48
	TMDFHPNW51	24"	51"	\$582	\$582	+\$187	+\$255	+\$59
	TMDFHPNW54	24"	54"	\$592	\$592	+\$190	+\$292	+\$60
	TMDFHPNW57	24"	57"	\$600	\$600	+\$192	+\$320	+\$61
	TMDFHPNW60	24"	60"	\$616	\$616	+\$198	+\$342	+\$62
	TMDFHPNW63	24"	63"	\$642	\$642	+\$206	+\$351	+\$65
	TMDFHPNW66	24"	66"	\$659	\$659	+\$211	+\$371	+\$66
	TMDFHPNW69	24"	69"	\$678	\$678	+\$217	+\$390	+\$69
	TMDFHPNW72	24"	72"	\$691	\$691	+\$222	+\$423	+\$70
	TMDFHPNW75	24"	75"	\$789	\$789	+\$253	+\$362	+\$80
	TMDFHPNW78	24"	78"	\$795	\$795	+\$255	+\$393	+\$81
	TMDFHPNW81	24"	81"	\$800	\$800	+\$256	+\$426	+\$81
	TMDFHPNW84	24"	84"	\$805	\$805	+\$258	+\$456	+\$82
TMDFHPNW87	24"	87"	\$809	\$809	+\$259	+\$489	+\$82	
TMDFHPNW90	24"	90"	\$818	\$818	+\$262	+\$517	+\$83	

Tables

Accessories

Modesty Panels

General information

- Modesty panels are available in a variety of materials and mounting options correspond with each variety
- Modesty panels mount to the underside of worksurface and are field installed
- See Application Guide for specific dimension detailed applications
- All hardware included

Description	Part number	Height	Depth	Neutral paint/ base price	Accent paint
 Framed Frosted Acrylic Full Height Modesty Panel	TMDFHPNG30	24"	30"	\$795	+\$81
	TMDFHPNG33	24"	33"	\$826	+\$84
	TMDFHPNG36	24"	36"	\$857	+\$87
	TMDFHPNG39	24"	39"	\$890	+\$90
	TMDFHPNG42	24"	42"	\$919	+\$93
	TMDFHPNG45	24"	45"	\$952	+\$96
	TMDFHPNG48	24"	48"	\$983	+\$99
	TMDFHPNG51	24"	51"	\$1014	+\$102
	TMDFHPNG54	24"	54"	\$1046	+\$105
	TMDFHPNG57	24"	57"	\$1076	+\$108
	TMDFHPNG60	24"	60"	\$1108	+\$112
	TMDFHPNG63	24"	63"	\$1265	+\$127
	TMDFHPNG66	24"	66"	\$1297	+\$130
	TMDFHPNG69	24"	69"	\$1327	+\$133
	TMDFHPNG72	24"	72"	\$1360	+\$137
	TMDFHPNG75	24"	75"	\$1390	+\$140
	TMDFHPNG78	24"	78"	\$1423	+\$144
	TMDFHPNG81	24"	81"	\$1455	+\$147
	TMDFHPNG84	24"	84"	\$1483	+\$150
TMDFHPNG87	24"	87"	\$1516	+\$153	
TMDFHPNG90	24"	90"	\$1544	+\$156	

General information



- Grommets must be field installed
- Round Grommet = 2" diameter
- Rectangular Grommet = 3" x 5.25"
- Clamp on Power Modules have white inserts and a 72" long power cord. It attaches to 1" and 1 ¼" thick worksurfaces
- Flip-up Power & Data Module is finished with a clear anodized aluminum with white inserts and a 72" long power cord
- Arrivals Collection Mini Tap and Flip-up Module include clips and screws for basic wire management



Notes

In order to get a total cost on products when upcharges are present take the list price of the product number and add the upcharge cost shown to the list price.

For example:

Product PLNGRKIT in Stainless Steel would be +\$0 +\$72

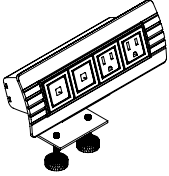
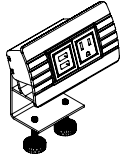
Description	Part number	Dimensions	List price	Black	White	Silver	Stainless steel
 Grommet Sleeve & Cover Kit	PLNGRKIT	5 ¼"	\$180	+\$0	—	—	+\$72
 Worksurface Grommet-PVC Sleeve & CAP	GROMMET-WS	—	\$14	+\$0	—	—	—

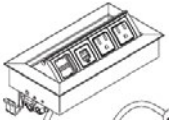
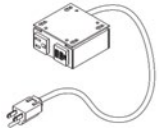
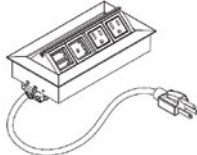
Description	Part number	Height	Width	Depth	Weight	List price
 Clamp-on Power Module 2 receptacles/2 voice/data ports	PVDMODTC	—	—	—	—	\$452
 Clamp-on Power Module 1 receptacle/1 dual USB port	PVDMODTC-1P1U	—	—	—	—	\$488
 Clamp-on Power Module 3 receptacle/1 dual USB port	PVDMODTC-3P1U	—	—	—	—	\$550
 Flip-up Power & Data Module 2 outlets + 1 dual USB + 1 data	PVDMODFL	—	—	—	—	\$786
 Arrivals Collection Mini Tap Undermount Power Module available in black only	PVDMODSMT-1P1U Single Configuration: 1 Power + 1 USB	—	—	—	—	\$322
	PVDMODDMT-1P1U Double Configuration: 1 Power + 1 USB (2 paired units)	—	—	—	—	\$631
 Arrivals Collection Flip-up Power & Data Module available in matte black, matte white and aluminium	PVDMODS-2P1U1D Single Configuration: 2 outlets + 1 duplex USB + 1 data	—	—	—	—	\$436
	PVDMODD-2P1U1D Double Configuration: 2 outlets + 1 duplex USB + 1 data (2 paired units)	—	—	—	—	\$851



Tables

Accessories

Electrical Accessories

General information

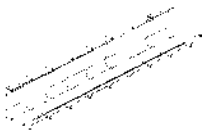
- Wire Management clips are white and attach by double sided tape which is included
- Cable Management tray is available in two lengths black only and includes mounting hardware

Description	Part number	Width	Weight (lbs)	List price
 Mesh Cable Management Tray Silver	TWMTRAY	28"	—	\$115
 Cable Management Tray	INCMT18 INCMT30	18" 30"	— —	\$31 \$39

Veil
US Price List
September 2018

Left blank intentionally.

veil

Privacy
screens

Privacy Screens

General information





- Cloak, Wave and Cove have provide visual + acoustical properties
- Pivot for use with Interval

Notes

In order to get a total cost on products when upcharges are present take the list price of the product number and add the upcharge cost shown to the list price.

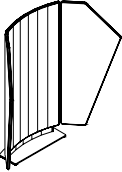
For example:

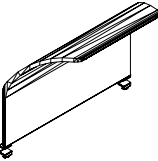
Product VLCLOAK in Grade B would be \$3473 +\$793

Description	Part number	Height	Width	Grade A/ rectangular wing base	Grade B/COM	Grade C	Grade D	Grade E	Grade F	Angled wing option
 <p>Cloak Optional rectangular or angled wings (illustrated)</p>	VLCLOAK	62"	77"	\$3473	+\$793	+\$1108	+\$1415	+\$1724	+\$2032	+\$167
 <p>Wave</p>	VLWAVE	62"	29"	\$2015	+\$280	+\$448	+\$619	+\$785	+\$956	
 <p>Cove Inside flat surface is tackable</p>	VLCOVECRV36	27"	36"	\$1511	+\$192	+\$309	+\$434	+\$559	+\$680	
 <p>Pivot</p>	VLPIVOT1080	78 Panel (102 floor to beam) "	24"	\$1968	+\$193	+\$294	+\$389	+\$485	+\$581	

veil

Seating

General information

- Ease chair designed to fit within Cloak screen

Notes

In order to get a total cost on products when upcharges are present take the list price of the product number and add the upcharge cost shown to the list price.

For example:

Product VLEASECHR in Grade B would be \$1996 +\$193

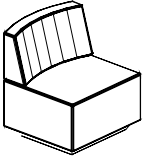
Description	Part number	Height	Width	Grade A	Grade B/COM	Grade C	Grade D	Grade E	Grade F
	VLEASECHR	31"	28"	\$1996	+\$193	+\$294	+\$385	+\$481	+\$577

Ease
Upholstered seat
with back

	VLEASEOTTOCU	17"	28"	\$1507	+\$117	+\$171	+\$226	+\$280	+\$337
--	---------------------	-----	-----	--------	--------	--------	--------	--------	--------

Ease upholstered
ottoman, curved

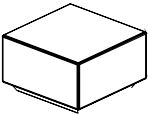
	VLEASEOTTOST	17"	28"	\$1542	+\$144	+\$207	+\$269	+\$336	+\$402
---	---------------------	-----	-----	--------	--------	--------	--------	--------	--------

Ease upholstered
ottoman, straight

Finishes
US Price List
September 2018

Finishes

Inscape system frames

Inscape System frames are powder-coated in scuff-resistant Eco-black epoxy. Clips, plates, plugs and bracketry are finished in black.

Trims

Trims are available epoxy powder-coated in a smooth or textured finish. In Addition, veneer trim is available in the same applications/

Worksurfaces

Worksurfaces are available in Nuform solid, Nuform woodgrain, laminate and veneer.

Nuform

Nuform is a themofoil sheet that is continuously bonded to an MDF substrate. The sheet is surface-coated with a scratch resistant film. The underside of the worksurface is finished with low-pressure melamine. Nuform worksurfaces have optional pencil groove. No edge banding is required with Nuform because of its unique design, which wraps the foil to the underside of the worksurface. This eliminates the need for edge banding. Nuform is also available on tiles (ensure the application is reviewed for rules).

Nuform Solid

Colorways	Product code
Warm White	F121
Mist	F122
Sandstone	F123
Frosty White	F127
Designer White	F129

Nuform Woodgrain

Colorways	Product code
Walnut*	F06
Tannery Maple	F08
Honey Brown	F09
Musique Maple	F10
Jewel Cherry	F11
River Cherry	F16
Obsidian Oak	F34
Palos Mahogany	F35
Ash White	F37
Espresso	F38
Ash Espresso	F39
Swiss Elm	F40
Antique Whitewash	F41
Blonde Maple	F42
Barn Board	F43
Brazilian Nut	F44
Rustic Plank	F45

***F06 Walnut has a maximum material width of 46" where all other Nuform is 48". This finish can not be used on surfaces larger than 42"d.**

Laminate

Laminate is bonded to 1.25" thick particleboard. The underside of the worksurface is finished with a wood-fiber veneer backer. Worksurfaces specified with a laminate finish include a 2mm edge banding in a coordinating color. Plastic laminate tops do not have optional pencil groove.

Laminate

Standard laminate finishes are prefixed with 'LCC' and standard low laminate storage finishes are prefixed with 'MCC'.

Colorways	Product code	Edge color
Wild Cherry	LCC01	Rustic Cherry
Maple	LCC02	Fusion Maple
White	LCC07	Designer White
Pumice	LCC08	Beige
Antique White	LCC09	Warm White
Gray	LCC12/ MCC009	Folk Stone
Madagascar	LCC14	Madagascar
Asian Sand	LCC15	Asian Sand
River Cherry	LCC16	River Cherry
Wenge	LCC17	Wenge
Elegant White	LCC19	Frosty White
Neowalnut	LCC23	Neowalnut
Mangalore Mango	LCC29	Mangalore Mango
Pearwood	LCC30	Pearwood
Black	LCC33/ MCC012	Black
Walnut Heights	LCC35	Walnut Heights
Studio Teak	LCC36	Studio Teak
Slate Gray	LCC41	Slate Gray
Raven	LCC42	Raven
Dalia	LCC43/ MCC007	Dalia
Mimosa	LCC44/ MCC008	Mimosa
Inspiration	LCC45/ MCC010	Inspiration
Nova White	LCC46/ MCC001	Designer White
Storm	LCC47/ MCC011	Storm
White Lace	LCC48/ MCC013	White Lace
Chill	LCC49/ MCC014	Chill
Spring Blossom	LCC50/ MCC015	Spring Blossom

Colorways	Product code	Edge color
Haze	LCC51/ MCC016	Haze
Dover White	LCC52	Dover White
Graphite	LCC53	Graphite

LCC-18 is available but is reserved for existing customers due to its different edge banding.

Grade 1 Laminate

Colorways	Product code	Edge color
Elegant White	L1C001	Plywood
Black	L1C002	Plywood
Slate Gray	L1C003	Plywood
Raven	L1C004	Plywood
White Ash	L1C005	White Ash
Weathered Ash	L1C006	Weathered Ash
Finnish Oak	L1C007	Finnish Oak
Fawn Cypress	L1C008	Fawn Cypress

Grade 2 Laminate

Colorways	Product code	Edge color
Natural Grain	L2C001	Natural Grain

Veneer

Veneer thickness is 0.025". Overall thickness of the tops is 1.25". The stain color is permeated throughout the veneer for color consistency. The open pore veneer is clear coated with a lacquer utilizing a multi-step process and has a gloss value of 45° when dry. Tops are constructed utilizing 45 lbs density particle board with an engineered balanced backer for structural integrity. Tops are edged in 3mm thick same species veneer and do not include a pencil groove. Grain direction on tiles and storage fronts is vertical. Direction on worksurfaces is along the length. Available in Natural and Composite.

Composite Veneer

For worksurfaces, tiles and storage fronts.

Colorways	Product code
Cherry	VC001
Maple	VC002
Wenge	VC003

Composite veneer is the only option when veneer is available on trim and connectors.

Note: Veneer is not available as on transaction top trim and Add on Glaze trim.

Natural Veneer*

Colorways	Product code
Natural Cherry	VN001
Standard Cherry	VN002
Natural Maple	VN003
Cape Coast Walnut	VN004
Natural Walnut	VN005

*Natural Veneer finishes are not available on tiles and storage fronts.

Note: Custom stains on veneers are available at an additional 20% upcharge and extra lead time. Due to the natural variations of wood products, Inscape can not guarantee the exact matching of color or grain patterns.

Plywood

Is currently only available on the Bench Arrivals Collection worksurface mount screen, upmount shelf screen and wing.

Colorways	Product code
Clear Coat Maple	VP001

Wood Legs

These legs are available on the Bench Arrivals Collection, Arrivals Tables Collection and Wing.

Colorways	Product code
Clear Oak	CLROAK
Black Oak	BLKOAK
Clear Maple	CLRMPL

Acrylic

Colorways	Product code
Clear	CA
Frosted	FA
White	WH

Polycarbonate

Colorways	Product code
Clear	CP
White	WP

Glass

Colorways	Product code
Clear	CL
Etched 1 Side	ET1
Etched 2 Sides	ET2
Grey	GRY

Tiles

Inscape System and Bench tiles are available fabric wrapped, epoxy powder coated, in Nuform and veneer finishes. Nuform woodgrain tiles may be specified in finishes same as worksurfaces. Grain direction in Nuform and veneer is vertical. Tiles may be covered with our standard fabrics, or covered with COM. Use of any COM must be approved by Inscape prior to acceptance of order. Refer to “Conditions of Sale, Orders involving Customer’s Own Material (COM)”. Fabrics with an asterisk* below, as well as any transparent (typically light colored) COM fabrics, will be subject to an upcharge due to additional costs associated with the manufacturing of the tile to eliminate transparency. The upcharge is included in specification tools, or through your Client Services Representative.

Fabric wrapped tiles, including tackable and tackable acoustical tiles, are available in a variety of standard fabrics as well as COM. COM fabrics are subject to approval. White or extremely light colored COM fabrics will incur an upcharge of 25% to the tile pricing with which the fabric is being applied. This is due to special handling of the fabric and tiles, in addition to painting of the tiles. Light colored fabrics include; but are not limited to:

Anchorage

Part of the Focus Fabric Collection

Colorways	Product code
White	U1437

Off The Grid

Part of the Focus Fabric Collection

Colorways	Product code
Lava	U3110
Steam	U3112
Thermal	U3113
Solar	U3114
Fossil	U3116
Earthglow	U3117

Gamut

Part of the Focus Fabric Collection

Colorways	Product code
Chalk	U3300
Vanilla	U3301
Custard	U3302
Sky	U3316
Celadon	U3324
Mist	U3338
Pumice	U3339
Pebble	U3340

Fabric patterns which are available in 54” and 55” width both have limitations on the sizes of tiles available. When being applied “Off the Blot” tile sizes longer than 42” are not available.

Patterns include: Gamut, Ellipsis, Vivid and Rocket

Finishes

Vertical Surface Fabric Fabric Collection

Grade 1 Fabrics

Anchorage

Colorways	Product code
Green Apple	U1400
Red Delicious	U1401
Onyx	U1402
Slate	U1403
Amber	U1404
Willow	U1405
Flax	U1406
Angora	U1407
Green Olive	U1412
Goose	U1413
Cumin	U1414
Deep Water	U1415
Quarry Blue	U1416
Midnight	U1417
Sunshine	U1419
Asteroid	U1421
Coffee Bean	U1425
Geranium	U1426
Thistle	U1427
Chocolate	U1431
Lapis	U1432
Vanilla	U1434
Pumpkin	U1435
Wolf	U1436
White	U1437

Netiquette

Colorways	Product code
Bitmap	U1350
Chipset	U1351
Dashboard	U1352
Analog	U1353
Schema	U1354
Inkjet	U1355
Vector	U1356
Gamma	U1357
Refresh	U1358
Pixel	U1359

Pebble

Colorways	Product code
Sindari	U1535
Nice	U1536
Waikiki	U1537
Siesta	U1538
South Beach	U1539
Schoolhouse	U1540
Mabua	U1541
Langkawi	U1542
Tenerife	U1543
Cape Cod	U1544
Maybay	U1545
Surfers Paradise	U1546
Negril	U1547
Papakolea	U1548
Chesil	U1549
Red Beach	U1550
Copacabana	U1551

Whisper

Colorways	Product code
Dim	U1485
Ambience	U1486
Silence	U1487
Tranquility	U1488
Hush	U1489
Zen	U1490
Stillness	U1491
Mute	U1492
Serenity	U1493
Quiet	U1494
Muffle	U1495
Cloud	U1496
Lull	U1497
Reserve	U1498
Peep	U1499
Baffle	U1500
Mellow	U1501
Placid	U1502
Chant	U1503
Secret	U1504
Mum	U1505
Undertone	U1506
Mystery	U1507
Spirit	U1508

Meander

Colorways	Product code
Sandshell	U1061
Overcast	U1062
Agate Taupe	U1063
Nightshadow	U1064

Universe

Colorways	Product code
Crème Brulee	U1000
Grey Mist	U1001
Wheat	U1002
Seneca	U1003
Milkyway	U1004
Mica	U1005
Cosmic	U1006
Depth	U1007

Quattro

Colorways	Product code
Chalk	U1889
Deep Crimson	U1890
Golden Orange	U1891
Granite	U1892
Hibiscus	U1893
Honeycomb	U1894
Khaki	U1895
Laguna	U1896
Leaf	U1897
Mallard	U1898
Mercury	U1899
Midnight Blue	U1900
Pumice	U1901
Skyway	U1902
Spring Green	U1903
Umber	U1904
Wheat	U1905

Cross Check

Colorways	Product code
Biscuit	U1552
Blue Ribbon	U1553
Bottle	U1554
Dove	U1555
Evergreen	U1556
Imperial	U1557
Lime	U1558
Marine	U1559
Otter	U1560
Paradise	U1561
Peacock	U1562
Platinum	U1563
Plumberry	U1564
Red Baron	U1565
Slate Black	U1566
Stone	U1567
Sunshine	U1568
Taupe	U1569
Vermillion	U1570

Grade 2 Fabric

Cameo

Colorways	Product code
Almond	U2110
Metal	U2111
Ivory	U2112
Coffee	U2113
Smoke	U2114
Stone	U2115
Mist	U2116

Pronto Solid

Colorways	Product code
Drift	U1200
Windblown	U1201
Erosion	U1202
Clear Sky	U1210
Raven	U1215
Darkness	U1220
Breeze	U1280

Punch Card

Colorways	Product code
Alabaster	U2060
Carbon	U2061
Putty	U2062
Silver Lining	U2063
Crisp	U2064
Sky	U2065
Crimson	U2066
Orange	U2067
Navy	U2068
Cadet	U2069
Burgundy	U2070
Peat	U2071
Abys	U2072

Curtain Call

Colorways	Product code
Latte	U2100
Desert	U2101
Dove	U2102
Pebble	U2103
Tawny	U2104
Sea	U2105

Proverb

Colorways	Product code
Anchor	U1740
Armor	U1741
Basalt	U1742
Buff	U1743
Cinder	U1744
Crystal	U1745
Linen	U1746
Mist	U1747
Oyster	U1748
Rye	U1749
Steel	U1750
Storm	U1751

Pact

Colorways	Product code
Putty	U2175
Calla	U2176
Eureka	U2177
Lime	U2178
Coastal	U2179
Nectar	U2180
Dragon	U2181
Toasty	U2182
Fern	U2183
Azure	U2184
Delft	U2185
Rubine	U2186
Taupe	U2187
Dove	U2188
Aloe	U2189
Harbour	U2190
Tanzanite	U2191
Roma	U2192
Lily	U2193
Sketch	U2194
Patina	U2195
Roast	U2196
Midnight	U2197

Glint

Colorways	Product code
Barley	U1658
Caspian	U1659
Column	U1660
Gobi	U1661
Gypsum	U1662
Note	U1663
Pearl	U1664
Pumice	U1665
Relic	U1666
Rune	U1667
Serene	U1668
Shale	U1669
Sisal	U1670
Turret	U1671
Vera	U1672

Script

Colorways	Product code
Almond	U1752
Charcoal	U1753
Feldspar	U1754
Flint	U1755
Nectar	U1756
Patina	U1757
Pebble	U1758
Sand	U1759
Shadow	U1760
Slate	U1761
Sterling	U1762
Taupe	U1763
Zinc	U1764

Grade 3 Fabric

Dashing

Colorways	Product code
Antique Sage	U3180
Bespoke Tan	U3181
Dapper Grey	U3182
Genteel Beige	U3183
Polish Slate	U3184
Refine Marble	U3185
Classic Silver	U3186

Gamut

Colorways	Product code
Chalk	U3300
Vanilla	U3301
Custard	U3302
Nutmeg	U3303
Sumatra	U3304
Porcini	U3305
Toffee	U3306
Canary	U3307
Mango	U3308
Butterscotch	U3309
Fire Engine	U3310
Peony	U3311
Brick	U3312
Cherry	U3313
Port	U3314
Raspberry	U3315
Sky	U3316
Cerulean	U3317
Pool	U3318
Macaw	U3319
Deep Ocean	U3320
Spruce	U3321
Navy	U3322
Ink	U3323
Celadon	U3324
Citron	U3325
Olive	U3326
Kelly	U3327
Apple	U3328
Moss	U3329
Hunter	U3330
Azalea	U3331
Eggplant	U3332
Plum	U3333
Concord	U3334
Solar	U3335
Pumpkin	U3336
Persimmon	U3337
Mist	U3338
Pumice	U3339
Pebble	U3340

Off the Grid

Colorways	Product code
Lava	U3110
Flora	U3111
Steam	U3112
Thermal	U3113
Solar	U3114
Woodchip	U3115
Fossil	U3116
Earthglow	U3117
Hydro	U3118
Flame	U3119
Tidal	U3120

Finishes

Vertical Surface Fabric Fabric Collection

Grade 3 Fabric Continued

Millennium

Colorways	Product code
Aglow	U1628
Amber	U1629
Anchor	U1630
Cascade	U1631
Cavern	U1632
Cerise	U1633
Clean	U1634
Coastal	U1635
Copper	U1636
Crisp	U1637
Electric	U1638
Geode	U1639
Lush	U1640
Mocha	U1641
Monument	U1642
Nector	U1643
Onyx	U1644
Orchid	U1645
Peridot	U1646
Plateau	U1647
Pool	U1648
Pyrite	U1649
Safari	U1650
Sapphire	U1651
Spark	U1652
Steel	U1653
Tanzanite	U1654
Thrill	U1655
Voyage	U1656
Zinc	U1657

Odyssey

Colorways	Product code
Alloy	U1765
Amp	U1766
Breeze	U1767
Captain	U1768
Carbon	U1769
Cedar	U1770
Craft	U1771
Cruise	U1772
Dijon	U1773
Eggplant	U1774
Emerald	U1775
Fossil	U1776
Ink	U1777
Inlet	U1778
Iris	U1779
Kiss	U1780
Linen	U1781
Lively	U1782
Maritime	U1783
Nettle	U1784
Oliver	U1785
Opaque	U1786
Primary	U1787
Roast	U1788
Rue	U1789
Sangria	U1790
Skim	U1791
Smith	U1792
Tinge	U1793
Western	U1794

Tradition

Colorways	Product code
Ash	U1795
Branch	U1796
Class	U1797
Distant	U1798
Flirt	U1799
Fronid	U1800
Grain	U1801
Hedge	U1802
Hidden	U1803
Isle	U1804
Jazz	U1805
Kelly	U1806
Latte	U1807
Malbec	U1808
Miller	U1809
Mist	U1810
Peel	U1811
Plated	U1812
Regal	U1813
Sly	U1814
Soar	U1815
Soy	U1816
Spiced	U1817
Sprout	U1818
Sterling	U1819
Sun	U1820
Tango	U1821
Theater	U1822
Wash	U1823
Weld	U1824

BeeHave

Colorways	Product code
Azure	U1825
Black	U1826
Carnelian	U1827
Clementine	U1828
Concord	U1829
Currant	U1830
Gris	U1831
Java	U1832
Lapis	U1833
Lemon	U1834
Pear	U1835
Pine	U1836
Plum	U1837
Slate	U1838

Cadence

Colorways	Product code
Citrine	U1863
Coral	U1864
Garnet	U1865
Jade	U1866
Jet	U1867
Lapis	U1868
Opal	U1869
Pearl	U1870
Peridot	U1871
Quartz	U1872
Ruby	U1873
Sapphire	U1874
Topaz	U1875
Turquoise	U1876

Optic

Colorways	Product code
Ash	U1907
Brown Bear	U1908
Coal	U1909
Elephant	U1910
Fieldstone	U1911
Green Apple	U1912
Mulberry	U1913
Mushroom	U1914
Ocean	U1916
Red	U1917
Springtime	U1918
Sunrise	U1919
Tangerine	U1920
Yale	U1921

Prism

Colorways	Product code
Alabaster	U1690
Asparagus	U1691
Café Au Lait	U1692
Caramel	U1693
Caribbean	U1694
Cerulean	U1695
Charcoal	U1696
Claret	U1697
Clay	U1698
Clementine	U1699
Cornflower	U1700
Dove	U1701
Espresso	U1702
Indigo	U1703
Kale	U1704
Lipstick	U1705
Mocha	U1706
Olive	U1707
Onyx	U1708
Plum	U1709
Raisin	U1710
Stone	U1711
Tomato	U1712
Topaz	U1713
Zinc	U1714

Grade 4 Fabric

Vivid

Colorways	Product code
Soapstone	U4050
Mocha	U4051
Cocoa	U4052
Citrus	U4053
Chamois	U4054
Crimson	U4055
Holly	U4056
Ultramarine	U4057
Blue Jay	U4058
Quince	U4059
Parrot	U4060
Hunter	U4061
Mulberry	U4062
Grape	U4063
Blood Orange	U4064
Pumice	U4065
Concrete	U4066
Onyx	U4067

Grade 5 Fabric

Sprite

Colorways	Product code
Linen	U5000
Powder	U5001
Khaki	U5002
Kiwi	U5003
Harvest	U5004
Snow	U5005

Union Cloth

Colorways	Product code
White	UW1201
Light Taupe	UW1202
Gold	UW1203
Medium Brown	UW1204
Husk	UW1205
Red	UW1206
Light Turquoise	UW1207
Turquoise	UW1208
Navy	UW1209
Chartreuse	UW1210
Orange	UW1211
Light Grey	UW1212
Medium Grey	UW1213
Charcoal	UW1214
Black	UW1215

Grade 6 Fabric

Crossweave

Colorways	Product code
Flax	UW1101
Antelope	UW1102
Mountain	UW1103
Straw	UW1104
Cantaloupe	UW1105
Tangelo	UW1106
Shiraz	UW1107
Flower	UW1108
Alfalfa	UW1109
Parsley	UW1110
Freshwater	UW1111
Lake	UW1112
Atlantic	UW1113
Soapstone	UW1114
Penguin	UW1115
Seal	UW1116

Grade 7 Fabric

Hem Stitch

Colorways	Product code
Crème	UW2001
Antelope	UW2002
Husk	UW2003
Island	UW2005
Summer	UW2006
Dark Sky	UW2007
Chartreuse	UW2008
Leaf	UW2009
Tangerine	UW2010
Campfire	UW2011
Dove	UW2012
Walrus	UW2014

Finishes

Cushion Upholstery Fabric

Fabric Collection

- Open House is an upholstery version of our graded Anchorage panel fabric. You can color match with your panel tile selection by choosing the 'same name' color from the Open House collection.
- CAL 133 - there is a \$30 unit net upcharge for CAL 133 fire retardant treatment on mobile pedestal cushions.
- COL 'Customers' Own Leather - COL is available and will be quoted on a per order basis.
- Contrasting Top Stitching - 'White' contrasting top stitching is available at 'no upcharge'. Please specify at time of order placement.

Grade A Open House

Pattern	Product code
Green Apple	U1400
Red Delicious	U1401
Onyx	U1402
Slate	U1403
Amber	U1404
Willow	U1405
Straw	U1406
Angora	U1407
Green Olive	U1412
Goose	U1413
Cumin	U1414
Deep Water	U1415
Quarry Blue	U1416
Midnight	U1417
Sunshine	U1419
Asteroid	U1421
Coffee Bean	U1425
Geranium	U1426
Thistle	U1427
Fossil	U1431
Lapis	U1432
Vanilla	U1434
Pumpkin	U1435
Wolf	U1436
Birch	UC2086
Eucalypt	UC2088
Graphite	UC2090
Cobalt	UC2091
Mulberry	UC2092
Pineneedle	UC2095
Aubergine	UC2096

Pebble

Pattern	Product code
Sindari	U1535
Nice	U1536
Waikiki	U1537
Siesta	U1538
South Beach	U1539
Schoolhouse	U1540
Mabua	U1541
Langkawi	U1542
Tenerife	U1543
Cape Cod	U1544
Maybay	U1545
Surfers Paradise	U1546
Negril	U1547
Papakolea	U1548
Chesil	U1549
Red Beach	U1550
Copacabana	U1551

Punch Card

Pattern	Product code
Alabaster	U2060
Carbon	U2061
Putty	U2062
Silver Lining	U2063
Crisp	U2064
Sky	U2065
Crimson	U2066
Orange	U2067
Navy	U2068
Cadet	U2069
Burgundy	U2070
Peat	U2071
Abyss	U2072

Vivid

Pattern	Product code
Soapstone	U4050
Mocha	U4051
Cocoa	U4052
Citrus	U4053
Chamois	U4054
Crimson	U4055
Holly	U4056
Ultramarine	U4057
Blue Jay	U4058
Quince	U4059
Parrot	U4060
Hunter	U4061
Mulberry	U4062
Grape	U4063
Blood Orange	U4064
Pumice	U4065
Concrete	U4066
Onyx	U4067

Quattro

Pattern	Product code
Chalk	U1889
Deep Crimson	U1890
Golden Orange	U1891
Granite	U1892
Hibiscus	U1893
Honeycomb	U1894
Khaki	U1895
Laguna	U1896
Leaf	U1897
Mallard	U1898
Mercury	U1899
Midnight Blue	U1900
Pumice	U1901
Skyway	U1902
Spring Green	U1903
Umber	U1904
Wheat	U1905
Onyx	U4067

Cross Check

Pattern	Product code
Biscuit	U1552
Blue Ribbon	U1553
Bottle	U1554
Dove	U1555
Evergreen	U1556
Imperial	U1557
Lime	U1558
Marine	U1559
Otter	U1560
Paradise	U1561
Peacock	U1562
Platinum	U1563
Plumberry	U1564
Red Baron	U1565
Slate Black	U1566
Stone	U1567
Sunshine	U1568
Taupe	U1569
Vermillion	U1570

Proverb

Pattern	Product code
Anchor	U1740
Armor	U1741
Basalt	U1742
Buff	U1743
Cinder	U1744
Crystal	U1745
Linen	U1746
Mist	U1747
Oyster	U1748
Rye	U1749
Steel	U1750
Storm	U1751

Glint

Pattern	Product code
Barley	U1658
Caspian	U1659
Column	U1660
Gobi	U1661
Gypsum	U1662
Note	U1663
Pearl	U1664
Pumice	U1665
Relic	U1666
Rune	U1667
Serene	U1668
Shale	U1669
Sisal	U1670
Turret	U1671
Vera	U1672

Grade A Continued

Script

Pattern	Product code
Almond	U1752
Charcoal	U1753
Feldspar	U1754
Flint	U1755
Nectar	U1756
Patina	U1757
Pebble	U1758
Sand	U1759
Shadow	U1760
Slate	U1761
Sterling	U1762
Taupe	U1763
Zinc	U1764

Millennium

Pattern	Product code
Aglow	U1628
Amber	U1629
Anchor	U1630
Cascade	U1631
Cavern	U1632
Cerise	U1633
Clean	U1634
Coastal	U1635
Copper	U1636
Crisp	U1637
Electric	U1638
Geode	U1639
Lush	U1640
Mocha	U1641
Monument	U1642
Nector	U1643
Onyx	U1644
Orchid	U1645
Peridot	U1646
Plateau	U1647
Pool	U1648
Pyrite	U1649
Safari	U1650
Sapphire	U1651
Spark	U1652
Steel	U1653
Tanzanite	U1654
Thrill	U1655
Voyage	U1656
Zinc	U1657

BeeHive

Pattern	Product code
Azure	U1825
Black	U1826
Carnelian	U1827
Clementine	U1828
Concord	U1829
Currant	U1830
Gris	U1831
Java	U1832
Lapis	U1833
Lemon	U1834
Pear	U1835
Pine	U1836
Plum	U1837
Slate	U1838

Odyssey

Pattern	Product code
Alloy	U1765
Amp	U1766
Breeze	U1767
Captain	U1768
Carbon	U1769
Cedar	U1770
Craft	U1771
Cruise	U1772
Dijon	U1773
Eggplant	U1774
Emerald	U1775
Fossil	U1776
Ink	U1777
Inlet	U1778
Iris	U1779
Kiss	U1780
Linen	U1781
Lively	U1782
Maritime	U1783
Nettle	U1784
Oliver	U1785
Opaque	U1786
Primary	U1787
Roast	U1788
Rue	U1789
Sangria	U1790
Skim	U1791
Smith	U1792
Tinge	U1793
Western	U1794

Tradition

Pattern	Product code
Ash	U1795
Branch	U1796
Class	U1797
Distant	U1798
Flirt	U1799
Fronde	U1800
Grain	U1801
Hedge	U1802
Hidden	U1803
Isle	U1804
Jazz	U1805
Kelly	U1806
Latte	U1807
Malbec	U1808
Miller	U1809
Mist	U1810
Peel	U1811
Plated	U1812
Regal	U1813
Sly	U1814
Soar	U1815
Soy	U1816
Spiced	U1817
Sprout	U1818
Sterling	U1819
Sun	U1820
Tango	U1821
Theater	U1822
Wash	U1823
Weld	U1824

Cadence

Pattern	Product code
Citrine	U1863
Coral	U1864
Garnet	U1865
Jade	U1866
Jet	U1867
Lapis	U1868
Opal	U1869
Pearl	U1870
Peridot	U1871
Quartz	U1872
Ruby	U1873
Sapphire	U1874
Topaz	U1875
Turquoise	U1876

Optic

Pattern	Product code
Ash	U1907
Brown Bear	U1908
Coal	U1909
Elephant	U1910
Fieldstone	U1911
Green Apple	U1912
Mulberry	U1913
Mushroom	U1914
Ocean	U1916
Red	U1917
Springtime	U1918
Sunrise	U1919
Tangerine	U1920
Yale	U1921

Prism

Pattern	Product code
Alabaster	U1690
Asparagus	U1691
Café Au Lait	U1692
Caramel	U1693
Caribbean	U1694
Cerulean	U1695
Charcoal	U1696
Claret	U1697
Clay	U1698
Clementine	U1699
Cornflower	U1700
Dove	U1701
Espresso	U1702
Indigo	U1703
Kale	U1704
Lipstick	U1705
Mocha	U1706
Olive	U1707
Onyx	U1708
Plum	U1709
Raisin	U1710
Stone	U1711
Tomato	U1712
Topaz	U1713
Zinc	U1714

Grade A Continued

Intuition

Pattern	Product code
Admiral	U1849
Bisque	U1850
Charcoal	U1851
Coral	U1852
Hickory	U1853
Honey	U1854
Ochre	U1855
Peacock	U1856
Platinum	U1857
Sage	U1858
Sand	U1859
Scarlet	U1860
Slate	U1861
Viridian	U1862

Fedora

Pattern	Product code
Aegean	U1583
Aquamarine	U1584
Bitumen	U1585
Cactus	U1586
Charcoal	U1587
Citron	U1588
Dapper	U1589
Dew	U1590
Espresso	U1591
Eucalyptus	U1592
Fawn	U1593
Indigo	U1594
Light Grey	U1595
Midnight	U1596
Mink	U1597
Opal	U1598
Persimmon	U1599
Pewter	U1600
Plumberry	U1601
Purple	U1602
Ruby	U1603
Tangelo	U1604
Tomato	U1605
Topaz	U1606
Winter	U1607

Ranchero

Pattern	Product code
Basil	U1922
Black	U1923
Brandy	U1924
Chocolate	U1925
Driftwood	U1926
Ecru	U1927
Greige	U1928
Lipstick	U1929
Navy	U1930
Nickel	U1931
Sapphire	U1932
Sepia	U1933
Slate	U1934
Thunder	U1935

Florentino

Pattern	Product code
Bark	U1936
Basil	U1937
Biscuit	U1938
Bluejay	U1939
Caramel	U1940
Chili	U1941
Cream	U1942
Dijon	U1943
Dove	U1944
Fern	U1945
Jet	U1946
Jonquil	U1947
Khaki	U1948
Latte	U1949
Lipstick	U1950
Mango	U1951
Marine	U1952
Mocha	U1953
Mushroom	U1954
Plum	U1955
Sable	U1956
Sapphire	U1957
Scarlet	U1958
Sepia	U1959
Slate	U1960
Turquoise	U1961
Willow	U1962

Key Largo

Pattern	Product code
Aegean	U1968
Cayenne	U1969
Chocolate	U1970
Crimson	U1971
Ebony	U1972
Gold Coast	U1973
Graphite	U1974
Jonquil	U1975
Jungle	U1976
Khaki	U1977
Nassau	U1978
Palm	U1979
Parchment	U1980
Pear	U1981
Quarry	U1982
Raspberry	U1983
Sand	U1984
Sandstone	U1985
Tangerine	U1986
Toast	U1987
Ultramarine	U1988
Wheat	U1989

Grade B

Crossweave

Pattern	Product code
Flax	UW1101
Antelope	UW1102
Mountain	UW1103
Straw	UW1104
Cantaloupe	UW1105
Tangelo	UW1106
Shiraz	UW1107
Flower	UW1108
Alfalfa	UW1109
Parsley	UW1110
Freshwater	UW1111
Lake	UW1112
Atlantic	UW1113
Soapstone	UW1114
Penguin	UW1115
Seal	UW1116

Quadrille

Pattern	Product code
Fair	UC1001
Cabaret	UC1002
Gambol	UC1003
Leisure	UC1004
Regalia	UC1005
Spring	UC1006
Zest	UC1007
Fiesta	UC1008
Carnival	UC1009
Spree	UC1010
Jubilee	UC1011
Opus	UC1012
Masquerade	UC1013
Soiree	UC1014
Revelry	UC1015
Escapade	UC1016
Shenanigan	UC1017

Hem Stitch

Pattern	Product code
Crème	UW2001
Antelope	UW2002
Husk	UW2003
Island	UW2005
Summer	UW2006
Dark Sky	UW2007
Chartreuse	UW2008
Leaf	UW2009
Tangerine	UW2010
Campfire	UW2011
Dove	UW2012
Walrus	UW2014

Evoke

Pattern	Product code
Breeze	U1877
Cerise	U1878
Flax	U1879
Graphite	U1880
Grey Mist	U1881
Iris	U1882
Mahogany	U1883
Natural	U1884
Noir	U1885
Pacific	U1886
Pear	U1887
Terracotta	U1888

Tweed Multi

Pattern	Product code
Taupe	UW1001
Tan	UW1002
Dark Taupe	UW1003
Yellow	UW1004
Pink	UW1005
Flame	UW1006
Medium Blue	UW1007
Turquoise	UW1008
Dark Blue	UW1009
Green	UW1010
Orange	UW1011
Light Grey	UW1012
Medium Grey	UW1013

Finishes

Cushion Upholstery Fabric

Fabric Collection

Grade C

Boucle Two-Tone

Pattern	Product code
Crème	UW3001
Mocha	UW3002
Dark Taupe	UW3003
Dark Brown	UW3004
Yellow	UW3005
Fuchsia	UW3006
Shiraz	UW3007
Lake	UW3008
Cornflower	UW3009
Sapphire	UW3010
Snap Pea	UW3011
Conifer	UW3012
Flame	UW3013
Storm	UW3014
Charcoal	UW3015

Grade D

Tiny Herringbone

Pattern	Product code
Tan	UW4201
Brown	UW4202
Blue Green	UW4203
Blue	UW4204
Medium Grey	UW4205
Dark Charcoal	UW4206

Paint code matrix

Painted System and Bench components include; tiles, trim, support brackets, accessories, legs and storage.

The following prefixes will be referenced on order acknowledgements:

E	indicates standard paint on all filing and storage items
ET	indicates standard textured paint on all filing and storage items, a 10% upcharge is applicable to the net value of the product
EA	indicates standard accent paint on all filing and storage items
P	indicates standard paint on all other items
PT	indicates standard textured paint on all other items, a 10% upcharge is applicable to the net value of the product
PA	indicates standard accent paint on all other items

Custom colors

Inscape offers color matched to a customers' specification when possible. This matching is done through a database of over 2,500 existing color formulas or the development of a new custom color. A minimum order value of \$3,000 net per custom color, applies to each order. A \$250 net fee applies for each custom color below this minimum. In addition, Custom Premium colors (bright whites and bright colors; textured paints; and reflection paints that use mica, aluminum or special materials to create their reflective properties) will be subject to a 10% upcharge to the net value of the product.

Multi-color cabinets

For multi-color cabinets where the case is one color and the drawer fronts are a second color, the following upcharge applies: Quantities of 15 or more units, add \$250 list per color. Quantities less than 15 units add \$500 list per color. (Tie bars and reference shelves will be painted the same color as the fronts.)

Note: Multi-color cabinets are not available on 7900 Series.

Neutral paint collection

Name	Color code	Textured colors
Bisque	004	
Chinook	010	
Onyx	013	
Frost	022	
Arctic	023	
Champagne	024	
Titanium	052	
Mushroom	055	
Krypton Reflections	063	
Cinder Reflections	066	
Soapstone	112	
Warm White	121	
Mist	122	
Sandstone	123	
Light Taupe	124	
Medium Gray	126	
Nickel Reflections	127	
Slate Reflections	128	
Quartz	160	
Glacier White	168	
Charcoal Gray	205	
Pebble Gray	217	
Deep White	223	
Mocha	255	
Latte	274	
Juniper Reflections	281	
Quicksilver Reflections	282	
Sunstone Reflections	284	
Aluminum Leaf	290	
Sasha	300	
Elson	301	
Shade	302	
Anonymous	303	
Urban	304	
Dorian	305	
Dover	306	
Jubilee	307	
Softer Tan	308	
Storm Cloud	309	
Rice Grain	310	
Ramie	311	
Favorite Tan	312	
High Tea	314	
Stone Reflections	315	
Dovetail Reflections	316	
Yorkshire	317	
Coriander	318	
Snowcap	319	
Salem	320	
Burnt Sierra	321	
Drizzle	322	
Scroll	323	
Cumin	324	
Seagull	325	
Smoke	326	
Gunpowder Blue	327	
Starlight Silver	329	
Martini Reflections	330	
Laminate White	332	
Steel Wool	334	
Kettle Black	335	
White Velvet	336	
Simply White	337	
Dark Bronze **	338	

****Due to the semi-transparent nature of clear coat paint finish, the substrate material, as well as markings from the manufacturing process may be visible through the finish. For warranty information, please refer to the Inscape North American warranty on inscapesolutions.com**

Textured colors

Available Unavailable

Accent paint collection

Standard colors are prefixed with a 'A'.

Name	Color code
Peony	A339
Lilac	A340
Amethyst	A341
Mulberry	A342
Plum	A343
Citrine	A344
Canary	A345
Lotus	A346
Monarch	A347
Coral	A348
Amaryllis	A349
Apricot	A350
Cantaloupe	A351
Poppy	A352
Caliche	A353
Obsidian	A354
Dahlia	A355
Honeydew	A356
Sage	A357
Hummingbird	A358
Spring	A359
Marimo	A360
Fern	A361
Azure	A362
Wave	A363
Lapis Blue	A364
Atoll	A365
Papillon	A366
Lagoon	A367
Night Sky	A368
Aqua	A369
Inscape Teal	A370

Left blank intentionally.

Care and Maintenance
US Price List
September 2018

Care and maintenance

General Info

The following information provides general guidelines for cleaning and maintaining Inscape products including: Worksurfaces, Tables, Tiles, Trim, Screens, Storage and Accessories.

Worksurfaces, Tables & Storage Nuform

Nuform surfaces are manufactured by thermoforming a polymer sheet around an MDF substrate. The polymer sheet is surface-coated with a scratch resistant film.

- For general cleaning, use warm soapy water or a mild, non-abrasive household cleanser such as "Vim" or "Windex"
- Tougher stains, such as ink, may be removed with methyl hydrate
- Do not use abrasive cleansers or highly solvent based chemicals such as gasoline, acetone or toluene as they may scratch or affect the surface appearance.
- Do not place hot appliances directly on Nuform surfaces
- Although Nuform is scratch resistant, avoid dragging sharp objects across the surface
- Light scratches may be buffed from the foil surface by using a 400-600 grit wet sandpaper under light hand pressure in circular motions or by using a 3M Scotch Brite Pad (green color only) under light hand pressure in circular motions. Note: Under no circumstances should power buffing tools be used.
- Chips and deep scratches may be repaired by a professional touch-up service. Minor imperfections should be addressed immediately as neglect can result in more serious problems that could void the warranty.
- Optimal temperature range for storing of Nuform surfaces is 41°F to 86°F

Laminate

High pressure laminate is available for use on surfaces and is optional on laminate storage door fronts. Low pressure laminate is available for use on laminate storage cases and door fronts. Both laminate options are laminated to particleboard and includes a color coordinated edge banding.

- Dust laminated surfaces off prior to cleaning
- For general cleaning, use a damp cloth with warm soapy water or a mild, non-abrasive household cleanser such as "Vim" or "Windex". Remember to wipe the surface with the grain using a dry soft cloth.
- In addition, laminate storage may also be cleaned with "Glass Plus", "Dawn", "Pledge" or "Mr. Clean"
- An eraser may assist with removing ink marks
- Do not use abrasive cleaners or bleaching cleansers as they may scratch or affect the surface appearance
- Take note that any product with Hydrochloric, Sulfuric, or Phosphoric acid may permanently damage the surface
- Although high pressure plastic laminates are resistant to scratching and wear, avoid dragging sharp objects across the surface
- Although laminates are heat resistant, a hot pad should be placed under appliances

Veneer

Wood Veneer surfaces are sealed and top coated with an open pore, catalyzed lacquer and are edged in 0.25" thick, same species solid hardwood. Like all natural products, wood Veneer surfaces may vary slightly in grain, texture and color. For this reason, minor variations between pieces can be expected.

- Use a coaster for beverages
- Dust surfaces with a dry cloth in the direction of the grain
- For dirtier surfaces, use warm soapy water and a soft cloth
- Do not use abrasive cleaning products as they may scratch or affect the surface appearance.
- Although waxing and polishing is not necessary, waxing and polishing products may be applied if care is taken to avoid wax build-up which may cloud the finish
- Blot spills up immediately
- Exposure to strong sunlight should be avoided since fading may result
- Avoid exposure to extreme heat, cold or humidity
- Avoid dragging sharp objects across the surface
- Chips and scratches may be repaired by a professional touch-up service

Tiles, Screen and Storage Upholstered

- Vacuum or lightly brush panel fabrics to remove dirt build-up
- Promptly remove stains by blotting, not rubbing the fabric to retain pile texture
- Fabric may be cleaned with mild water-free solvents or water-based cleaning agents or foam. Always follow the manufacturer's instructions and test clean a non-visible area first

Glazed Tiles

- Glazed tiles are available in both acrylic and tempered glass
- Clean acrylic with a clean soft cloth and warm soapy water
- Clean tempered glass with a mild window cleaner such as "Windex"

Painted

- Clean with a soft damp cloth and warm soapy water
- Paint touch-up kits are available to repair minor scratches
- If a product has an unsightly scratch or dent, the damaged product can easily be switched with another product in a less visible area

Nuform Tiles

- Nuform tiles are manufactured by thermoforming a polymer sheet around an MDF substrate. The polymer sheet is surface-coated with a scratch resistant film.
- Refer to "General Care" instructions for Nuform Worksurfaces, Tables & Storage for guidelines on maintaining Nuform tiles

Trim

Panel Trim

- Clean woodgrain vinyl trim, painted and textured trim with a soft damp cloth
- Touch up paint is available to repair minor scratches on painted trim finishes

Accessories

Whiteboards

- Use only dry erase markers with whiteboards
- Clean whiteboards with eraser and cleaner formulated for whiteboards
- INSCAPE recommends using Sanford Expo Dry Erase Markers and Sanford Whiteboard Cleaner

Sliding Doors

- Clean with a clean, dry, absorbent, lint-free, nonabrasive cloth
- DO NOT USE rayon or polyester cloths which can scratch the plastic

Bin/Shelf-mounted Task Light Fixtures

- Include a 120V/60HZ magnetic ballast. Replacement ballasts can be purchased from any electrical supply store.

inscape

67 Toll Road
Holland Landing, Ontario
L9N 1H2 Canada

T 905 836 7676
F 905 836 6000

inscapesolutions.com

© Inscape Corporation 2016™

® trademarks of Inscape Corporation. Patents may be pending. Certain names, words, logos and graphics or designs contained herein are trademarks or service marks of Inscape Corporation.